

United Nations Environment Programme
Mediterranean Action Plan
Regional Activity Centre for Specially Protected Areas

PROCEEDINGS OF THE SECOND
MEDITERRANEAN SYMPOSIUM ON
MARINE VEGETATION

ATHENS, 12-13 DECEMBER 2003

*ACTES DU DEUXIEME SYMPOSIUM
MEDITERRANEEN SUR LA VEGETATION
MARINE*

ATHENES, 12-13 DECEMBRE 2003



UNEP



H.C.M.R.
Hellenic Centre for Marine Research
Institute of Oceanography

September 2006

United Nations Environment Programme
Mediterranean Action Plan
Regional Activity Centre for Specially Protected Areas



PROCEEDINGS OF THE SECOND
MEDITERRANEAN SYMPOSIUM ON
MARINE VEGETATION

ATHENS, 12-13 DECEMBER 2003

*ACTES DU DEUXIEME SYMPOSIUM
MEDITERRANEEN SUR LA VEGETATION
MARINE*

ATHENES, 12-13 DECEMBRE 2003



H.C.M.R.
HELLENIC CENTRE FOR MARINE RESEARCH
INSTITUTE OF OCEANOGRAPHY

September 2006



UNEP



RAC/SPA

PROCEEDINGS OF THE SECOND MEDITERRANEAN SYMPOSIUM ON MARINE VEGETATION

(ATHENS, 12-13 DECEMBER 2003)

ACTES DU DEUXIEME SYMPOSIUM MEDITERRANEEN SUR LA VEGETATION MARINE

(ATHENES, 12-13 DECEMBRE 2003)

The finding, interpretation and the presentation of the material, expressed in this publication are entirely those of authors and should not be attributed to UNEP.

Les informations et la présentation des données, qui figurent dans cette publication sont celles des auteurs et ne peuvent être attribuées au PNUÉ.

Copyright : © 2006 United Nations Environment Programme, Mediterranean Action Plan, Regional Activity Centre For Specially Protected Areas (RAC/SPA).

© 2006 Programme des Nations Unies pour l'Environnement, Plan d'Action pour la Méditerranée, Centre d'Activités Régionales pour les Aires Spécialement Protégées (CAR/ASP)

This publication may be reproduced in whole or in part, and in any form for educational or non-profit purposes, without special permission from the copyright holder, provided acknowledgement of the source is made. No use of this publication may be made, for resale or for any other commercial purpose whatsoever, without permission in writing from UNEP.

La présente publication peut être reproduite en tout ou partie, et sous n'importe quelle forme, dans un objectif d'éducation et à titre gracieux, sans qu'il soit nécessaire de demander une autorisation spéciale au détenteur du copyright, à condition de faire mention de la source. La présente publication ne peut être utilisée, pour la vente ou à toutes fins commerciales, sans un accord écrit préalable du PNUÉ.

Citation : UNEP - MAP - RAC/SPA, 2006. Proceedings of the second Mediterranean symposium on marine vegetation (Athens, 12-13 December 2003). RAC-SPA edit., Tunis : 255p.

PNUE - PAM - CAR/ASP, 2006. Actes du deuxième symposium méditerranéen sur la végétation marine (Athènes, 12-13 Décembre 2003). CAR/ASP édit., Tunis : 255p.

Cover photo credits / Crédit photographique: Unidad de Biología Marina, University of Alicante (Spain)

Printed by / Imprimé par:

SIMPACT Imprimerie & édition, Tunis

FOREWORD

The Mediterranean Sea is characterized by its large specific biodiversity and high rate of endemism. The Action Plan for the Conservation of Marine Vegetation in the Mediterranean Sea, adopted by the Contracting Parties to the Barcelona Convention in 1999, aims to ensure the protection of the species of marine vegetation and vegetal assemblages in the Mediterranean.

The enhancing of scientific research, with the collaboration between the Mediterranean countries by the transferring of technologies and working tools and by spreading knowledge related to plant diversity, contributes in this way to the implementation of the Action Plan.

This publication of the Proceedings of the Second Mediterranean Symposium on Marine Vegetation is the product of scientists' research work, exchange of experience and communication of data to preserve the common natural heritage of the countries of the region.

The Regional Activity Centre for Specially Protected Areas (RAC/SPA), by enhancing inter-country cooperation, will continue to coordinate the efforts made to protect the Mediterranean's marine vegetation.

The Director of RAC/SPA

AVANT-PROPOS

La Mer Méditerranée se caractérise par une diversité biologique spécifique particulièrement importante et remarquable avec un taux d'endémisme élevé. Ainsi le Plan d'Action sur la Conservation de la Végétation Marine en Mer Méditerranée, adopté par les Parties contractantes à la Convention de Barcelone en 1999, vise à assurer la protection des formations et espèces végétales marines en Méditerranée.

Le renforcement de la recherche scientifique, avec la collaboration entre les pays riverains de la Méditerranée par le biais de transfert des technologies, d'outils de travail et par la diffusion de connaissances relatives à la diversité végétale contribue de cette manière à la mise en œuvre dudit Plan d'Action.

Cette publication des Actes du Deuxième Symposium Méditerranéen sur la Végétation Marine constitue le produit de travaux de recherche de scientifiques, d'échanges d'expérience et de communication de données en vue de conserver le patrimoine naturel commun des pays de la région.

Le Centre d'Activités Régionales pour les Aires Spécialement Protégées (CAR/ASP), par un renforcement des coopérations entre les pays continuera à coordonner les divers efforts pour la concrétisation de la sauvegarde de la végétation marine du bassin méditerranéen.

Le Directeur du CAR/ASP

CONTENTS/SOMMAIRE

Programme	9
Posters displayed	13
Report of the Second Mediterranean Symposium on Marine Vegetation	15
<i>Rapport du Deuxième Symposium Méditerranéen sur la Végétation Marine</i>	17
1. KEY-NOTE SPEECHES / CONFÉRENCES INTRODUCTIVES	19
BOUDOURESQUE C.F., LERICHE A., BERNARD G. & BONHOMME P. Mapping marine vegetation distribution: An overview	21
BOUDOURESQUE C.F. Anthropogenic impacts on marine vegetation in the Mediterranean	34
GIACCONI G., FURNARI G. & MARIO C. Floristic similarity and discontinuity in phytogeographic Mediterranean regions	55
2. ORAL PRESENTATIONS / COMMUNICATIONS ORALES	
SESSION «BIOLOGY, ECOLOGY AND INVENTORIES OF SPECIES AND ASSEMBLAGES» SESSION «BIOLOGIE, ECOLOGIE ET INVENTAIRES DES ESPÈCES ET DES FORMATIONS»	75
BOTTALICO A., DELLE FOGLIE C.I. & PERRONE C. New records along the Apulian coasts	77
CIRIK Ş. & AKÇALI B. The situation of <i>Caulerpa</i> species around Turkish Coasts	83
DJELLOULI A.S., LANGAR H. & EL ABED A. Mollusques ascoglosses associés aux peuplements de <i>Caulerpa racemosa</i> en Tunisie: espèces observées et description des effets trophiques	88
EL ASMI-DJELLOULI Z., DJELLOULI A.S., PERGENT-MARTINI C., PERGENT G., ABDELJAOUED S. & EL ABED A. Interactions entre l'herbier à <i>Posidonia oceanica</i> et l'hydrodynamisme au sein de la baie de Monastir (Tunisie orientale)	93
LANGAR H., DJELLOULI A.S. & EL ABED A. <i>Caulerpa taxifolia</i> : Situation connue en Tunisie au 31 juillet 2003	100

MANGIALAJO L., BARBERIS G. & CATTANEO-VIETTI R. Contribute to the knowledge of macroalgal biodiversity of the Ligurian Coast	107
MISSAOUI H., MAHJOUR M.S. & CHALGHAF M. Apparition de la phanérogame <i>Halophila stipulacea</i> dans le golfe de Gabès (Tunisie)	115
SESSION «MAPPING MARINE VEGETATION DISTRIBUTION» SESSION «CARTOGRAPHIE DE LA RÉPARTITION DE LA VÉGÉTATION MARINE»	119
BELSHER T., HOULGATTE E. & BOUDOURESQUE C. F. Cartographie de la prairie à <i>Posidonia oceanica</i> et des principaux faciès sédimentaires marins du Parc national de Port-Cros (Var, France, Méditerranée)	121
CINELLI F., ACUNTO S., BALATA D. & PIAZZI L. La cartographie des herbiers à <i>Posidonia oceanica</i> en Italie	131
EL ASMI S., RAIS C., ROMDHANE M.S. & EL HERRY S. Cartographie du récif-barrière de posidonies de la baie de Sidi Rais (côtes nord-orientales de La Tunisie)	136
TORRAS X., PINEDO S., GARCIA M. MANGIALAJO L. & BALLESTEROS E. Assessment of coastal environmental quality based on littoral community cartography: methodological approach	145
VARKITZI I., PANAYOTIDIS P. & MONTESANTO B. Cystoseira spp. associations in the North-eastern Mediterranean : The case of evoikos Gulf (central Aegean Sea, Greece)	154
SESSION «ANTHROPOGENIC IMPACTS ON MARINE VEGETATION IN THE MEDITERRANEAN» SESSION «IMPACTS ANTHROPIQUES SUR LA VEGETATION MARINE DE MEDITERRANEE»	161
EL HERRY S., ROMDHANE M.S., RAIS C. & BEN REJEB JENHANI A. Caractérisation de l'état des herbiers à <i>Posidonia oceanica</i> du Nord-Est des îles Kerkennah (Tunisie)	163
GUALA I., ESPOSITO A. & BUIA M.C. Macroalgal assemblages in the Gulf of Naples : Spatial variability in relation to anthropogenic disturbance	168
LAFABRIE C., ANDRAL B., FERRAT L., LEONI V., PERGENT-MARTINI C. & SAUZADE D. Biomonitoring of environmental metallic contamination	175
MENSI F., KSOURI J., DRAIEF N. & EL ABED A. Effets de l'incorporation de l' <i>Ulva</i> sp. dans l'alimentation du <i>Tilapia</i> du Nil	181

ORFANIDIS S., TSIAGGA E. & STAMATIS N. Marine benthic macrophytes as bioindicators of eutrophication in selected Eastern Macedonian and Thrace lagoons, North Greece	186
PANAYOTIDIS P., MONTESANTO B. & ORFANIDIS S. Phytobenthos as a Quality Element for the evaluation of the ecological Status: a case study of the implementation of the Water Frame Directive (2000/60/EC) in the Mediterranean Ecoregion	193
PERGENT G., OUERGHI A., PASQUALINI V., PERGENT-MARTINI C., SKOUFAS G., SOURBES L. & TSIRIKA A. Caractérisation des herbiers à <i>Posidonia oceanica</i> dans le Parc Marin National de Zakynthos (Grèce)	199
PINEDO S., GARCIA M., SATTÀ P., TORRAS X. & BALLESTEROS E. Littoral benthic communities as indicators of environmental quality in the Mediterranean waters	205
SALOMIDI M., PANCUCCI-PAPADOPOULOU M.A., HATIRIS G.A. & PANAYOTIDIS P. Rapid assessment of the ecological status of a Greek coastal area based on phytobenthos: preliminary results	211
SPATHARIS S., PANAYOTIDIS P., DANIELIDIS D. & MONTESANTO B. Application of ecological indices on phytobenthos data for the implementation of the water framework directive (WFD, 2000/60/EC)	217
TURK R. Overview of the activities aimed at a long-term conservation of The <i>Posidonia oceanica</i> meadow on the Slovenian Coast	223
3. POSTER ABSTRACTS.....	227
ARGYROU M., BAYLE J.T., RAIS C., RAMOS-ESPLÁ A.A., SANCHEZ-JEREZ P. & VALLE C. Marine vegetation assemblages and benthic bionomy in Cyprus	229
ARGYROU M. & HADJICHRISTOPHOROU M. Marine macrophytobenthos of Cyprus	230
BAYLE J.T., BEN MUSTAPHA K., BOUAJINA A., GUELLOUZ S., LIMAM A., RAIS C., RAMOS-ESPLÁ A.A., SANCHEZ-JEREZ P. & VALLE C. Marine Vegetation assemblages and Benthic bionomy in the Zembra-Zembretta National Park (Tunisia)	231
KSOURI J., MENSİ F., REKHIS J., ABASSI A. & OUIJENE R. Les végétaux marins des ressources exploitables en nutrition animale. Application à la formulation d'aliments pour les monogastriques	232

BITAR G., TORCHIA G., BADALAMENTI F., CEBRIAN-MENCHERO D., DUPUY DE LA GRANDRIVE R. & M. FOULQUIE Mission relative au developpement d'Aires Monnes protégées sur les côtes syriennes	234
MAKOVEC T. & TURK R. Mapping of the <i>Posidonia oceanica</i> meadow on the Slovenian Coast	236
MARTINEZ B., VERGÉS TRAMULLAS A., PRADO P., ROMERO J. & ALCOVERRO T. Seagrass ecosystems as biological indicators. A comparison of two approaches: leaf epiphyte taxonomy and a combined set of biological descriptors	238
PANTAZI M., PANAYOTIDIS P., MONTESANTO B., DANEILIDIS D. & ECONOMOU A. Preliminary phytobenthos biodiversity study of marine sites of the Greek NATURA 2000 network	239
PERGENT-MARTINI C., LEONI V., PASQUALINI V., ARDIZZONE G., BALESTRI E., BEDINI R., BELLUSCIO A., BELSHER T., BORG J.A., BOUDOURESQUE C.F., BOUMAZA S., BOUQUEGNEAU J.M., BUIA M.C., CALVO S., CEBRIAN J., CHARBONNEL E., CINELLI F., COSSU A., DURAL B., FRANCOUR P., GOBERT S., MOSTAFA H., LEPOINT G., MEINESZ A., MOLENAAR H., PANAYOTIDIS P., PEIRANO A., PERGENT G., PIAZZI L., RELINI G., ROMERO J., SANCHEZ-LIZASO J., SEMROUD R., SHEMBRI P.J., SHILI A. & VELIMIROV B. Descriptors of <i>Posidonia oceanica</i> meadows: General overview	240
RIVEILL S., DJABOU H., HAMRIT R. & EL ABED A. Les microatolls de la lagune d'El Biban : Caractérisation de faciès rares d'herbiers à <i>Posidonia oceanica</i>	241
SHILI A. & BEN MAIZ N. Diversité spécifique des peuplements phytobenthiques de la lagune de Bou Ghrara (Tunisie méridionale)	242
SKOUFAS G. & TSIRIKA A. Preliminary results of the epibiotic flora on <i>Eunicella singularis</i> (Gorgonacea) colonies from the North Aegean Sea	244
TSIRIKA A., PATOUCHEAS D. & HARITONIDIS S. Contribution to the knowledge of the benthic marine macroalgae from Mani region (Messiniakos Gulf, Greece)	245
LIST OF PARTICIPANTS	247

PROGRAMME

Friday 12 December 2003

09:00 Opening Session

- Welcome speeches: V. PAPATHANASSIOU (Director of NCMR) and S. CIVILI (UNEP/MAP Coordinating Unit)
- Presentation on the "Action Plan for the Conservation of Marine Vegetation in the Mediterranean Sea" and on the "Symposium Programme" by C. RAIS (RAC/SPA)

09:30 – 13:00 Session 2 : Biology, Ecology and Inventories of species and assemblages (Chairperson: G. GIACCONE)

- Keynote speech on "Floristic similarity and discontinuity in phytogeographic Mediterranean regions" (G. GIACCONE, FURNARI G. & MARIO C.)
- Oral presentation session
 - New records along the Apulian coasts (BOTTALICO A., DELLE FOGLIE C.I. & PERRONE C.)
 - Mollusques ascoglosses associés aux peuplements de *Caulerpa racemosa* en Tunisie : espèces observées et description des effets trophiques (DJELLOULI A.S., LANGAR H. & EL ABED A.)
 - Contribute to the knowledge of macroalgal biodiversity of the Ligurian Coast (MANGIALAJO L., BARBERIS G. & CATTANEO-VIETTI R.)
 - The situation of *Caulerpa* species around Turkish Coasts (CIRIK Ş. & AKÇALI B.)

Discussion

- Interactions entre l'herbier à *Posidonia oceanica* et l'hydrodynamisme au sein de la baie de Monastir (Tunisie orientale) (EL ASMI-DJELLOULI Z., DJELLOULI A.S., PERGENT-MARTINI C., PERGENT G., ABDELJAOUED S. & EL ABED A.)
- *Caulerpa taxifolia* : Situation connue en Tunisie au 31 juillet 2003 (LANGAR H., DJELLOULI A.S. & EL ABED A.)
- Apparition de la phanérogame *Halophila stipulacea* dans le golfe de Gabès (Tunisie) (MISSAOUI H., MAHJOUB M.S. & CHALGHAF M.)

Discussion

13:00 - 14:30 Lunch break

14:30 - 14:45 "The R.A.M.O.G.E Agreement" (F. PLATINI)

14:45 - 17:00 Session 3 : Mapping marine vegetation distribution (Chairperson : C.F. BOUDOURESQUE)

- Keynote speech on "Mapping marine vegetation distribution: An overview" (BOUDOURESQUE C.F., LERICHE A., BERNARD G. & BONHOMME P.)

- Oral presentation session

- La cartographie des herbiers à *Posidonia oceanica* en Italie (CINELLI F., ACUNTO S., BALATA D. & PIAZZI L.)
- Cartographie du récif-barrière de posidonies de la baie de Sidi Rais (côtes nord-orientales de la Tunisie) (EL ASMI S., RAIS C., ROMDHANE M.S. & EL HERRY S.)

Discussion

- Biocénoses du Parc National de Port-Cros: cartographie et proposition de gestion par SIG (BELSHER T.)
- Observations on the structure of *Cystoseira* communities along a gulf of Northeastern Mediterranean (central Aegean Sea, Greece) (VARKITZI I., PANAYOTIDIS P. & MONTESANTO B.)
- Assessment of coastal environmental quality based on littoral community cartography: methodological approach (TORRAS X., PINEDO S., GARCIA M. MANGIALAJO L. & BALLESTEROS E.)

Discussion

17:15 - 18:45 Roundtable 1: Standardisation of mapping techniques (Chairperson: G. PERGENT)

Saturday 13 December 2003

09:00 - 13:00 Session 4: Anthropogenic Impacts on Mediterranean marine vegetation
(Chairperson: R. SEMROUD)

- Keynote speech on "Anthropogenic impacts on marine vegetation in the Mediterranean" (C.F. BOUDOURESQUE)
- Oral presentation session

- Caractérisation de l'état de l'herbier à *Posidonia oceanica* du Nord-est des îles Kerkennah (Tunisie) (EL HERRY S., ROMDHANE M.S., RAIS C. & BEN REJEB JENHANI A.)
- Biomonitoring of environmental metallic contamination (LAFABRIE C., ANDRAL B., FERRAT L., LEONI V., PERGENT-MARTINI C. & SAUZADE D.)
- Caractérisation des herbiers à *Posidonia oceanica* dans le Parc Marin National de Zakynthos (Grèce) (PERGENT G., OUERGHI A., PASQUALINI V., PERGENT-MARTINI C., SKOUFAS G., SOURBES L. & TSIRIKA A.)

Discussion

- Macroalgal assemblages in the Gulf of Naples: Spatial variability in relation to anthropogenic disturbance (GUALA I., ESPOSITO A. & BUJA M.C.)
- Marine benthic macrophytes as bioindicators of eutrophication in selected Eastern Macedonian and Thrace lagoons, North Greece (ORFANIDIS S., TSIAGGA E., STAMATIS N.)
- Phyto-benthos as a Quality Element for the ecological Status Evaluation: a case study of the implementation of the Water Frame Directive (2000/60/EC) in the Mediterranean Ecoregion (PANAYOTIDIS P., MONTESANTO B. & ORFANIDIS S.)

- Littoral benthic communities as indicators of environmental quality in the Mediterranean waters (PINEDO S., GARCIA M., SATTA P., TORRAS X. & BALLESTEROS E.)
- Rapid assessment of the ecological status of a Greek coastal area based on phytobenthos: preliminary results (SALOMIDI M., PANCUCCI-PAPADOPOULOU M.A., HATIRIS G.A. & PANAYOTIDIS P.)
- Application of biotic indices on phytobenthos data for the implementation of the water frame directive (WFD, 2000/60/EC) (SPATHARIS S. & PANAYOTIDIS P.)

Discussion

- Effets de l'incorporation de l'*Ulva* sp. dans l'alimentation de la *Tilapia* du Nil (MENSI F., KSOURI J., DRAIEF N. & EL ABED A.)
- Overview of the activities aimed at a long-term conservation of *Posidonia oceanica* meadow on the Slovenian coast (TURK R.)

Discussion

13:00 –14:30 Lunch break

Working group 1: Elaboration of Taxonomy tools for Mediterranean marine vegetation (Chairperson: G. BITAR)

Working group 2: *Posidonia* meadows

14:30 – 14:45 "The impact of the Red Sea herbivore invaders on the food web in the eastern Mediterranean" (M. GOREN)

14:45 – 16:00 **Round table 2:** The phytobenthos as quality element for the evaluation of the ecological quality (Chairperson: P. PANAYOTIDIS)

16:30 – 17:30 **Session 5: Conclusions and recommendations**

- Recommendations of the Symposium (C. RAIS)
- Scientific objectives of the Third Mediterranean Symposium on Marine Vegetation

17:30 Closure of the Symposium

POSTERS DISPLAYED

- Marine vegetation assemblages and benthic bionomy in Cyprus (ARGYROU M., BAYLE J.T., RAIS C., RAMOS-ESPLÁ A.A., SANCHEZ-JEREZ P. & VALLE C.)
- Marine macrophytobenthos of Cyprus (ARGYROU M. & HADJICHRISTOPHOROU M.)
- Contribution to the knowledge of the Marine Vegetation assemblages end Benthic bionomy in the Zembra-Zembretta National Park (Tunisia) (BAYLE J.T., BEN MUSTAPHA K., BOUAIJINA A., GUELLOUZ S., LIMAM A., RAIS C., RAMOS-ESPLÁ A.A., SANCHEZ-JEREZ P. & VALLE C.)
- Biodiversity along the Syrian coasts (DE LA GRANDRIVE R., FOULQUIE M. & BITAR G.)
- Les végétaux marins des ressources exploitables en nutrition animale. Application à la formulation d'aliments pour les monogastriques (KSOURI J., MENSI F., REKHIS J., ABASSI A. & OUIJENE R.)
- Mapping of the *Posidonia oceanica* meadow on the Slovenian coast (MAKOVEC T. & TURK R.)
- Seagrass ecosystems as biological indicators. A comparison of two approaches: leaf epiphyte taxonomy and a combined set of biological descriptors (MARTINEZ B., VERGÉS TRAMULLAS A., PRADO P., ROMERO J. & ALCOVERRO T.)
- Preliminary phytobenthos biodiversity study of marine sites of the Greek NATURA 2000 network (PANTAZI M., PANAYOTIDIS P., DANEILIDIS D., MONTESANTO B. & ECONOMOU A.)
- Descriptors of *Posidonia oceanica* meadows: General overview (PERGENT-MARTINI C., LEONI V., PASQUALINI V., ARDIZZONE G., BALESTRI E., BEDINI R., BELLUSCIO A., BELSHER T., BORG J.A., BOUDOURESQUE C.F., BOUMAZA S., BOUQUEGNEAU J.M., BRANKO V., BUIA M.C., CALVO S., CEBRIAN J., CHARBONNEL E., CINELLI F., COSSU A., DURAL B., FRANCOUR P., GOBERT S., MOSTAFA H., LEPOINT G., MEINESZ A., MOLENAAR H., PANAYOTIDIS P., PEIRANO A., PERGENT G., PIAZZI L., RELINI G., ROMERO J., SANCHEZ-LIZASO J., SEMROUD R., SHEMBRI P.J. & SHILI A. & VELIMIROV B.)
- Littoral Benthic communities as indicators of environment quality in Mediterranean waters (PINEDO S., GARCIA M., SATTI M.P., TORRAS X. & BALLESTEROS E.)
- Caractérisation de faciès rares d'herbiers à posidonies: les microatolls de la lagune d'El Biban (RIVEILL S., DJEBO H., HAMRIT R. & EL ABED A.)

- Diversité spécifique des peuplements phytobenthiques de la lagune de Bou Ghrara (Tunisie méridionale) (SHILI A. & BEN MAIZ N.)
- Preliminary results of the epibiotic flora on *Eunicella singularis* (Gorgonacea) colonies from the North Aegean Sea (SKOUFAS G. & TSIRIKA A.)
- Assessment of coastal environmental quality based on littoral community cartography: methodological approach (TORRAS X., PINEDO S., GARCIA M., MANGIALAJO L. & BALLESTEROS E.)
- Contribution to the knowledge of the benthic marine macroalgae from Mani region (Messiniakos Gulf, Greece) (TSIRIKA A., PATOUCHEAS D. & HARITONIDIS S.)

REPORT ON THE SECOND MEDITERRANEAN SYMPOSIUM ON MARINE VEGETATION

1. Introduction

The adoption in 1999 by the Contracting Parties to the Barcelona Convention of the Action Plan for the Conservation of Marine Vegetation in the Mediterranean Sea aimed at ensuring the protection of the macroscopic marine plant species and plant assemblages in the Mediterranean which may be considered as natural monuments, and preventing their degradation by maintaining them in a favourable state of conservation.

In the context of the said Action Plan, the Regional Activity Centre for Specially Protected Areas (RAC/SPA) organised for the second time a Mediterranean Symposium on Marine Vegetation on 12 and 13 December 2003 in Athens, Greece.

2. Introductions and thanks

ORGANISING COMMITTEE: Souha EL ASMI
Frédéric PLATINI
Panayotis PANAYOTIDIS
Chedly RAIS

SCIENTIFIC COMMITTEE: Naceur BEN MAIZ
Ghazi BITAR
Charles-François BOUDOURESQUE
Giuseppe GIACCONE
Panayotis PANAYOTIDIS
Gérard PERGENT
Chedly RAIS
Rachid SEMROUD
Leonardo TUNESI

The RAC/SPA would like to thank all the participants at this Symposium, the Organising Committee and the Scientific Committee for their fruitful collaboration, and also thanks the Director of the NCMR (National Centre for Marine Research) for his warm welcome.

3. Progress of work

The Symposium started with an opening session, with speeches of welcome to the participants made by Mr. Papanthassiou, the Director of the NCMR, and Mr. Civili, from the UNEP/MAP Coordinating Unit.

During this session, Mr. Rais, the RAC/SPA Scientific Director, presented the Action Plan for the Conservation of Marine Vegetation in the Mediterranean Sea and the programme of the Symposium.

This programme was organised around three sessions which dealt with the following subjects:

- *Biology, ecology and inventory of plant species and assemblages*
- *Mapping the marine vegetation and its distribution*
- *Anthropic impacts on Mediterranean marine vegetation.*

The three sessions were in the form of oral presentations of the work of each participant, backed by articles prepared according to the instructions given by the organisers.

Participants' posters were displayed during the entire period of the Symposium and backed by summaries of the work done.

Three introductory lectures by Prof. Boudouresque and Prof. Giaccone started off each of the three sessions.

Working groups and round tables were planned to discuss the various subjects tackled at the Symposium.

4. Recommendations and conclusions

The discussions of the meetings of working groups and round tables, and those that followed each session, led to the following recommendations and conclusions:

• Standardisation of mapping methods

- Make effective maps that are easy to use, fairly cheap, and reliable by setting up a Reliability Index.
- As far as possible, add quantitative and also qualitative data that will enable the state of the plant assemblages to be assessed for optimum use of mapping.
- Develop mapping of other plant assemblages, particularly those listed in the Action Plan for the Conservation of Marine Vegetation in the Mediterranean.
- As far as possible, standardise methods of mapping.
- Integrate the entirety of the mapping data in a georeferential database that is standardised around the Mediterranean basin. This system of geographic information will be an indispensable tool for the integrated management of the coastal area.
- Set up working groups by subject (standardisation of mapping methods and descriptors, formatting and circulation of information) and form a Scientific and Technical Committee to advise the various countries in making their national maps.

• Elaboration of tools for the taxonomy of the marine vegetation

- Elaborate an inventory of specialists through a directory of specialists in marine vegetation that is already available on the website.
- Translate and circulate the guide already produced by Prof. Giaccone and available at RAC/SPA.
- Make an inventory of national needs.
- Process via an observatory the information already acquired by RAC/SPA and make it available.

RAPPORT DU DEUXIEME SYMPOSIUM MEDITERRANEEN SUR LA VEGETATION MARINE

1. Introduction

L'adoption du Plan d'Action pour la Conservation de la Végétation Marine en Mer Méditerranée par les Parties contractantes à la Convention de Barcelone en octobre 1999, vise à assurer la conservation des espèces de végétaux marins macroscopiques et des formations végétales en Méditerranée qui peuvent être considérées comme monuments naturels et à éviter leur dégradation en les maintenant dans un état de conservation favorable.

Dans le cadre du-dit Plan d'Action, le Centre d'Activités Régionales pour les Aires Spécialement Protégées (CAR/ASP) a organisé pour la seconde fois le Symposium Méditerranéen sur la Végétation Marine, les 12 et 13 décembre 2003 à Athènes (Grèce).

2. Présentation et remerciements

COMITE D'ORGANISATION :
Souha EL ASMI
Frédéric PLATINI
Panayotis PANAYOTIDIS
Chedly RAIS

COMITE SCIENTIFIQUE :
Naceur BEN MAIZ
Ghazi BITAR
Charles-François BOUDOURESQUE
Giuseppe GIACCONE
Panayotis PANAYOTIDIS
Gérard PERGENT
Chedly RAIS
Rachid SEMROUD
Leonardo TUNESI

Le CAR/ASP souhaiterait remercier tous les participants à ce symposium, le comité d'organisation et le comité scientifique pour leur fructueuse collaboration et remercie aussi le Directeur du NCMR (National Centre for Marine Research) pour son cordial accueil.

3. Déroulement des travaux

Le symposium a débuté par une session d'ouverture avec des discours de bienvenue s'adressant aux participants de la part de M. PAPATHANASSIOU, Directeur du NCMR et M. CIVILI, de l'Unité de Coordination du PNUE/PAM.

Au cours de cette session M. RAIS, Directeur scientifique du CAR/ASP, a présenté le Plan d'Action pour la Conservation de la Végétation Marine en Mer Méditerranée et le programme du symposium.

Ce programme s'est organisé autour de trois sessions qui ont abordé les principaux thèmes suivants :

- *Biologie, Ecologie et Inventaire des espèces et des formations végétales*
- *Cartographie de la répartition de la végétation marine*
- *Impacts anthropiques sur la végétation marine de Méditerranée*

Les trois sessions se sont déroulées sous la forme de présentations orales des travaux de chaque participant soutenues par des articles préparés selon les instructions données par les organisateurs.

Les posters des participants ont été affichés pendant toute la durée du symposium et soutenus par des résumés des travaux effectués.

Trois conférences introductives présentées par le Prof. BOUDOURESQUE et le Prof. GIACCONE ont précédé chacune de ces trois sessions.

Des groupes de travail et des tables rondes ont été prévus pour discuter les différents thèmes abordés au symposium.

4. Recommandations et Conclusions

Les débats des réunions des groupes de travail, des tables rondes, et les discussions qui ont suivi chaque session ont abouti aux recommandations et conclusions suivantes:

• Standardisation des méthodes de cartographie

- *Réaliser des cartographies performantes faciles à mettre en œuvre, d'un coût réduit, et fiable par la mise en place d'un index de confiance (RI : reliability index).*
- *Ajouter dans la mesure du possible, des données quantitatives mais aussi qualitatives permettant d'évaluer l'état des formations végétales pour une utilisation optimale de la cartographie.*
- *Développer la cartographie des autres formations végétales, et notamment celles inscrites dans le Plan d'Action pour la Conservation de la Végétation Marine en Méditerranée.*
- *Standardiser, dans la mesure du possible, les méthodes pour élaborer les cartographies.*
- *Intégrer l'ensemble des données cartographiques dans une base de données géoréférencée et normalisée à l'échelle du bassin méditerranéen. Ce système d'informations géographiques apportera un outil indispensable dans le cadre d'une gestion intégrée de la zone côtière.*
- *Mettre en place des groupes de travail thématiques (normalisation des méthodes de cartographie et des descripteurs, mise en forme et diffusion de l'information) et constituer un «comité scientifique et technique» destiné à conseiller les différents pays dans la réalisation de leurs cartographies nationales.*

• Elaboration d'outils pour la taxonomie de la Végétation Marine

- *Elaborer un inventaire des spécialistes par le biais d'un répertoire des spécialistes de la végétation marine déjà disponible sur le site web.*
- *Traduire et diffuser le guide déjà réalisé par le Prof. Giaccone et disponible au CAR/ASP.*
- *Etablir un inventaire des besoins nationaux.*
- *Traiter par le biais d'un observatoire les informations déjà acquises par le CAR/ASP et les rendre disponibles.*

KEY-NOTES SPEECHES
CONFERENCES INTRODUCTIVES

MAPPING MARINE VEGETATION DISTRIBUTION: AN OVERVIEW

Charles-François BOUDOURESQUE¹, Agathe LERICHE¹, Guillaume BERNARD² and Patrick BONHOMME²

¹ Centre d'Océanologie de Marseille, UMR CNRS 6540, Campus of Luminy, Case 901, 13288 Marseilles Cedex 9, France
² GIS Posidonie, Campus of Luminy, Case 901, 13288 Marseilles Cedex 9, France

ABSTRACT

Vegetation mapping objectives (scientific knowledge, nature conservation, monitoring), scope, methods (satellite imagery, aerial photography, Cusi, side scan sonar, towed underwater camera, dredging, grabs, observations from small boats, diving, snorkelling), scale (from 1/460 000 to 1/320), accuracy and the kind of mapped vegetation (a species, a community, a landscape or a type of bottom) vary widely from one map to another. Despite the fact that hundreds of maps are available, it is doubtful whether many of them fulfil any of the possible purposes of cartography. Major criticisms are that they lack accuracy and that they are only qualitative (i.e. just presence or absence). In addition, maps of species or communities other than the seagrass *Posidonia oceanica* (e.g. *Cystoseira* and *Laminaria* forests) are scarce.

KEYWORDS: cartography, marine vegetation, sea grass.

INTRODUCTION

In the Mediterranean Sea, the oldest maps showing the marine vegetation seem to be those of Marion (1883) and Pruvot (1897). Since then, hundreds of maps have been produced, most of them remaining unpublished (grey literature).

Objectives (scientific knowledge, natural heritage conservation, monitoring), scope, methods, scale, accuracy and the kind of mapped vegetation (a species, a community, a landscape and even types of bottom) vary widely from one map to another, and have changed over time.

Cartography is highly time consuming and often involves costly means and large teams. Therefore, it is justifiable to tackle a sensitive question: are maps a powerful tool which can provide answers to important questions, or do they often prove disappointing and only serve the purpose of raising (and wasting) money?

WHY MAP VEGETATION?

There are three major objectives in mapping vegetation distribution. Firstly, to develop scientific knowledge of the vegetation and of its distribution: location, abundance, patterns along depth and latitudinal gradients, patterns of succession over time from pioneer stages to the climax. Secondly, to conserve the vegetation as a natural heritage.

It is a matter of identifying rare and threatened vegetation types, then localising them, with the aim of protecting them. In addition, maps constitute a valuable tool for the management of coastal areas: to know the location of rare and threatened vegetation types constitutes a basis for setting up new port facilities, sewage outfalls, submarine cables, sealines, etc... well away from the areas where they grow (Charbonnel *et al.*, 1995; Pasqualini *et al.*, 1999, 2000; Bernard *et al.*, 2003a). Thirdly, to monitor the possible changes over time of the range of climax communities, as biological indicators of human impact and of climate shift, under either anthropogenic or natural forcing (Pasqualini and Pergent-Martini, 1996; Boudouresque *et al.*, 2000).

SCALE AND METHODS

Two types of method need to be considered: those leading to discrete data and those leading to continuous data (Meinesz *et al.*, 1981; Colantoni *et al.*, 1982; Cinelli *et al.*, 1992; Bianchi and Peirano, 1995; Denis *et al.*, 2003; among others).

Examples of the first type of method are sounding leads (a method no longer used), dredges, grabs, submarines, scuba diving, snorkelling, boating (observation of the intertidal zone and the subtidal fringe from small boats) and towed underwater cameras (Table I). The accuracy depends upon the mesh size of the grid, whatever the depth (e.g. Marion, 1883; Pruvot, 1897; Bellan-Santini, 1964; Picard, 1965; Augier and Boudouresque, 1976; Meinesz and Laurent, 1980, 1982; Clarisse, 1984; Meinesz and Lefèvre, 1984; Bianconi *et al.*, 1987; Meinesz *et al.*, 1987; Bellone and Meinesz, 1995; Loquès *et al.*, 1995; Piazzini *et al.*, 1996; Meinesz *et al.*, 1998, 1999, 2001). As far as identification of the type of bottom (or vegetation) is concerned, it is generally unequivocal. However, this is less certain with sounding leads, dredges and grabs due to the fact that misinterpretation can result from the presence of drift material on the bottom.

Methods leading to the acquisition of continuous data are satellite imagery, aerial photography, Cusi (digital spectroradiometer) and side scan sonar (Table I) (e.g. Cuvelier, 1976; Cristiani, 1980; Calvo and Fradà Orestano, 1984; Gloux, 1984; Fredj *et al.*, 1990; Paillard *et al.*, 1993; Pasqualini, 1997; Jaubert *et al.*, 1999; Belsher and Houlgatte, 2000; Pérez-Blaya *et al.*, 2000; Bonhomme *et al.*, 2003). The contours are usually obvious, but the identification of the type of bottom within the contours often proves doubtful. In addition, depth is important for satellite imagery and aerial photography (Cristiani, 1980; Colantoni *et al.*, 1982; Ramos Esplá, 1984; Pasqualini *et al.*, 1998). In the north-western Mediterranean, satellite imagery and aerial photography are disappointing below 5 m and 15 m respectively (Meinesz *et al.*, 1981; Belsher *et al.*, 1985, 1988; Hoareau, 1988; Meinesz *et al.*, 1988, 1991; Paillard *et al.*, 1993; Bianchi and Peirano, 1995; Pasqualini *et al.*, 1999; but see Fredj *et al.*, 1990 and G. Pergent, pers. comm.). In contrast, side scan sonar is generally ineffective in shallow waters (Meinesz *et al.*, 1981; but see Bernard *et al.*, 2003b). For all continuous methods, accuracy is greatly improved when ground truth is performed (e.g. Colantoni *et al.*, 1982; Augier *et al.*, 1984; Ramos Esplá,

1984; Boudouresque *et al.*, 1985b; Meinesz *et al.*, 1988; Fredj *et al.*, 1990; Pergent-Martini and Pergent, 1990; Paillard *et al.*, 1993).

The scale of maps ranges from 1/460 000 to 1/320 (Table I). Data processing may include kriging (Francour and Marchadour, 1989; Pergent, 1990) and image processing (Pasqualini and Pergent-Martini, 1996). A set of standardized symbols for large scale maps of Mediterranean benthic communities has been proposed by Meinesz *et al.*, (1983).

Table 1. Some examples of maps of Mediterranean marine vegetation (species or communities) arranged according to scale. The scale was directly measured on authors' figures, so that it may differ from the scale they mentioned.

Locality or region	Scale	Method	Species or community	Reference
Gulf of Lions	1/460 000	Dredging	Miscellaneous	Pruvot (1897)
Corsica	1/250 000	Aerial photography, side scan sonar	<i>Posidonia oceanica</i>	Pasqualini (1997)
Provence (France)	1/225 000	Dredging	Miscellaneous	Marion (1883)
Monastir Bay (East Tunisia)	1/154 000	Snorkelling, diving	Miscellaneous	El Asmi-Djellouli <i>et al.</i> (2000)
Provence (France)	1/125 000 to 1/4 000	Photos, diving	<i>Posidonia oceanica</i>	Blanc (1975)
Bahía de Alicante (SE Spain)	1/115 380	Aerial photographs, diving	<i>Posidonia oceanica</i>	Ramos Esplá (1984)
French Riviera and French Catalonia	1/108 000 to 1/2 000	Diving	<i>Caulerpa taxifolia</i> , <i>C. racemosa</i>	Meinesz <i>et al.</i> (2003)
SE Marseilles (Provence, France)	1/86 140	Boating	<i>Cystoseira amentacea</i>	Bellan (Santini (1964)
Gulf of Marseilles (Provence, France)	1/72 000	Dredging	Miscellaneous	Picard (1965)
Côte Bleue (Provence, France)	1/50 000	Aerial photography	<i>Posidonia oceanica</i>	Bernard <i>et al.</i> (2000)
Gulf of Hyères (French Riviera, France)	1/50 000	Side scan sonar	<i>Posidonia oceanica</i>	Paillard <i>et al.</i> (1993)
Côte Bleue, W Marseilles (Provence, France)	1/36 360	Aerial photographs, side scan sonar, diving	<i>Posidonia oceanica</i>	Bonhomme <i>et al.</i> (2003)
French Mediterranean coast	1/33 300 to 1/5 000	Diving, snorkelling	<i>Posidonia oceanica</i>	Molinier and Picard (1952)
Stagnone, West Sicily (Italy)	1/31 250	Aerial photographs	<i>Posidonia oceanica</i>	Calvo and Frada Orestano (1984)
Liguria (Italy)	1/25 000	Miscellaneous	<i>Posidonia</i> , <i>Cymodocea nodosa</i>	Bianchi and Peirano (1995)
Montecristo, Gorgona, Giannutri, Capraia, Grosseto, Giglio, Scoglio d'Africa Islands, Tuscany, Italy	1/25 000	Side scan sonar, remotely operated vehicle with camera, diving	<i>Posidonia oceanica</i> , <i>Cymodocea nodosa</i>	Cinelli <i>et al.</i> (1992)
SE Marseilles (Provence, France)	1/20 833	boating	<i>Cystoseira amentacea</i>	Soltan (2001)
Porto Conte bay, Alghero (W Sardinia)	1/20 000	Satellite, diving	<i>Posidonia oceanica</i>	Fredj <i>et al.</i> (1990)
Porquerolles Island (French Riviera, France)	1/15 000	Satellite imagery, diving	<i>Posidonia oceanica</i>	Meinesz <i>et al.</i> (1991)
Golfe Juan and Lérins Islands, French Riviera (France)	1/10 714	Submarine	<i>Posidonia oceanica</i>	Meinesz and Laurent (1982)
Gulfs of Toulon and Giens (French Riviera, France)	1/10 000	Aerial photographs, side scan sonar, diving	Miscellaneous Paillard <i>et al.</i> (1993)	

Gulf of San Fiorenzo, Northern Corsica	1/10 000	Aerial photography	<i>Posidonia oceanica</i>	Pasqualini (1997)
French Riviera (France)	1/9 375	Submarine	<i>Posidonia oceanica</i>	Meinesz and Laurent (1980)
Elbu bay, Sandula nature reserve, Western Corsica	1/9 090	Diving	Miscellaneous	Meinesz <i>et al.</i> (1998)
Ischia and Procida Islands, Gulf of Naples (Italy)	1/8 000	Side scan sonar, diving	<i>Posidonia oceanica</i>	Colantoni <i>et al.</i> (1982)
Elbu bay, Scandula nature reserve, Western Corsica	1/7 810	Diving	<i>Posidonia oceanica</i>	Meinesz <i>et al.</i> (1987)
Menton to Cap d'Ail (French Riviera, France)	1/7 500	Aerial photographs, side scan sonar, underwater camera	Miscellaneous, incl. <i>Caulerpa taxifolia</i>	Belsher and Houlgatte (2000)
Scandula nature reserve, Western Corsica	1/ 5880	Boating	<i>Cystoseira amentacea</i> , <i>C. compressa</i> , <i>Lithophyllum byssoides</i>	Meinesz <i>et al.</i> (1999)
Calvi (W Corsica)	1/5 700	Snorkelling	<i>Cystoseira brachycarpa</i>	Clarisse (1984)
Port-Cros Island (French Riviera, France)	1/5 400	Boating	<i>Cystoseira amentacea</i> , <i>C. compressa</i> , <i>Lithophyllum byssoides</i> , <i>Rissoella verruculosa</i>	Meinesz <i>et al.</i> (2001)
Juan-les-Pins to Golfe Juan (French Riviera, France)	1/5 000	Aerial photography, diving	Seagrasses	Meinesz and Simonian (1983)
Port-Cros Island (French Riviera, France)	1/5 000	Aerial photography, snorkelling, diving	Miscellaneous	Augier and Boudouresque (1970)
Porquerolles Island (French Riviera, France)	1/5 000	Aerial photography, side scan sonar, underwater camera, diving	Miscellaneous	Bernard <i>et al.</i> (2003a)
La Ciotat, W Marseilles (Provence, France)	1/5 000	Aerial photography, side scan sonar, underwater camera, dredging, boating, diving	Miscellaneous	Bernard <i>et al.</i> (2003b)
Plateau des chèvres, Marseilles (Provence, France)	1/5 000	Aerial photography, diving	<i>Posidonia oceanica</i>	Pergent-Martini and Pergent (1990)
Côte Bleue (Provence, France)	1/5 000	Side scan sonar	<i>Posidonia oceanica</i>	Cristiani (1980)
Scandula nature reserve, Western Corsica	1/5 000	Boating	<i>Lithophyllum byssoides</i>	Bianconi <i>et al.</i> (1987)
Port-Cros Island (French Riviera, France)	1/4 762	Snorkelling	Miscellaneous	Augier and Boudouresque (1976)
Porto Colom, Mallorca (Balearic Islands, Spain)	1/4 000	Side scan sonar, Underwater camera	<i>Caulerpa taxifolia</i> , <i>C. prolifera</i>	Pérez-Blaya <i>et al.</i> (2000)
S Leghorn, Tuscany (Italy)	1/3 330	Diving	<i>Posidonia oceanica</i>	Piazzi <i>et al.</i> (1996)
Côte Bleue (Provence, France)	1/2 600	Aerial photography, side scan sonar	<i>Posidonia oceanica</i>	Niéri <i>et al.</i> (1991)
Banyuls-sur-Mer harbour, French Catalonia	1/2 310	Diving	<i>Posidonia oceanica</i> , <i>Zostera noltii</i>	Pergent <i>et al.</i> (1991)
San Fiorenzo gulf, Northern Corsica	1/2 000	Aerial photography, diving	<i>Posidonia oceanica</i>	Boudouresque <i>et al.</i> (1985b)
Villefranche (French Riviera, France)	1/1 333	Diving	<i>Posidonia oceanica</i>	Meinesz and Lefèvre (1984)
Port-Cros Island (French Riviera, France)	1/1 250	Aerial photography, snorkelling	Miscellaneous	Augier and Boudouresque (1967)

Elbu cove, Scandola nature reserve, Western Corsica	1/ 1190	Aerial photography, diving	Miscellaneous	Meinesz <i>et al.</i> (1988)
Bay of Menton (French Riviera, France)	1/1 150	Casi	<i>Posidonia oceanica</i> , <i>Caulerpa taxifolia</i>	Jaubert <i>et al.</i> (1999)
Port-Cros Island (French Riviera, France)	1/1 100	Diving	<i>Posidonia oceanica</i>	Bellone and Meinesz (1995)
Urla-Iskele, Gulf of Izmir (Turkey)	1/1 000	Diving	<i>Posidonia oceanica</i>	Pergent and Pergent (1985)
Port-Cros Island (French Riviera, France)	1/488	Aerial photography, snorkelling	Miscellaneous	Augier and Niéri (1988)
Port-Cros Island (French Riviera, France)	1/455	Diving	<i>Posidonia oceanica</i> , <i>Pinna nobilis</i>	Loquès <i>et al.</i> (1995)
Porquerolles Island (French Riviera)	1/320	Diving	Miscellaneous	Augier (1995)

THE MAPPED VEGETATION

Most maps of Mediterranean vegetation (Table 1) deal with *Posidonia oceanica* (Magnoliophyta, Embryobionta, Viridobionta, Plantae) meadows (e.g. Cristiani, 1980; Meinesz and Laurent, 1982; Augier *et al.*, 1984; Ramos Esplá, 1984; Meinesz *et al.*, 1987; Augier and Niéri, 1988; Hoareau, 1988; Bonhomme *et al.*, 2003), or communities and types of bottom adjacent to *P. oceanica* meadows, such as *Cymodocea nodosa*, *Zostera noltii* (Magnoliophyta, Plantae), sand and rocky substrates without indication of the actual community (e.g. Calvo and Fradà Orestano, 1984; Bianchi and Peirano, 1990; Fredj *et al.*, 1990; Pergent *et al.*, 1991; Cinelli *et al.*, 1992; Bianchi and Peirano, 1995; Piazzini *et al.*, 1996; Jaubert *et al.*, 1999; El Asmi-Djellouli *et al.*, 2000). With a few exceptions (e.g. Molinier and Picard, 1952; Augier and Boudouresque, 1970; Bernard *et al.*, 2003b; El Asmi-Djellouli *et al.*, 2000; El Asmi *et al.*, 2003; Riveill *et al.*, 2003), these maps do not distinguish the landscape types (= facies) that may occur within *P. oceanica* meadows, namely fringing reefs, barrier reefs, plain meadow, hill meadow, tiger meadow, escalator meadow, micro-atolls, waving meadow and sugar loaf meadow (Boudouresque *et al.*, 1985a, 1986, 2000).

In contrast, few maps deal with other macrophytes, such as *Rissoella verruculosa* and *Lithophyllum byssoides* (= *L. lichenoides*, Rhodobionta, Plantae) (Augier and Boudouresque, 1976; Bianconi *et al.*, 1987; Meinesz *et al.*, 2001; Bernard *et al.*, 2003b), *Cystoseira amentacea*, *C. brachycarpa* and *C. compressa* (Fucophyceae, Chromobionta, Stramenopiles) (Bellan-Santini, 1964; Augier and Boudouresque, 1967; Clarisse, 1984; Augier, 1995; Meinesz *et al.*, 1999, 2001; Soltan, 2001; Bernard *et al.*, 2003b), *Caulerpa prolifera*, *C. taxifolia* and *C. racemosa* (Chlorobionta, Viridobionta, Plantae) (Jaubert *et al.*, 1999; Belsher and Houlgatte, 2000; El Asmi-Djellouli *et al.*, 2000; Pérez-Blaya *et al.*, 2000; Meinesz *et al.*, 2003). Most of the above mentioned macrophytes are intertidal or shallow species. As far as deep water macrophytes other than Magnoliophyta are concerned, most maps concern *Caulerpa taxifolia* (Meinesz *et al.*, 2003).

As a result, there is an urgent need for maps of macrophytes other than seagrasses, such as *Cystoseira zosteroides*, *C. spinosa*, *C. brachycarpa*, sciaphilous Rhodobionta, barren ground (due to sea-urchin overgrazing) with incrusting corallines, etc. In addition, maps of *Posidonia oceanica* meadows should distinguish landscape types.

QUALITATIVE VERSUS QUANTITATIVE MAPS

Most of the available maps only deal with the presence or absence of a species (or a community): they are qualitative. A very few maps take into consideration an intermediate category, e.g. degraded *Posidonia oceanica* beds or high versus low covering or density (e.g. Fredj *et al.*, 1990; Cinelli *et al.*, 1992; Paillard *et al.*, 1993; Pasqualini, 1997; Bonhomme *et al.*, 2003). As far as shoot density of *P. oceanica* is concerned, it has been mapped via kriging (e.g. Francour and Marchadour, 1989). Bonhomme *et al.* (2003) did not map the actual shoot density, which decreases naturally with depth (so that it does not constitute a pertinent estimate of the seagrass health), but considered (i) values equal to or above the normal density at a given depth (according to Pergent *et al.*, 1995; Pergent-Martini *et al.*, 1999) and (ii) values below that normal density. In addition, information on the seagrass dynamics (regression or expansion) was superimposed on the map.

For the mapping of *Caulerpa taxifolia*, three levels of colonization (covering) are distinguished: covered area, affected area and concerned area (Meinesz *et al.*, 2001, 2003). For the mapping of *Lithophyllum byssoides*, isolated individuals versus a rim, and the width of the rim, were distinguished (Bianconi *et al.*, 1987; Bernard *et al.*, 2003b). For the mapping of the *Cystoseira amentacea* belt in the subtidal fringe, Ballesteros (*in* Soltan, 2001) utilizes 5 categories, from 1 (isolated individuals) to 5 (dense and continuous stand). Finally, for *Cystoseira brachycarpa*, the 6-level Braun-Blanquet scale (Boudouresque, 1971) was used (Clarisse, 1984).

In order to achieve some of the purposes of the cartography, namely the management of coastal areas and the monitoring of change over time, the changeover from qualitative to quantitative maps would be particularly welcome.

CAN WE TRUST EARLY MAPS?

In many regions, no or very few ancient maps are available. As a result, it is difficult or impossible to assess the dynamics of the vegetation. In an area near Marseilles (Provence, France) where there is a series of maps of the seagrass *Posidonia oceanica* beds spanning more than one century (dating from 1883, 1897, 1958, 1975, 1979, 1991, 2000 and 2003, respectively from Marion, 1883; Pruvot, 1897; Picard, 1965; Blanc, 1975; Cristiani, 1980; Niéri *et al.*, 1991; Bernard *et al.*, 2000; Bonhomme *et al.*, 2003), the last one very accurate (aerial photographs, side scan sonar and validation by ground truth), Leriche *et al.* (2004) pointed out dramatic differences between these maps (Fig. 1). In contrast with some other benthic communities, specific biological

features of *P. oceanica* made it possible to definitely rule out the possibility that the differences between most of these maps may have been due to actual changes in the seagrass meadow expanse. For example, the horizontal growth of a plagiotropic (= creeping) rhizome never exceeds 10 cm/a, and averages over long periods 4 cm/a (Boudouresque *et al.*, 1984; Meinesz and Lefèvre, 1984). Therefore a progression of more than 1 km in an offshore direction (between Marion's 1883 and Pruvot's 1897 map), then of nearly 1 km in the direction of the shore (between the Pruvot and Picard 1958 maps) is hardly credible (Fig. 1). Even the 1979 Cristiani map is dubious in some places (e.g. in the north-east part of the cove).

In order to assess the value of the ancient maps, attempts have been made to estimate the reliability of maps (Lehlé *et al.*, 1995; Pasqualini, 1997; Pergent-Martini, 2000; Leriche-Guichard, 2001; Bon-homme *et al.*, 2003). Leriche *et al.* (2004) have proposed a Reliability Index (RI), rated 1 to 50, which weights three parameters, within 3 depth ranges (0-5, 5-15 and >15 m): (i) the initial scale of the map (source map) and the working scale (target scale); (ii) the method(s) of data acquisition (e.g. dredging, grabs, aerial photographs, side scan sonar, scuba diving); and (iii) the method of geographical positioning of the data.

Leriche *et al.*, (2004) stated that the RI value of <25 is the critical level for total rejection of the maps (or part of maps). Unfortunately, most ancient and even relatively recent maps fall below this level. This is a deeply disappointing finding. Maps rated between 25 and 40 can be consulted with caution, depending on the purpose for which they are to be used. Finally, only maps (or parts of maps) rated over 40 can be taken fully into consideration.

Fig.1. Maps of the seagrass *Posidonia oceanica* in an area west of Marseilles (Provence, France) by Marion (1883), Pruvot (1897), Picard (1958, map from 1958), Blanc (1975), Cristiani (1980: map from 1979), Niéri *et al.* (1991), Bernard *et al.* (2000) and Bonhomme *et al.* (2003: present map). Arrows i to ix indicate conspicuous differences between maps from 1979 up to the present. From Leriche *et al.* (2004).

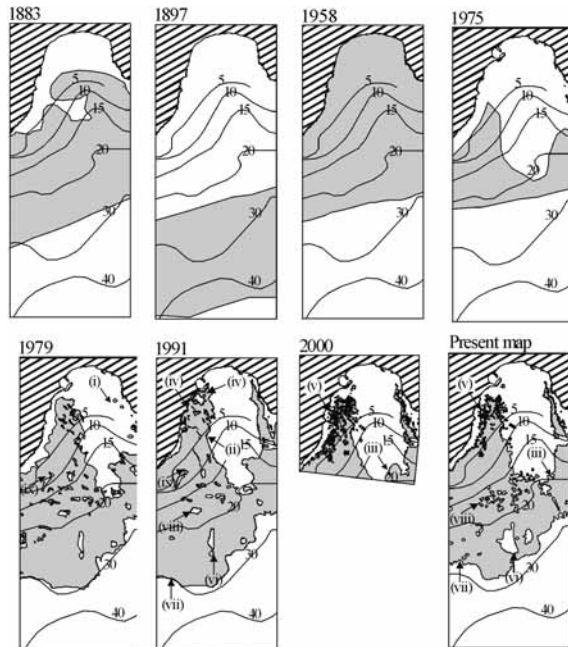

Despite the fact that hundreds of maps of the Mediterranean benthic vegetation are available, it is doubtful whether many of them fulfil any of the possible purposes of cartography: acquisition of scientific knowledge, coastal management taking into consideration nature conservation, long term dynamics and short term monitoring. Major criticisms are that they lack accuracy and that they are only qualitative (i.e. presence or absence of a species, a community, a landscape or a type of bottom).

Nevertheless, provided that the methods and degree of accuracy suit the use to which the maps are to be put (a rare feature: many maps were established without anticipating any specific use), cartography can be a valuable tool. Clearly, marine ecology, coastal management, nature conservation and environmental monitoring do require maps.

In addition, with the exception of the seagrass *Posidonia oceanica* (Magnoliophyta, Viridobionta, Plantae), maps of communities dominated by other macrophytes, e.g. *Cystoseira* spp., *Sargassum* spp., *Laminaria ochroleuca*, *Stypopodium shimperi* (Chromobionta, Stramenopiles), *Halopityis incurvus*, *Digenea simplex*, *Corallina elongata*, *Peyssonnelia* spp., encrusting corallines (Rhodobionta, Plantae) and *Caulerpa prolifera* (Chlorobionta, Viridobionta, Plantae) are too scarce.

REFERENCES

- Augier H. (1995) - Etude et cartographie des peuplements benthiques de l'île de Porquerolles (Méditerranée, France). III.- Transect permanent et cartographie biocénétique des Gorges du Loup, île de Porquerolles (Var, S.E., France). Sci. Rep. Port-Cros nation. Park, 16: 115-122.
- Augier H., Boudouresque C.F. (1967) - Végétation marine de Port-Cros (Parc national). I. La baie de La Palu. Bull. Mus. Hist. nat. Marseille, 27: 93-124 + pl.
- Augier H., Boudouresque C.F. (1970) - Végétation marine de Port-Cros (Parc national). V. La baie de Port-Man et le problème de la régression de l'herbier de posidonies. Bull. Mus. Hist. nat. Marseille, 30: 145-164 + pl.
- Augier H., Boudouresque C.F. (1976) - Végétation marine de Port-Cros (Parc national). XIII. Documents pour la carte des peuplements benthiques. Trav. sci. Parc nation. Port-Cros, 2: 9-22 + pl.
- Augier H., Niéri M. (1988) - Cartographie, balisage et dynamique du récif-barrière à *Posidonia oceanica* de la baie de Port-Cros (Parc national). Sci. Rep. Port-Cros nation. Park, 14: 29-40 + pl.
- Augier H., Niéri M., Gilli A., Martinet P., Stéphan G., Ventron G. (1984) - Balisage et cartographie de l'herbier de posidonies au large des plages artificielles de la baie de La Ciotat (BDR, France). In: International Workshop on *Posidonia oceanica* beds, Boudouresque C.F., Jeudy de Grissac A., Olivier J. (eds.), GIS Posidonie publ., Marseille, 1: 79-85.
- Bellan-Santini D. (1964) - Influence de la pollution sur quelques peuplements superficiels de substrat rocheux. In: Symp. Pollut. Mar. Microorgan. Prod. pétrol. CIESM publ., Monaco: 127-131.
- Bellone E., Meinesz A. (1995) - Cartographie sous-marine du Parc national de Port-Cros (Var, France). I - Élément de cartographie de l'herbier de *Posidonia oceanica* de la baie de Port-Man. Sci. Rep. Port-Cros nation. Park, 16: 123-128.

- Belsher T., Houlgatte E. (2000) - Etude des sédiments superficiels marins, des herbiers à phanérogames et des peuplements à *Caulerpa taxifolia* de Menton au Cap d'Ail. Ifremer publ., Brest: 44 pp + 3 maps.
- Belsher T., Loubersac L., Belbeoch G. (1985) - Remote sensing and mapping. In: Handbook of phycological methods. Ecological field methods: macroalgae, Littler M., Littler D.S. (eds), University Press publ., Cambridge: 177-197.
- Belsher T., Meinesz A., Lefèvre, J.R., Boudouresque, C.F. (1988) - Simulation of SPOT satellite imagery for charting shallow-water benthic communities in the Mediterranean. P.S.Z.N. Marine Ecology, 9: 157-165.
- Bernard G., Bonhomme P., Ruitton, S., Escoffier, B., Cadiou, G. (2000) - Caractérisation de l'herbier à *Posidonia oceanica* supérieur dans l'anse du rouet (commune de Carry-le-Rouet, Bouches-du-Rhône). SOGREAH and GIS Posidonie publ., Marseille : 28 pp.
- Bernard G., Denis J., Bonhomme P., Emery E., Cadiou G., Charbonnel E., Hervé G., Boudouresque C.F. (2003a) - Cartographie des biocénoses marines entre la Tour Fondue et l'île de Porquerolles. Alimentation en eau potable de l'île de Porquerolles. Rapport de synthèse final. Ville de Hyères-les-Palmiers, GIS Posidonie and Ifremer, GIS Posidonie publ., Marseille : 60 pp.
- Bernard G., Denis J., Cadiou G., Bonhomme P., Clabaut P., Ganteaume A., Andral B., Emery E. (2003b) - Etude du patrimoine marin environnant les domaines départementaux de l'île Verte et du Mugel. Phase II, Diagnostic. Contrat Conseil Général 13, GIS Posidonie and Ifremer, GIS Posidonie publ., Marseille.
- Bianchi C.N., Peirano A. (1990) - Mappatura delle praterie di *Posidonia oceanica* in Mar Ligure. ENEA publ, Santa Teresa, Italy: 372 pp + 12 pl.
- Bianchi C.N., Peirano A. (1995) - Atlante delle Fanerogame marine della Liguria. ENEA publ, La Spezia: 146 pp.
- Bianconi C.H., Boudouresque C.F., Meinesz A., Di Santo F. (1987) - Cartographie de la répartition de *Lithophyllum lichenoides* (Rhodophyta) dans la réserve naturelle de Scandola (côte orientale de Corse, Méditerranée). Trav. sci. Parc nat. rég. Réserves nat. Corse, 13: 39-63.
- Blanc J.J. (1975) - Recherches de sédimentologie appliquée au littoral rocheux de la Provence, aménagement et protection. Centre national pour l'exploitation des océans publ, Paris: 163 pp.
- Bonhomme P., Bernard G., Charbonnel E., Cadiou G., Leriche A., Angles d'Ortoli N., Le Diréac'h L., Denis J., Deneux F., Hervé G., Emery E., Clabaut P. (2003) - Guide méthodologique pour la cartographie des biocénoses marines. Volet n°1: l'herbier à *Posidonia oceanica*. Notice technique. Ifremer and Gis Posidonie publ, Marseille: 86 pp.
- Boudouresque C.F. (1971) - Contribution à l'étude phytosociologique des peuplements algaux des côtes varoises. Vegetation, 22: 83-184.
- Boudouresque C.F., Ballesteros E., Ben Maïz N., Boisset F., Bouladier E., Cinelli F., Cirik S., Cormaci M., Jeudy de Grissac A., Laborel J., Lanfranco E., Lundberg B., Mayhoub H., Meinesz A., Panayotidis P., Semroud R., Sinnassamy J.M., Span A., Vuignier G. (1990) - Livre rouge "Gérard Vuignier" des végétaux, peuplements et paysages marins menacés de Méditerranée. UNEP/IUCN/Gis Posidonie. UNEP MAP technical Series, 43: 1-250.
- Boudouresque C.F., Charbonnel E., Meinesz A., Pergent G., Pergent-Martini C., Cadiou G., Bertrand M.C., Foret P., Ragazzi M., Rico-Raimondino V. (2000) - A monitoring net-work based on the seagrass *Posidonia oceanica* in the north-western Mediterranean Sea. Biol. mar. Medit., 7 (2): 328-331.
- Boudouresque C.F., Jeudy de Grissac A., Meinesz A. (1984) - Relations entre la sédimentation et l'allongement des rhizomes orthotropes de *Posidonia oceanica* dans la baie d'Elbu (Corse). In: International workshop on *Posidonia oceanica* beds, Boudouresque C.F., Jeudy de Grissac A., Ollivier J. (eds.), GIS Posidonie publ, Marseille, 1: 185-191.

- Boudouresque C.F., Jeudy de Grissac A., Meinesz A. (1985a) - Un nouveau type d'herbier à *Posidonia oceanica* : l'herbier de colline. Rapp. P.V. Réun. Commiss. internation. Explor. sci. Médit., 29 (5): 173-175.
- Boudouresque C.F., Jeudy de Grissac A., Meinesz A. (1986) - Chronologie de l'édification d'une colline de Posidonies. Trav. sci. Parc nat. rég. Rés. Nat. Corse, 2: 3-12.
- Boudouresque C.F., Meinesz A., Lefèvre J.R. (1985b) - Cartographie des peuplements benthiques marins de Corse: I. La formation récifale à *Posidonia oceanica* de Saint-Florent. Ann. Inst. océanogr., 61 (1): 27-38.
- Calvo S., Fradà Orestano C., (1984) - L'herbier à *Posidonia oceanica* des côtes siciliennes: les formations récifales du Stagnone. In: International Workshop on *Posidonia oceanica* beds, Boudouresque C.F., Jeudy de Grissac A., Olivier J. (eds.), GIS Posidonie publ., Marseille, 1: 29-37.
- Charbonnel E., Vaugelas J. De, Chiaverini D., Cottalorda J.M., Gravez V., Francour P., Abellard O., Remonnay L., Menager V., Boudouresque C.F. (1995) - Cartographie de l'herbier de Posidonie et autres types de fonds dans le secteur des îles d'Hyères (Var, France) pour le passage d'un câble Télécom à fibres optiques. Notice d'impact. France Télécom and GIS Posidonie, GIS Posidonie publ. : 124 pp.
- Cinelli F., Pardi G., Papi I., Benedetti Cecchi L., Proietti Zolla A., Padula F., Acunto S., Castellazzi M., Airolidi L., Abbiati M. (1992) - Mappatura delle praterie di *Posidonia oceanica* (L.) Delile intorno alle isole minori dell'Arcipelago toscano. Centro universitario di Biologia marina di Livorno publ.: 145 pp + 8 maps.
- Clarisse S. (1984) - Apport de différentes techniques cartographiques à la connaissance de l'autoécologie de *Cystoseira balearica* Sauvageau, macroalgue marine dominante dans la région de Calvi (Corse). Lejeunia, N.S., 113: 1-24 + 2 maps.
- Colantoni P., Galignani P., Fresi E., Cinelli F. (1982) - Patterns of *Posidonia oceanica* (L.) Delile beds around the Island of Ischia (Gulf of Naples) and in adjacent waters. P.S.Z.N. Marine Ecology, 3 (1): 53-74 + 2 maps.
- Cristiani G. (1980) - Biomasse et répartition de l'herbier de *Posidonia oceanica* de la Côte Bleue (B.d.Rh.) et pollution marine par les métaux lourds. Thèse de doctorat, University of Aix-Marseille III: 150 pp + ix + 1 map.
- Cuvellier M. (1976) - Surveillance en temps réel de l'évolution des herbiers : nouvelle méthode de recensement des herbiers par cartographie au sonar latéral. In: 3^e Journées Etudes Pollutions, CIEM publ., Monaco: 191-193.
- Denis J., Hervé G., Deneux F., Sauzade D., Bonhomme P., Bernard G., Boudouresque C.F., Leriche A., Charbonnel E., Le Diréac'h L. (2003) - Guide méthodologique pour la cartographie des biocénoses marines. Volet n°1: l'herbier à *Posidonia oceanica*. Guide méthodologique. Ifremer and Gis Posidonie publ, Marseille: 93 pp.
- El Asmi S., Rais C., Rhomdhane M.S., El Herry S. (2003) - Cartographie du récif-barrière de posidonies de la baie de Sidi Rais (côtes nord-orientales de la Tunisie). In: Second Mediterranean symposium on marine vegetation, Athens 12-13 December 2003, Abstracts, Regional Activity Center for Specially Protected Areas publ., Tunis: 13.
- El Asmi-Djellouli Z., Djellouli A.S., Abdeljaoued S. (2000) - Présentation des herbiers de la baie de Monastir (Tunisie). In: Proceedings of the first Mediterranean symposium on marine vegetation, Ajaccio 3-4 October 2000, Regional Activity Center for Specially Protected Areas publ., Tunis: 132-135.
- Francour P., Marchadour M. (1989) - Les fonds marins, et en particulier, l'herbier à *Posidonia oceanica* aux alentours du port de la Pointe Rouge (Marseille). GIS Posidonie publ., Marseille: 48 pp.
- Fredj G., Meinardi M., Pierrot S., Roy P. (1990) - Cartographie par le satellite Spot 1 de communautés benthiques littorales en Méditerranée occidentale. Bull. Inst. océanogr., spec. issue 6: 71-85.

Gloux B. (1984) - Méthodes acoustiques et informatiques appliquées à la cartographie rapide et détaillée des herbiers. In: International Workshop on *Posidonia oceanica* beds, Boudouresque C.F., Jeudy de Grissac A., Olivier J. (eds.), GIS Posidonie publ., Marseille, 1: 45-48.

Hoareau A. (1988) - Cartographie des végétaux marins par images SPOT. Presqu'île de Giens. Mémoire Dipl. Etudes supérieures spécialisées, Univ. Pierre et Marie Curie, Paris: 28 pp + 22 pl. + 23 unnumbered pp.

Iehlé A., Wald L., Boudouresque C.F. (1995) - Analyse et évaluation de la fiabilité de l'information dans le système d'information géographique des assemblages benthiques méditerranéens "MBA". Sci. Rep. Port-Cros nation. Park, 16: 99-113.

Jaubert J.M., Chisholm J.R.M., Ducrot D., Ripley H.T., Roy L., Passeron-Seitre G. (1999) - No deleterious alterations in *Posidonia* beds in the bay of Menton (France) eight years after *Caulerpa taxifolia* colonization. J. Phycol., 35: 1113-1119.

Leriche-Guichard A. (2001) - Mise en place d'un outil de surveillance de l'herbier à *Posidonia oceanica* (L.) Delile: le SIG Posidonie. Application à la Côte Bleue. Mémoire Dipl. Etudes approf. "Biosciences de l'environnement, chimie et santé", Université Aix-Marseille II: 45 pp.

Leriche A., Boudouresque C.F., Bernard G., Bonhomme P., Denis J. (*in press*) - A one-century suite of seagrass bed maps: can we trust ancient maps? Estuarine cost. Shelf Sci.

Loquès F., Bellone E., Meinesz A., Villette M. (1995) - Cartographie sous-marine du Parc national de Port-Cros (Var, France). II – La zone protégée de la baie de La Palud. Sci. Rep. Port-Cros nation. Park, 16: 129-133 + 1 map.

Marion, A.F. (1883) - Esquisse d'une topographie zoologique du Golfe de Marseille. Ann. Mus. Hist. nat. (Zoologie) Marseille, 1: 7-108 + map.

Meinesz A., Belsher T., Boudouresque C.F., Lefèvre J.R. (1991) - Première évaluation des potentialités du satellite SPOT pour la cartographie des peuplements benthiques superficiels de Méditerranée occidentale. Oceanologica Acta, 14: 199-207.

Meinesz A., Belsher T., Thibaut T., Antolic B., Ben Mustapha K., Boudouresque C.F., Chiaverini D., Cinelli F., Cottalorda J.M., Djellouli A., El Abed A., Orestano C., Grau A.M., Ivesa L., Jaklin A., Langar H., Massuti-Pacual E., Peirano A., Tunesi L., De Vaugelas J., Zavodnik N., Zuljevic A. (2001) - The introduced green alga *Caulerpa taxifolia* continues to spread in the Mediterranean. Biological Invasions, 3: 201-210.

Meinesz A., Boudouresque C.F., Bianconi C.H., Simonian M. (1987) - Cartographie de la limite inférieure de l'herbier de posidonies de la baie d'Elbo. Trav. sci. Parc nat. rég. Réserves nat. Corse, 13: 27-37 + pl.

Meinesz A., Boudouresque C.F., Falconetti C., Astier J.M., Bay D., Blanc J.J., Bourcier M., Cinelli F., Cirik S., Cristiani G., Di Geronimo I., Giaccone G., Harmelin J.G., Laubier L., Lovric A.Z., Molinier R., Soyler J., Vamvakas C. (1983) - Normalisation des symboles pour la représentation et la cartographie des biocénoses benthiques littorales de Méditerranée. Ann. Inst. océanogr., 59 (2): 155-172.

Meinesz A., Boudouresque C.F., Lefèvre J.R. (1988) - A map of the *Posidonia oceanica* beds of marina d'Elbu (Corsica, Mediterranean). P.S.Z.N Marine Ecology, 9: 243-252.

Meinesz A., Boudouresque C.F., Vaugelas J. de, Chiaverini D. (1998) - Carte des biocénoses sous-marines de la baie d'Elbo (réserve naturelle de Scandola). Trav. sci. Parc nat. rég. Réserves nat. Corse, 57: 163-169.

Meinesz A., Chiaverini D., Cottalorda J.M., Gilletta L., Javel F., Molenaar H. (2001) - Représentation cartographique de l'abondance de quelques algues et invertébrés du littoral de la face Sud du Parc national de Port-Cros. Laboratoire Environnement marin littoral, Nice University publ., 7 pp + 20 pl.

Meinesz A., Cuvelier M., Laurent R. (1981) - Méthodes récentes de cartographie et de surveillance des herbiers de phanérogames marines. Leurs applications sur les côtes françaises de la Méditerranée. Vie Milieu, 31: 27-34.

Meinesz A., Javel F., Cottalorda J.M., Garcia D. (2003) - Suivi de l'invasion des algues tropicales *Caulerpa taxifolia* et *Caulerpa racemosa* en Méditerranée. Situation devant les côtes françaises et monégasques au 31 décembre 2002. Laboratoire Environnement marin littoral, Nice University publ.: 115 pp.

Meinesz A., Laurent R. (1980) - Cartes de la limite inférieure de l'herbier à *Posidonia oceanica* dans les Alpes Maritimes (France). Campagne Poseidon 1976. Ann. Inst. océanogr., 56 (1): 45-54.

Meinesz A., Laurent R. (1982) - Cartes de la végétation sous-marine des Alpes Maritimes (côtes françaises de la Méditerranée). I.- Limite inférieure de l'herbier de *Posidonia oceanica* dans le Golfe Juan et à l'Est des îles de Lérins. Bull. Inst. Océanogr., 58 (1): 103-112.

Meinesz A., Lefèvre J.R. (1984) - Régénération d'un herbier à *Posidonia oceanica* quarante années après sa destruction par une bombe dans la rade de Villefranche (Alpes Maritimes). In: International Workshop on *Posidonia oceanica* beds, Boudouresque C.F., Jeudy de Grissac A., Olivier J. (eds.), GIS Posidonie publ., Marseille, 1: 39-44.

Meinesz A., Simonian M. (1983) - Cartes de la végétation sous-marine des Alpes Maritimes (côtes françaises de la Méditerranée). II. - la végétation mixte à *Cymodocea nodosa* - *Zostera noltii* - *Caulerpa prolifera* et la limite supérieure de l'herbier de *Posidonia oceanica* entre Juan-les-Pins et Golfe Juan. Bull. Inst. océanogr., 59 (1): 21-35.

Meinesz A., Vaugelas J. de, Chiaverini D., Bialecki K., Cottalorda J.M., Molenaar H. (1999) - Répartition cartographique de l'abondance de quelques algues et invertébrés du littoral de la réserve naturelle de Scandola (Corse). Laboratoire Environnement marin littoral, Nice University publ: 8 pp + 60 pl. + 1 table.

Molinier R., Picard J. (1952) - Recherches sur les herbiers de phanérogames marines du littoral méditerranéen français. Ann. Inst. océanogr., 27 (3): 157-234.

Niéri M., Francour P., Sinassamy J.M., Urscheller F., Fleury M.C. (1991) - Les fonds marins de l'anse du Rouet (Carry-le-Rouet, B.d.Rh.). Etude de site. GIS Posidonie publ., Marseille: 107 pp + 1 map.

Paillard M., Gravez V., Clabaut P., Walker P., Blanc J.J., Boudouresque C.F., Belsher T., Urscheler F., Poydenot F., Sinnassamy, J.M., Augris C., Peyronnet J.P., Kessler M., Augustin J.M., Le Drezen E., Prudhomme C., Raillard J.M., Pergent G., Hoareau A., Charbonnel E. (1993) - Cartographie de l'herbier de Posidonie et des fonds marins environnants de Toulon à Hyères (Var, France). Reconnaissance par sonar latéral et photographie aérienne. Notice de présentation. Ifremer and GIS Posidonie publ., Marseille : 36 pp + 3 maps.

Pasqualini V. (1997) - Caractérisation des peuplements et types de fonds le long du littoral corse (Méditerranée, France). Thèse Doctorat, Corsica University: 190 pp.

Pasqualini V., Clabaut P., Pergent G., Benyoussef L., Pergent-Martini C. (2000) - Contribution of side scan sonar to the management of Mediterranean littoral ecosystems. Intl. J. Remote Sensing, 21 (2): 367-378.

Pasqualini V., Pergent-Martini C. (1996) - Monitoring of *Posidonia oceanica* meadows using image processing. In: Seagrass biology: proceedings international workshop, Kuo, Phillips, Walker, Kirkman (eds.), Australia: 351-358.

Pasqualini V., Pergent-Martini C., Clabaut P., Pergent G. (1998) - Mapping of *Posidonia oceanica* using aerial photographs and side scan sonar: application off the Island of Corsica (France). Estuar. coast. Shelf Sci., 47: 359-367.

- Pasqualini, V., Pergent-Martini, C., Pergent, G. (1999) - Environmental impact identification along the Corsican coast (Mediterranean Sea) using image processing. *Aquatic Botany*, 65: 311-320.
- Pérez-Blaya E., González-Reyez M., Marhuenda-Irastorza M., Román-Eclapez F., Alemañ-Larrosa J.F. (2000) – Cartografía de *Caulerpa taxifolia* en Porto Colom (Mallorca). *Mediterraneo Servicios marinos and Govern Balear publ.*: 9 pp + 4 maps + 6 pp.
- Pergent G. (1990) - Utilisation de la technique du krigeage en cartographie benthique: intérêt et limites. *Rapp. P.V. Réunion. Commiss. Internation. Explor. sci. Médit.*, 32 (1), B18: 6.
- Pergent G., Boudouresque C.F., Thélin I., Marchadour M., Pergent-Martini C. (1991) - Map of benthic vegetation and sea-bottom types in the harbour at Banyuls-sur-Mer (P.O., France). *Vie Milieu*, 41 (2-3): 165-168.
- Pergent G., Pergent C. (1985) - Cartographie de l'herbier à *Posidonia oceanica* de la baie d'Urla-Iskele (Turquie). *Rapp. P.V. Réunion. Commiss. Internation. Explor. sci. Médit.*, 29 (6): 231-234.
- Pergent G., Pergent-Martini C., Boudouresque C.F. (1995) - Utilisation de l'herbier à *Posidonia oceanica* comme indicateur biologique de la qualité du milieu littoral en Méditerranée: état des connaissances. *Mésogée*, 54: 3-27.
- Pergent-Martini C. (2000) - Utilisation des herbiers de phanérogames marines dans la gestion du littoral méditerranéen. Diplôme d'habilitation à diriger des recherches, University of Corsica, Corte: 90 pp + appendices.
- Pergent-Martini C., Pergent G. (1990) - Suivi de l'évolution de l'herbier à *Posidonia oceanica* après la mise en service de la station d'épuration de Marseille. *GIS Posidonie publ.*, Marseille: 58 pp.
- Pergent-Martini C., Pergent G., Fernandez C., Ferrat L. (1999) - Value and use of *Posidonia oceanica* as a biological indicator. In: *Medcoast 99-EMECs 99 Joint conference*: 73-89.
- Piazzì L., Balestri E., Cinelli F. (1996) - Mappatura e monitoraggio di una prateria a *Posidonia oceanica* (L.) Delile situata a Sud di Livorno (Toscana, Italia). *G. bot. ital.*, 28 (1): 67-77.
- Picard J. (1965) - Recherches qualitatives sur les biocoenoses marines des substrats meubles dragables de la région marseillaise. Thèse de doctorat sciences naturelles, University of Aix-Marseille, 160 pp + 1 map.
- Pruvot G. (1897) - Essai sur les fonds et la faune de la Manche Occidentale (côtes de Bretagne) comparés à ceux du Golfe du Lion. *Arch. Zool. exp. gén.*, 3: 510-684.
- Ramos Esplá A.A. (1984) - Cartografía de la pradera superficial de *Posidonia oceanica* en la bahía de Alicante (SE, España). In: *International Workshop on Posidonia oceanica beds*, Boudouresque C.F., Jeudy de Grissac A., Olivier J. (eds.), *GIS Posidonie publ.*, Marseille, 1: 57-61.
- Riveill S., Djebo H., Hamrit R., El Abed A. (2003) - Caractérisation de faciès rares d'herbiers à Posidonies: les microatolls de la lagune d'El Biban. In: *Second Mediterranean symposium on marine vegetation, Athens 12-13 December 2003, Abstracts*, Regional Activity Center for Specially Protected Areas publ., Tunis: 34.
- Soltan D. (2001) - Etude de l'incidence de rejets urbains sur les peuplements superficiels de macroalgues de Méditerranée. Thèse Doctorat, University of the Mediterranean, Marseille: 157 pp.

ANTHROPOGENIC IMPACTS ON MARINE VEGETATION IN THE MEDITERRANEAN

Charles F. BOUDOURESQUE, Sandrine RUITTON and Marc VERLAQUE

Centre d'Océanologie de Marseille, UMR 6540, Campus of Luminy, 13288 Marseilles cedex 9, France

ABSTRACT

The notion of plant kingdom, commonly accepted since the time of Linnaeus (18th century) actually encompasses a highly polyphyletic set of taxa belonging to Procaryota and Eucaryota and, within the Eucaryota, to six out of the eight kingdoms, namely Opisthokonts, Amaeobionta, Plantae, Stramenopiles, Alveolobionta and Discicristobionta. Therefore, for at least two decades, plants (and vegetation) have no longer been scientific concepts but a matter of customary usage. Biodiversity means the variety among living organisms including, inter alia, diversity within species, between species, ecosystems and landscapes and functional diversity. As far as species diversity is concerned, point diversity, alpha diversity, beta diversity, gamma diversity and epsilon diversity should be considered separately, since anthropogenic impact can increase alpha diversity while reducing gamma diversity. The Mediterranean Sea may be considered as a hot spot of marine epsilon species diversity. The ranking of the relative importance of human impact on biodiversity must take into account the time necessary for the impact to become reversible: from a few days to millennia. Thus, coastal development, species introduction, species extinction and global warming are of major concern. (i) Coastal development especially concerns shallow and highly productive bottoms with seagrass and other macrophyte communities. In the Mediterranean, both tourism (a third of total world tourism) and the population explosion are boosting coastal development. (ii) The Mediterranean Sea constitutes a hot spot for species introduction: introduced species nowadays represent 6,5% of its flora, and their number is doubling every twenty years. (iii) No "plant" species are known to have become extinct due to human impact, but many species and communities are vulnerable, i.e. have experienced a dramatic decline over the last decades (e.g. *Lithophyllum byssoides* rims, *Posidonia oceanica* meadows and *Cystoseira* forest) (iv) Finally, global warming (partly due to natural climatic shift) can upset the existing equilibrium.

INTRODUCTION

Human impact on biological diversity in the Mediterranean, in particular on the benthic vegetation, is generally thought to be high, due to tourism (the Mediterranean region accounts for a third of the total number of tourists worldwide), population explosion and the subsequent coastal development.

Here, we will firstly delineate what encompasses the popular notion of plant. Then we will define biodiversity, especially alpha and gamma species diversity, since some forms of impact may increase alpha diversity while reducing gamma diversity. We will rank human impacts according to the time necessary for the impact to become reversible. Clearly, those forms of impact which are irreversible at human scale (e.g. coastal development, species introduction, species extinction and global warming) are a much greater cause for concern than those which are reversible within a few years (e.g. most types of pollution and oil spills). Here, we will only address three forms of human irreversible impact: coastal development, introduced species and global warming. Finally, we will leave aside the well known decline of the *Posidonia oceanica* seagrass and poorly documented problems such as the decline of epiflora of the coastal detritic community, to focus on two case studies, *Cystoseira* forests and *Lithophyllum byssoides* rims.

THE NOTION OF VEGETATION

The notion of plant kingdom versus animal kingdom dates back to Karl von Linnaeus, two and a half centuries ago. He empirically gathered within his plant kingdom flowering plants (Phanerogama, now Magnoliophyta) and Cryptogama (ferns, mosses, fungi and algae). Scientific findings in the fields of anatomy, cytology, biochemistry, biology and finally molecular biology invalidated this classification between the end of the 19th century and the 1980s. Surprisingly, this customary classification is still in use in many text books and is still taught in most universities in Mediterranean countries.

Teachers either actually ignore a one century suite of discoveries, or are aware that some changes happened but claim that "*new classification is too complicated and therefore cannot be understood by students*" (by students? or by themselves?) and that "*it is changing over time, so that it is preferable to wait until it is would be stabilized before teaching it*". The latter argument is of course irrelevant. Firstly, the main features of the modern classification have been more or less stabilized for at least two decades. Secondly, changing likely hypotheses into more likely hypotheses constitutes a general characteristic of Science: stabilization will never occur. Do geneticists wait decades to teach new notions on the plea that they will continue to be improved over time?

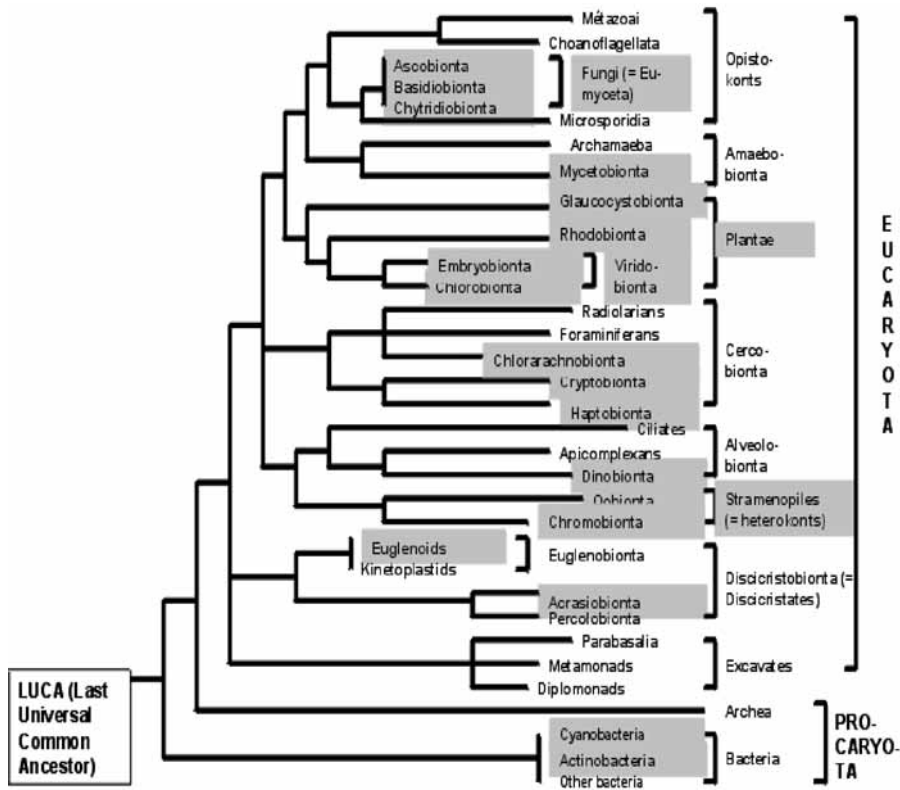

Fig.1. The tree of life: taxa belonging to the customary notion of plants are shaded in grey. Length of the branches is only due to graphical constraints, and therefore does not present here any phylogenetic meaning. From Baldauf (2003) and Pennisi (2003), modified and simplified.

The so-called plant kingdom encompasses at the present time (Fig. 1, 2) Procaryota (namely Cyanobacteria and Actinobacteria) and taxa belonging to 6 out of the 8 Eucaryota kingdoms:

Fungi (kingdom Opisthokonts), Mycetobionta (kingdom Amoebo-bionta), Viridobionta (green plants) and Rhodobionta (red algae) (kingdom Plantae), Chlorarachnobionta, Haptobionta and Cryptobionta (kingdom Cercobionta), Dinobionta (kingdom Alveolobionta), Chromobionta and Oobionta (kingdom Stramenopiles = Heterokonts), and finally Euglenoids and Acrasiobionta (kingdom Discicristobionta = Discicristates). This suite is highly polyphyletic (e.g. Kumar and Rzhetsky, 1996; Baldauf, 2003; Pennisi, 2003).

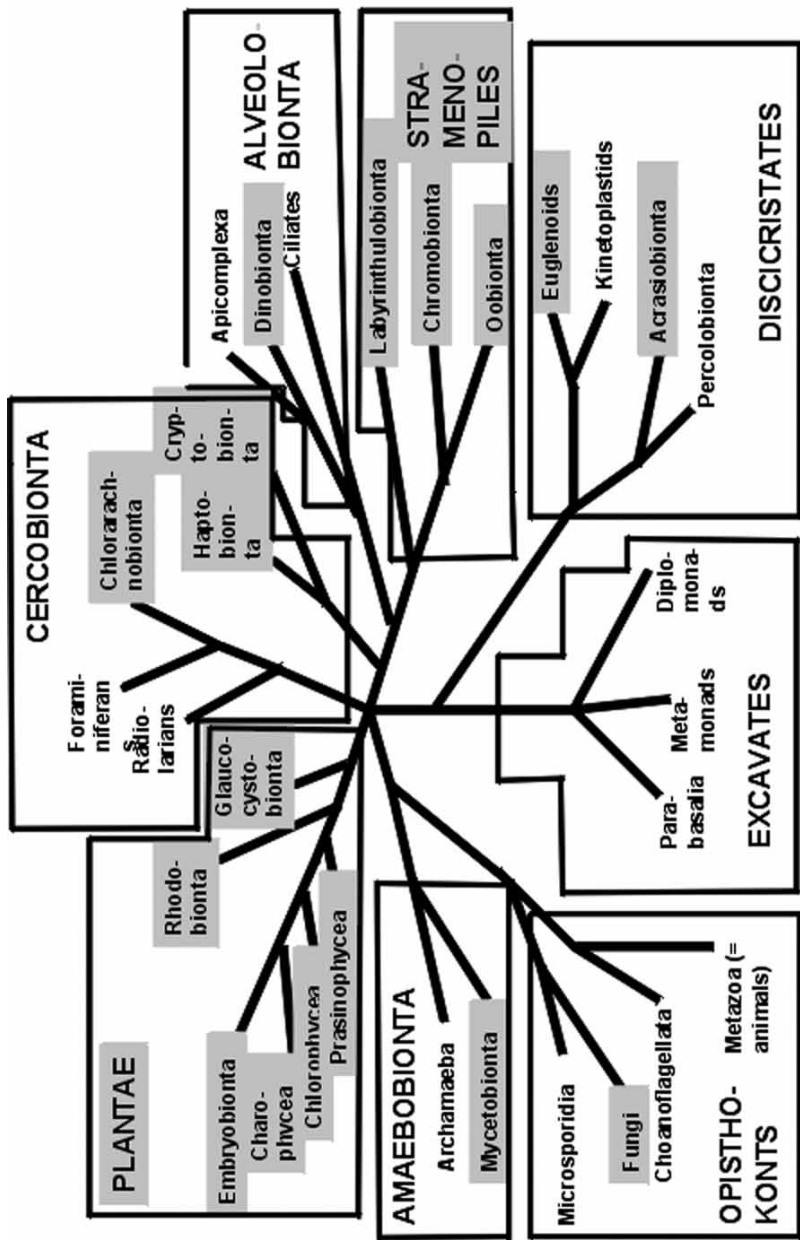

Fig. 2. The tree of Eucaryota: taxa belonging to the customary notion of plants are shaded in grey. From Baldauf (2003), modified and simplified.

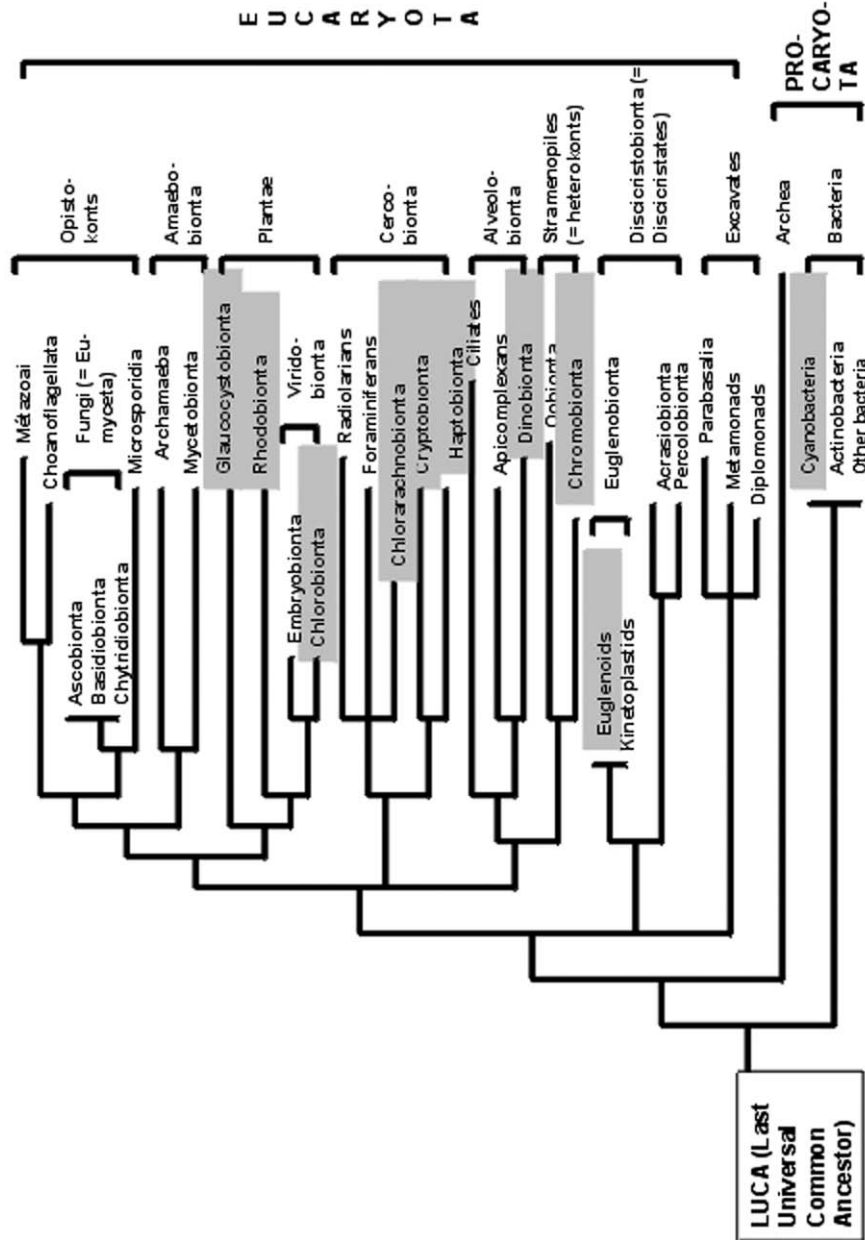

Fig. 3. The tree of life: taxa belonging to the customary notion of algae are shaded in grey. Length of the branches is only due to graphical constraints, and therefore does not present here any phylogenetic meaning. From Baldauf (2003) and Pennisi (2003), modified and simplified.

In the same way, "algae" (Fig. 3) and "fungi *sensu lato*" (Fig. 4) are polyphyletic sets of taxa. Algae (Fig. 3) belong to the Procaryota (Cyanobacteria) and to 5 Eucaryota kingdoms (namely Plantae, Cercobionta, Alveolobionta, Stramenopiles and Discicristates). "Macroalgae" (i.e. pluricellular algae) belong to two kingdoms: Plantae and Stramenopiles. It is worth empha-sizing that there is a greater distance (i.e. the common ancestor is more ancient) between a so-called "brown alga" (Fucophyceae, Chromobionta, Stramenopiles) and a "green alga" (Chlorobionta, Viridobionta, Plantae) than between a green alga and a flowering plant (Magnoliophyta, Embryobionta, Viridobionta, Plantae) or between green algae and Metazoa (Opisthokonts) (Lecointre and Leguyader, 2001). Fungi *sensu lato* belong to Procaryota (Actinobacteria) and to 4 Eucaryota kingdoms (Fig. 4).

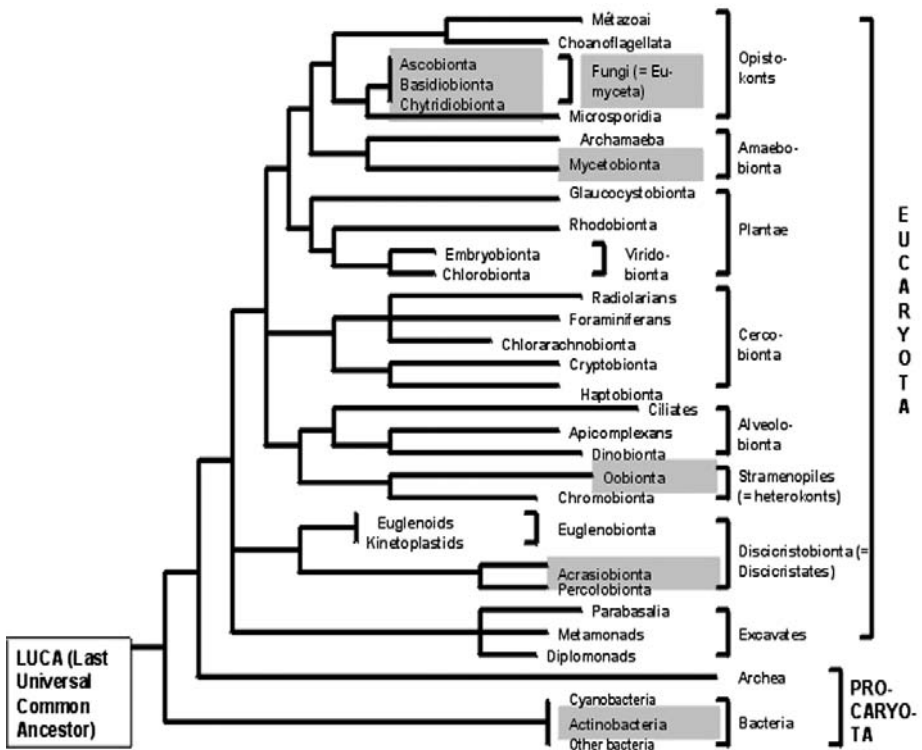

Fig. 4. The tree of life: taxa belonging to the customary notion of Fungi (*sensu lato*) are shaded in grey. Length of the branches is only due to graphical constraints, and therefore does not present here any phylogenetic meaning. From Baldauf (2003) and Pennisi (2003), modified and simplified.

BIODIVERSITY

Biological diversity (biodiversity) means the variety among living organisms from all sources including, *inter alia*, terrestrial, marine and other aquatic ecosystems and the complexes of which they are part. This includes diversity within species, diversity between species, between ecosystems, between landscapes and functional diversity (Ramade, 1994). Ecosystem diversity is often referred to as "ecodiversity".

As far as species diversity is concerned, point species diversity refers to the number of species within a sample, alpha species diversity to the number of species within a given habitat (e.g. the *Posidonia oceanica* meadow) in a given region (e.g. Liguria), beta species diversity the species turnover between adjacent habitats of a given region, gamma species diversity to the number of species within all habitats of a given region, and epsilon species diversity the number of species within a biogeographical province (e.g. the Mediterranean Sea) (Wilson and Shmida, 1984; Gray, 2000, 2001).

Human impact may increase alpha diversity of low species diversity habitats or even of some taxonomical groups in habitats with high species diversity (e.g. Dimech *et al.*, 2002), while gamma diversity decreases. This is the reason why some naïve authors emphasize that pollution (e.g. aquaculture farms) and introduced species (e.g. *Caulerpa taxifolia*) constitute valuable diversity enhancers (Fig. 5).

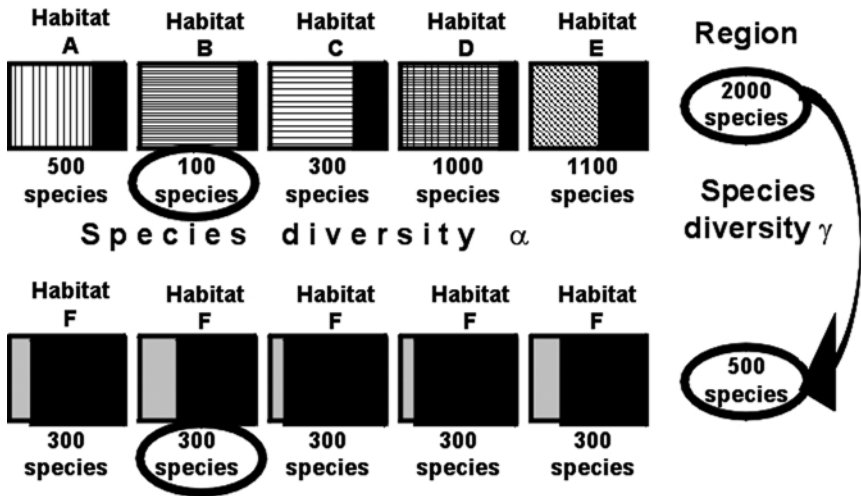

Fig. 5. Above: an example of alpha species diversity within 5 benthic habitats (A through E) in a given region. Gamma species diversity is not the sum of the 5 alpha diversities, since some species are common to the five habitats (in black). Below: human impact (e.g. pollution or the introduced species *Caulerpa taxifolia*) has more or less homogenized the communities (habitat F). The disturbance may increase (e.g. B, a sand bottom habitat) or decrease (e.g. E, a rocky bottom habitat) alpha species diversity. However, as far as gamma species diversity is concerned (right), it dramatically decreases.

While the Mediterranean Sea only represents less than 0.8% of the total area of the world's oceans and less than 0.3% of their volume, its macrophyte (i.e., hereafter, pluricellular Plantae, Chromobionta and Cyanobacteria) epsilon species diversity represents 12% of the world's described species, with conspicuous differences according to the considered taxa (e.g. 17% for Fucoephyceae, Chromobionta) (Ribera *et al.*, 1992; Boudouresque, 1997).

It does not appear to be the case that what we see is an artefact linked to the intensity of scientific investigation being greater than for other regions of the world (Fig. 6): larger seas, with greater intensity of scientific investigation than in the eastern Mediterranean (e.g. the Gulf of Mexico, the south-eastern coast of USA and the Caribbean Sea) show a much lower epsilon species diversity (Fig. 6; Boudouresque, 1997).

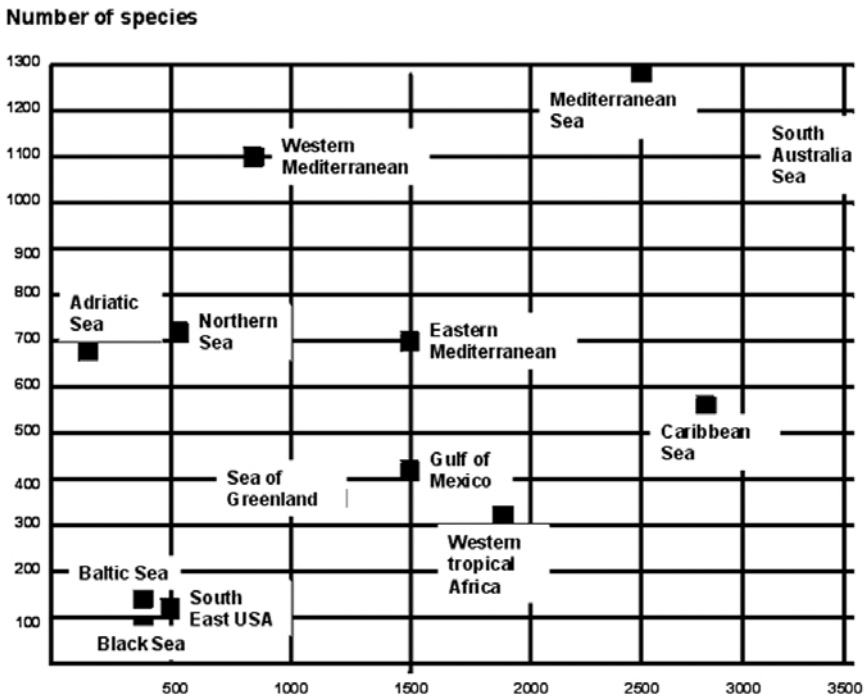

Fig. 6. Epsilon species diversity of macrophytes (i.e. pluricellular Plantae, Chromobionta and Cyanobacteria): number of species versus surface area (x 1000 km²) of the biogeographic regions. From Boudouresque (1997).

Therefore, the Mediterranean Sea may be considered as a hot spot of marine macrophyte species diversity. One of the reasons for its richness is the coexistence, in the Mediterranean, of species from the warm and boreal Atlantic, the tropical Atlantic and the Indo-Pacific Ocean. Another reason is the high rate of endemism.

RANKING HUMAN IMPACT

Human impact can be ranked according to the time necessary for the impact to become reversible after the disturbance occurred (e.g. an oil spill) or after the suspension of the stress (e.g. the setting up of a wastewater treatment plant) (Table I).

Domestic pollution effects on soft bottom assemblages become barely discernible after less than a decade (Bellan *et al.*, 1999). In a station impacted by hydrocarbons from the Amoco Cadiz wreck (English Channel, France), recolonization by the benthic Amphipoda *Ampelisca* was achieved after 12 years; recolonization was retarded due to the combination of the demographic strategy of *Ampelisca* (e.g. absence of pelagic larvae and low fecundity) and the distance from non-impacted population which could supply recruits (Poggiale and Dauvin, 2001). As far as other taxa are concerned, the impact of oil spills is often weak and only lasts a few years (Marchand, 1981; Raffin *et al.*, 1991; but see Peterson *et al.*, 2003). In some cases, the impact of cleaning processes (e.g. scrubbing the rocks with brushes and high pressure water jets; fortunately, surfactant is no longer used) is greater than that of the oil spill itself (e.g. Clark, 1986; Cognetti and Cognetti, 1992).

Table 1. Ranking of the relative importance of human impact, according to the time necessary for the impact to become reversible.

Rank	Time necessary for reversibility	Some examples
1	1 day through 1 month	Some local pollution events
2	1 month through 1 year	Some local pollution events
3	1 year through 10 years	Overfishing (cascade effect), some pollution events, oil spills
4	10 years through 1 century	Long-lived species destruction (e.g. <i>Cystoseira spp.</i>)
5	1 century through 1 millennium	Long-lived species destruction (e.g. <i>Posidonia oceanica</i>), overfishing (genetic shift)
6	More than 1 millennium	Coastal development, species introduction, species extinction, global warming

In contrast, long lasting and irreversible impact (e.g. long-lived species destruction, coastal development, introduced species) are greater cause for concern. Unfortunately, the public, and therefore journalists and decision makers, give priority to spectacular events, or accidents, as opposed to what is lasting, what is chronic, even though the consequences of chronic impact are often more serious than those of a one-off event.

COASTAL DEVELOPMENT

The destruction of benthic communities by coastal development (e.g. reclamation, harbours, and artificial beaches) is one of the most serious forms of human impact in the Mediterranean Sea, due to its irreversibility, at least at human scale. This destruction especially concerns shallow and highly productive bottoms (Table 2; Meinesz *et al.*, 1981, 1982, 1991), such as seagrass meadows (*Posidonia oceanica*, *Cymodocea nodosa*), littoral belts of *Cystoseira amentacea* and *Lithophyllum byssoides* (= *L. lichenoides*) and deeper *Cystoseira* forests. Many of the species involved are threatened species which are protected either by national legislation or by the Bern and Barcelona conventions.

In the Mediterranean, both tourism (one third of the total world tourism) and population explosion are boosting coastal development (Allué-Puyelo and Olivella-Prats, 1994; Charpentier *et al.*, 1995). In addition to its direct impact, coastal development can lead to indirect effects which may concern a much larger surface area than that actually covered by reclamation and facilities (Astier *et al.*, 1980; Astier, 1984; Gravez *et al.*, 1992). For example, groynes alter sediment transport by coastal currents, with either upstream oversedimentation that buries *Posidonia oceanica* leaf shoots or downstream undersedimentation (resulting in bare rhizomes): in both cases, the *P. oceanica* meadow may fall into decay (Boudouresque and Meinesz, 1982; Boudouresque and Jedy de Grissac, 1983). The construction of the Pointe-Rouge harbour (Marseilles, France) resulted in the direct destruction of 11 ha of *P. oceanica* meadow (covering) and in the indirect destruction of 68 more hectares (silting and water turbidity during the construction works) (Gravez *et al.*, 1992).

Table 2. Percentage of surface area of subtidal seabeds and of coastline undergoing (and irreversibly destroyed by) coastal development in the Provence and French Riviera region (France).
From Meinesz *et al.* (1981, 1982, 1991).

Departments	0-10 m seabed	0-20 m seabed	Coastline
East Bouches-du-Rhône	27%	19%	21%
Var	11%	7%	12%
Alpes-Maritimes and Monaco	20%	12%	24%
The region as a whole	15%	10%	16%

INTRODUCED SPECIES

An introduced species is a species the extension of whose range is linked, directly or indirectly, to human activity. There is a geographical discontinuity between its native area and its new area (remote dispersal). Finally, populations of individuals are born *in situ*, without human assistance: the species is naturalized. As a result, species such as *Geranium*, corn and potatoes are not introduced species in Europe (Boudouresque and Ribera, 1994; Ribera, 1994; Ribera and Boudouresque, 1995; Boudouresque, 1999a).

In the same way, *Caulerpa prolifera* (Chlorobionta, Viridobionta, Plantae), which moves northwards from the central and southern Mediterranean during warm climatic episodes, then southwards during cold episodes, is not an introduced species in the north-western Mediterranean (e.g. the Gulf of Marseilles), where it occurs nowadays (Marc Verlaque, unpublished data).

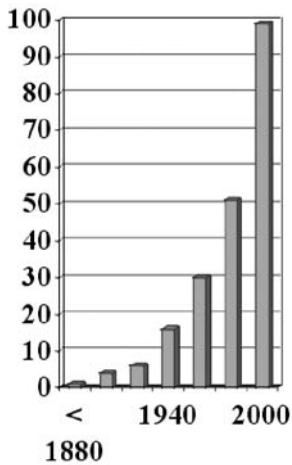

Fig. 7. Change over time (every 20 years, 1880 through 2000) in the cumulative number of likely introduced macrophytes in the Mediterranean Sea. From Boudouresque (1999a) and Boudouresque and Verlaque (2002), up-dated.

Since the early 20th century, the number of species probably introduced into the Mediterranean has more or less doubled every 20 years (Fig. 7; Boudouresque, 1999a; Boudouresque and Verlaque, 2002). To date, a hundred of macrophytes have probably been introduced into the Mediterranean. They represent 6.5% of its known flora. For comparative purposes, there are only 37 along the European and northern Africa Atlantic coasts (from Canary Islands to Scandinavia and the Baltic Sea). The Mediterranean Sea is therefore a major hot spot for introduced species.

The main vectors of introduction are shellfish aquaculture, fouling on ship hulls and the Suez Canal (Boudouresque, 1999a, 1999b; Boudouresque and Verlaque, 2002). After habitat destruction, introduced species are the second greatest cause of species endangerment and decline worldwide (Schmitz and Simberloff, 1997). However, each introduced species constitutes a special case (Carlton and Geller, 1993). According to species, the following has been observed (Boudouresque, 1999a): (i) Zero to slight impact. (ii) More or less drastic change in the number and/or abundance of native species (e.g. in macrophyte communities invaded by *Caulerpa taxifolia*). (iii) Displacement of species occupying a close ecological niche. (iv) Change in the functioning of native ecosystems, due to an introduced species which acts as a keystone species (Fig. 8-10). (v) Displacement of native ecosystems, due to the setting up of a totally new ecosystem. This is the case with *Caulerpa taxifolia*, which constitutes a meadow displacing several native ecosystems (e.g. the *Cystoseira brachycarpa* forest, the *Padina pavonica* and *Halopteris scoparia* community, the *Posidonia oceanica* dead mat community, several sand bottom communities and the coralligenous community) and homogenizing habitats and the landscape (Fig. 11). Within a given habitat, alpha species diversity can increase (e.g. sand bottoms and the *Cymodocea nodosa* meadow) or decrease (e.g. the *Posidonia oceanica* meadow and *Cystoseira* forests) (Verlaque and Fritayre, 1994; Verlaque and Boudouresque, 1995; Harmelin-Vivien *et al.*, 1999). However, at region scale, gamma species diversity always decreases (Fig. 11). Synergy between several

invaders, overfishing and climate change can be involved in the setting up of a new ecosystem (Harris and Tyrrell, 2001).

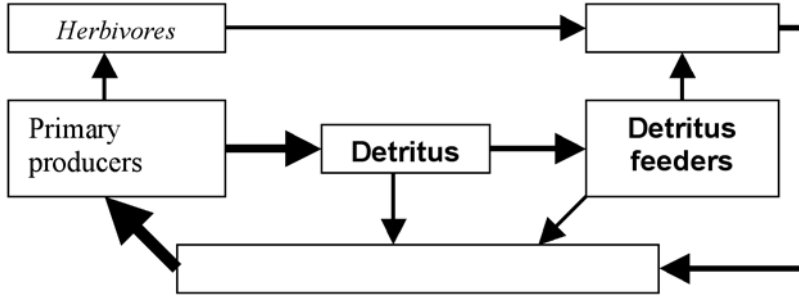

Fig. 8. A simplified model of functioning of many Mediterranean ecosystems (e.g. the *Posidonia oceanica* meadow). Macro-herbivores (e.g. the sea-urchin *Paracentrotus lividus* and the fish *Sarpa salpa*) are generally scarce. Most of the carbon flux runs through detritus.

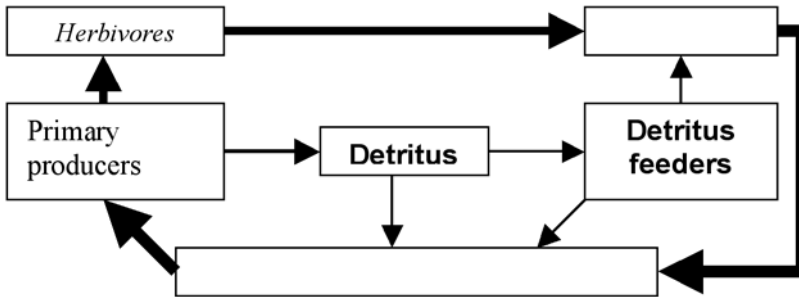

Fig. 9. In the eastern basin of the Mediterranean, the arrival of Red Sea (Lessepsian) herbivorous fish, *Siganus luridus* and *S. rivulatus* probably deflects the carbon flux towards herbivores. In the absence of definite research, this remains a hypothesis.

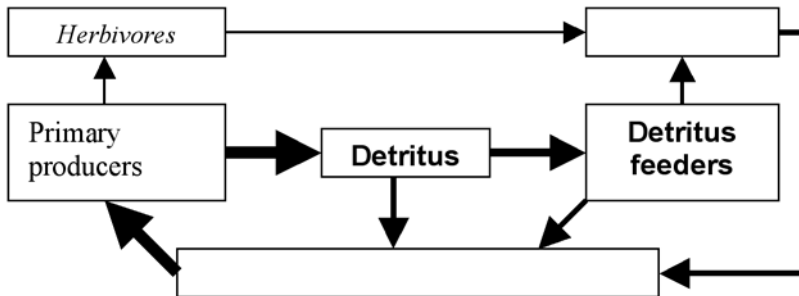

Fig. 10. In contrast, in the northwestern Mediterranean, the introduction of *Caulerpa taxifolia*, a species with powerful defence metabolites against herbivores, can magnify the carbon flux running through the detritus foodweb.

GLOBAL WARMING

Since the 1960s or 1970s, both deep and surface Mediterranean waters have been steadily warming up (Béthoux *et al.*, 1990, 1998; Salat and Pascual, 2002). This warming results from the 1 500-year cycle, the AMO (Atlantic Multidecadal Oscillation), the NAO (North Atlantic Oscillation) and possibly from the greenhouse effect (Bradley, 2000; Kerr, 2000; deMenocal, 2001; deMenocal *et al.*, 2001; Hurrell *et al.*, 2001; McDermott *et al.*, 2001; Tourre, 2002). Biological indicators, i.e. warm water species, react to this warming by extending their range area northwards (Bianchi and Morri, 1993, 1994; Francour *et al.*, 1994). These observations prompt the question: does this warming threaten Mediterranean macrophytes and ecosystems dominated by macrophytes?

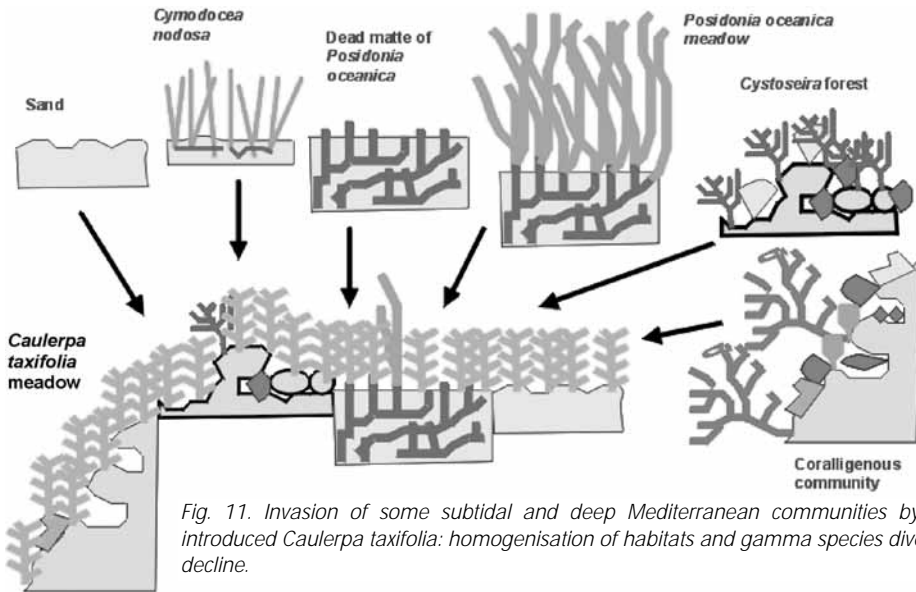

Fig. 11. Invasion of some subtidal and deep Mediterranean communities by the introduced *Caulerpa taxifolia*: homogenisation of habitats and gamma species diversity decline.

Some authors have suggested that the present day flow of introduced species into the Mediter-ra-nean may be a consequence of global warming. Although this warming trend may help tro-pical spe-cies to colonize the Mediterranean, it is worth emphasizing that (i) most recently intro-duced macro-phytes originate from temperate areas, mainly NE Asia (including Japan), via aquaculture, rather than from tropical areas (Boudouresque and Verlaque, 2002) and that (ii) *Caulerpa taxifolia* and *C. racemosa* var. *cylindracea*, two of the most invasive species in the Mediterranean, though usually referred to as "tropical green algae", actually do not originate from tropical waters but from the temperate Southern Australia (the "Mediterranean" Australian province) (Jousson *et al.*, 2000; Meusnier *et al.*, 2001; Verlaque *et al.*, 2003).

At the end of the summer 1999, an unprecedented mass mortality of benthic invertebrates (mainly gorgonians, sponges, ascidians and bryozoans) occurred along the coasts of Provence (France), French Riviera and Liguria (Italy). Exceptionally high temperatures throughout the water column (23-24°C) for over one month, down to 40 m depth, could have created an environmental context favourable to the mass mortality event (Cerrano *et al.*, 2000; Coma *et al.*, 2000; Pérez *et al.*, 2000; Romano *et al.*, 2000). This episode is of particular interest since, should the present day warming trend continue, it could be the harbinger of even more drastic events.

Unfortunately, as far as macrophytes are concerned, very little information is available about the possible effect of the warming up of the Mediterranean water: (i) Some encrusting corallines (Rhodobionta, Plantae) were said to have been affected by the 1999 summer warm episode (Cerrano *et al.*, 2000), but nothing is known about the extent of the phenomenon and the subsequent recovery. (ii) The native *Caulerpa prolifera* (Chlorobionta, Plantae) is extending its range area northwards, from Corsica, the Tyrrhenian Sea and the French Riviera to Liguria and Provence (Bianchi and Morri, 1994 and unpublished data). Outside the Mediterranean, in the Gulf of Maine (USA), a synergy between climate change and introduced species has been observed (Harris and Tyrrell, 2001).

A CASE STUDY: THE DECLINE OF *CYSTOSEIRA* FORESTS

More than 50 taxa belonging to the genus *Cystoseira* (Fucophyceae, Chromobionta, Stramenopiles) thrive in the Mediterranean Sea (Ribera *et al.*, 1992). Most of them are key-species in a variety of forest communities which are encountered on subtidal and circalittoral hard bottoms (Giaccone and Bruni, 1972-1973). In addition, they are usually K strategists and long-lived (at least 45 years for *C. spinosa*; Ballesteros *et al.*, 1995, 1998).

Since the 1960s, *Cystoseira* forests have undergone a severe decline in extensive areas of the Mediterranean. Several species of *Cystoseira* and the communities they dominate are considered as threatened (Boudouresque *et al.*, 1990). The decline of *C. amentacea*, which thrives in the subtidal fringe under strong surf exposure, has been related to pollution (Bellan-Santini, 1966). The regression of deeper *Cystoseira* forests (e.g. *C. brachycarpa*, *C. spinosa* and *C. zosteroides*) may be due to a cascade effect (*sensu* Steneck, 1998), though other causes may be involved (Sala *et al.*, 1998): over-fishing of sea-urchin predator fish (e.g. *Sparus aurata*) leads to a surge in numbers of the browser *Paracentrotus lividus*, which in turn overgrazes benthic macrophytes, especially palatable and strongly preferred (Verlaque and Nédélec, 1983; Lemée *et al.*, 1996) *Cystoseira* species, which results in "barren grounds" with only encrusting corallines, ephemeral macrophytes and sea-urchins (Verlaque, 1987a; Sala *et al.*, 1998; Boudouresque and Verlaque, 2001). Other causes of more local significance can be put forward to explain the *Cystoseira* forest's decline, e.g. turbidity (which diminishes irradiance and therefore the compensation depth), silting, gill nets and trawling.

The recovery of *Cystoseira* forests, after the causes of their decline have ceased to operate, generally takes a very long time. Eight years after the setting up of the Marseilles (Provence, France) sewage treatment plant, the recovery of *Cystoseira amentacea* was hardly discernible (Soltan, 2001; Soltan *et al.*, 2001). The reason may be that *Cystoseira* eggs are rather large, sink rapidly and therefore are probably not disseminated beyond a few meters from parent individuals (Guern, 1963, 1964; Lüning, 1990), as occurs in *Sargassum* species (Chapman, 1986). In addition, the growth of most *Cystoseira* species is quite slow (Verlaque, 1987b). As a result, where *C. amentacea* has been extirpated from large areas, step-by-step recovery can take decades (Soltan *et al.*, 2001). The absence of colonization by *Cystoseira* species of some breakwaters constructed decades ago (and apparently suitable) highlights the difficulty of these species in colonizing new or lost habitats.

A CASE STUDY: THE FATE OF *LITHOPHYLLUM BYSSOIDES* TROTTOIRS

The encrusting coralline *Lithophyllum byssoides* (Rhodobionta, Plantae), previously known as *L. lichenoides* or *L. tortuosum*, lives in the lower midlittoral zone, i.e. slightly above mean sea level. Under conditions of dim light and strong surf exposure, e.g. in small coves, corridors, fends, crannies and along cliffs, it builds up rims; wide rims are usually named "trottoirs". They consist of a wide overhanging cornice with a flat or slightly depressed upper surface, ending in a salient rim with a vertical face (Delamare-Deboutville and Bougis, 1951; Blanc and Molinier, 1955; Pérès and Picard, 1964; Laborel, 1987; Laborel *et al.*, 1994a).

The *Lithophyllum byssoides* rim is a common feature in the northern and central parts of the western Mediterranean basin and the Adriatic Sea. The most spectacular trottoirs are those of Grand Langoustier on Porquerolles Island (Provence, France), Cala Litzia (Punta Palazzu, Scandola nature Reserve, Corsica) and Kvarner Gulf (Croatia). They are 2 m wide in places. *Lithophyllum byssoides* rims are less common in the south of the western basin and very rare in the eastern basin (Huvé, 1963; Lovric, 1971; Zimmermann, 1982; Bianconi *et al.*, 1987; Harmelin *et al.*, 1987; Laborel, 1987; Laborel *et al.*, 1994a).

Datings by ^{14}C have shown that the building up of large *Lithophyllum byssoides* trottoirs takes several centuries, even more than a thousand years, and a relatively stable (or just very slowly rising) sea level, which has rarely been the case over the last 30 000 years (Laborel *et al.*, 1983, 1994b).

The *Lithophyllum byssoides* trottoir is sensitive to pollution (especially hydrocarbons). The trottoirs have died in French Catalonia, in the Marseilles area (France) and in the Gulf of Palermo (Sicily): bio-erosion (perforating organisms) no longer being compensated for by bio-construction, they are progressively eroded and end up disappearing (Laborel *et al.*, 1994a; Riggio *et al.*, 1994). Bearing in mind the length of time it takes for them

to be built up, this disappearance must be considered irreversible from the human point of view (even when the causes of death are believed to have been removed).

Lithophyllum byssoides trottoirs are also threatened by constant treading: the platform of Cala Litzia (Scandola nature Reserve, Corsica), well publicised as a high value natural monument, was visited by growing numbers of tourists who arrived there in rubber dinghies. *Lithophyllum byssoides* dies if it is walked over too often. In addition, at the side of the platform, rope marks could be observed (dinghy moorings) (Verlaque, 1996). For these reasons, at the request of the Scientific Committee of the Scandola Nature Reserve, access to the Cala Litzia *L. byssoides* trottoir is now prohibited.

Finally, the expected relative rising of the mean sea-level, rapid in terms of geological scale, resulting from global warming (Pernetta and Elder, 1992), threatens in the long term the *L. byssoides* rims and trottoirs. The building up of this bio-construction is linked to a stable or very slowly rising sea-level (see above).

CONCLUSIONS

Researchers' attention with regard to anthropogenic impact on marine vegetation has been mainly focused on pollution although, in the long term, this is far from being the greatest cause for concern. The Mediterranean marine vegetation is mainly threatened by coastal development, species introduction and global warming, which are irreversible events, at least at human scale. In addition, the regression of long-lived species, such as *Cystoseira* ssp. and of *Lithophyllum byssoides* trottoirs, whose construction takes several centuries, jeopardizes present day nature conservation policy.

Unfortunately, scientific knowledge of the consequences of these threats is rather sparse and, above all, policy makers and stakeholders still ingenuously consider that reducing pollution will solve all environmental problems.

ACKNOWLEDGEMENTS

The authors are indebted to Michael Paul for improving the English text.

REFERENCES

- Allué-Puyelo R., Olivella-Prats I. (1994) - Actions pour la protection et la conservation du littoral catalan. In: Actes du colloque scientifique Okéanos "Pour qui la Méditerranée au 21^e siècle ? Villes des rivages et environnement littoral en Méditerranée". Montpellier: 196-208.
- Astier J.M. (1984) - Impact des aménagements littoraux de la rade de Toulon, liés aux techniques d'endigage, sur les herbiers à *Posidonia oceanica*. In: International Workshop on *Posidonia oceanica* beds, Boudouresque C.F., Jeudy de Grissac A., Olivier J. (eds.), GIS Posidonie publ., Marseille, : 255-259.
- Astier J.M., Castel A., Tailliez P., Tiné J. (1980) - L'aménagement des plages artificielles du Mourillon. Rev. Fond. océanogr. Ricard, 4: 14-23.
- Baldauf S.L. (2003) – The deep roots of Eucaryotes. Science, 300: 1703-1706.

- Ballesteros E., Sala E., Garrabou J., Zabala M. (1995) - Estudio preliminar sobre una población de *Cystoseira spinosa* Sauvageau de la Reserva natural de Scandola (Córcega). Rapport Parc naturel régional de Corse: 36 pp.
- Ballesteros E., Sala E., Garrabou J., Zabala M. (1998) - Community structure and frond size distribution of a deep water stand of *Cystoseira spinosa* (Phaeophyta) in the Northwestern Mediterranean. Eur. J. Phycol., 33: 121-128.
- Bellan G., Bourcier M., Salen-Picard C., Arnoux A., Casserley S. (1999) - Benthic ecosystem changes associated with wastewater treatment at Marseille : implications for the protection and restoration of the Mediterranean shelf ecosystem. Water Environment Research, 71 (4): 483-493.
- Bellan-Santini D. (1966) - Influence des eaux polluées sur la faune et la flore marines benthiques dans la région marseillaise. Techn. Sci. municipales, Fr., 61 (7): 285-292.
- Béthoux J.P., Gentili B., Raunet J., Tailliez D. (1990) - Warming trend in the western Mediterranean deep water. Nature, 347 (6294): 660-662.
- Béthoux J.P., Gentili B., Tailliez D. (1998) - Warming and freshwater budget change in the Mediterranean since the 1940s, their possible relation to the greenhouse effect. Geophysical Res. Letters, 25 (7): 1023-1026.
- Bianchi C.N., Morri C. (1993) - Range extensions of warm-water species in the northern Mediterranean : evidence for climatic fluctuations? Porcupine Newsletter, 5 (7): 156-159.
- Bianchi C.N., Morri C. (1994) - Southern species in the Ligurian Sea (Northern Mediterranean) : new records and a review. Bol. Mus. Ist. Biol. Univ. Genova, 58-59: 181-197.
- Bianconi C.H., Boudouresque C.F., Meinesz A., Di Santo F. (1987) - Cartographie de la répartition de *Lithophyllum lichenoides* (Rhodophyta) dans la Réserve naturelle de Scandola (côte orientale de Corse, Méditerranée). Trav. sci. Parc nat. rég. Réserves nat. Corse, 13: 39-63.
- Blanc J.J., Molinier R. (1955) - Les formations organogènes construites superficielles en Méditerranée occidentale. Bull. Inst. océanogr., Monaco, 1067: 1-26.
- Boudouresque C.F. (1997) - Situation de la biodiversité marine et lagunaire en Tunisie. Recommendations. UNEP (United Nations Environment Programme), Regional Activity Center for Marine protected Areas (RAC/SPA). GIS Posidonie publ.: 154 pp.
- Boudouresque C.F. (1999a) Introduced species in the Mediterranean: routes, kinetics and consequences. In: Proceedings of the workshop on invasive *Caulerpa* species in the Mediterranean. MAP Technical Reports Ser., UNEP, Athens: 51-72.
- Boudouresque C.F. (1999b) - The Red Sea - Mediterranean link: unwanted effects of canals. In: Invasive species and biodiversity management, Sandlund O.T., Schei P.J., Viken A. (eds.), Kluwer Academic publ.: 213-228
- Boudouresque C.F., Ballesteros E., Ben Maiz N., Boisset F., Bouladier E., Cinelli F., Cirik S., Cormaci M., Jeudy de Grissac A., Laborel J., Lanfranco E., Lundberg B., Mayhoub H., Meinesz A., Panayotidis P., Semroud R., Sinnassamy J.M., Span A., Vuignier G. (1990) - Livre rouge "Gérard Vuignier" des végétaux, peuplements et paysages marins menacés de Méditerranée. UNEP/IUCN/Gis Posidonie. UNEP MAP technical Series, 43: 1-250.
- Boudouresque C.F., Jeudy de Grissac A. (1983) - L'herbier à *Posidonia oceanica* en Méditerranée : les interactions entre la plante et le sédiment. J. Rech. océanogr., 8 (2-3): 99-122.
- Boudouresque C.F., Meinesz A. (1982) - Découverte de l'herbier de Posidonie. Cah. Parc nation. Port-Cros, Fr., 4: 1-79.

- Boudouresque C.F., Ribera M.A. (1994) - Les introductions d'espèces végétales et animales en milieu marin. Conséquences écologiques et économiques et problèmes législatifs. In: First international workshop on *Caulerpa taxifolia*, Boudouresque C.F., Meinesz A., Gravez V. (eds.), GIS Posidonie publ., Marseille: 29-102.
- Boudouresque C.F., Verlaque M. (2001) - Ecology of *Paracentrotus lividus*. In: Edible sea-urchins: biology and ecology, Lawrence J. (ed.), Elsevier publ., Amsterdam: 177-216
- Boudouresque C.F., Verlaque M. (2002) - Assessing scale and impact of ship-transported alien macrophytes in the Mediterranean Sea. In: Alien marine organisms introduced by ships in the Mediterranean and Black seas, CIESM workshop monographs, 20: 53-61.
- Bradley R. (2000) - 1000 years of climate change. *Science*, 288: 1353-1354.
- Carlton J.T., Geller J.B. (1993) - Ecological roulette: the global transport of nonindigenous marine organisms. *Science*, 261: 78-82.
- Cerrano C., Bavestrello G., Bianchi C.N., Cattaneo-Vietti R., Bava S., Morganti C., Morri C., Picco P., Sara G., Schiaparelli S., Siccardi A., Sponga F. (2000) - A catastrophic mass-mortality episode of gorgonians and other organisms in the Ligurian Sea (North-western Mediterranean), summer 1999. *Ecology Letters*, 3: 284-293.
- Chapman A.R.O. (1986) - Population and community ecology of seaweeds. In: *Advances in marine Biology*, Blaxter J.H.S., Southward A.J. (eds.), Academic Press publ., London, 23: 1-161.
- Charpentier B., Glass B., Kuzucuoglu C., Locq C., Chatain C. (1995) - L'environnement méditerranéen ; contribution française. Ministère de l'Environnement publ., Paris: 1-214.
- Clark R.B. (1986) - Marine pollution. Oxford Univ. Press publ., Oxford: xiii + 215 pp.
- Cognetti G., Cognetti G. (1992) - Inquinamenti e protezione del mare. Calderinu publ., Bologna: x + 318 pp.
- Coma R., Dantart L., Diaz D., Garrabou O., Hereu B., Linares C., Zabala M. (2000) - Mass mortality and recovery of red gorgonian (*Paramuricea clavata*) in the Port-Cros marine National Park (Var, France). *Universitat de Barcelona publ.* : 1-47.
- Delamare-Deboutville C., Bougis P. (1951) - Recherches sur le trottoir d'algues calcaires effectuées à Banyuls pendant le stage d'été 1950. *Vie Milieu*, 2 (2): 161-181.
- deMenocal P.B. (2001) - Cultural responses to climate change during the late Holocene. *Science*, 292: 667-673.
- deMenocal P., Ortis J., Guilderson T., Sarnthein M. (2000) - Coherent high- and low-latitude climate variability during the Holocene warm periode. *Science*, 288: 2198-1202.
- Dimech M., Borg J.A., Schembri P.J. (2002) - Changes in the structure of a *Posidonia oceanica* meadow and in the diversity of associated decapod, mollusc and echinoderm assemblages, resulting from inputs of waste from a marine fish farm (Malta, central Mediterranean). *Bull. mar. Sci.*, 71 (3): 1309-1321.
- Francour P., Boudouresque C.F., Harmelin J.G., Harmelin-Vivien M.L., Quignard J.P. (1994) - Are the Mediterranean waters becoming warmer ? information from biological indicators. *Mar. Poll. Bull.*, 28 (9): 523-526.
- Giaccone G., Bruni A. (1972-1973) - Le cystoseire e la vegetazione sommersa del Mediterraneo. *Atti Inst. vene-to Sci., Lett. Arti*, 131: 59-103.
- Gravez V., Niéri M., Boudouresque C.F. (1992) - Surveillance de l'herbier de Posidonie de la baie du Prado (Mar-seille). Rapport de synthèse 1986-1992. Direction Générale des Services techniques de la Ville de Marseille et GIS Posidonie publ., Marseille: 80 pp.

- Gray J.S. (2000) - The measurement of marine species diversity, with an application to the benthic fauna of the Norwegian continental shelf. *J. exp. mar. Biol. Ecol.*, 250: 23-49.
- Gray J.S. (2001) - Marine diversity: the paradigms in patterns of species richness examined. *Scientia marina*, 65 (suppl. 2): 41-56.
- Guern M. (1963) - Embryologie de quelques espèces du genre *Cystoseira* Agardh 1821 (Fucales). *Vie Milieu*, 13 (4): 649-679.
- Guern M. (1964) - Sur quelques particularités du développement des oeufs chez les *Cystoseira* (Fucales). In: Proc. internation. Seaweed Symp., Biarritz, sept. 1961, Pergamon Press publ., Oxford, 4: 78.
- Harmelin J.G., Vacelet J., Petron C. (1987) - Méditerranée vivante. Promenades à la rencontre de la faune et de la flore. Glénat publ., Grenoble: 259 pp.
- Harmelin-Vivien M., Francour P., Harmelin J.G. (1999) - Impact of *Caulerpa taxifolia* on Mediterranean fish assemblages: a six year study. In: Proceedings of the workshop on invasive *Caulerpa* in the Mediterranean. Heraklion, Crete, Greece, 18-20 March 1998. UNEP publ., Athens, Greece: 127-138.
- Harris L.G., Tyrrell M.C. (2001) - Changing community states in the gulf of Maine: synergism between invaders, overfishing and climate change. *Biol. Invasions*, 3: 9-21.
- Hurrell J.W., Kushnir Y., Visbeck M. (2001) - The North Atlantic Oscillation. *Science*, 291: 603-604.
- Huvé H. (1963) - Données écologiques et biogéographiques relatives à quelques Mélobésiées méditerranéennes caractéristiques des niveaux superficiels de la roche littorale. *Rapp. P.V. Réunion. Comm. intern. Explor. sci. Mé-dit*, Monaco, 17 (2): 147-160.
- Jousson O., Pawlowski J., Zaninetti L., Zechman E.W., Dini F., Di Guiseppe G., Woodfield R., Millar A., Meinesz A. (2000) - Invasive alga reaches California. *Nature*, 408: 157-158.
- Kerr R.A. (2000) - A North Atlantic climate pacemaker for the centuries. *Science*, 288: 1984-1986.
- Kumar S., Rzhetsky A. (1996) - Evolutionary relationships of Eucaryotic kingdoms. *J. mol. Evol.*, 42: 183-193.
- Laborel J. (1987) - Marine biogenic constructions in the Mediterranean. *Sci. Rep. Port-Cros nation. Park*, 13: 97-126.
- Laborel J., Boudouresque C.F., Laborel-Deguen F. (1994a) - Les bioconcrétionnements littoraux de Méditerranée. In: Les biocénoses marines et littorales de Méditerranée, synthèse, menaces et perspectives, Bellan-Santini D., Lacaze J.C., Poizat C. (eds.), Muséum National d'Histoire Naturelle publ., Paris: 88-97.
- Laborel J., Delibrias G., Boudouresque C.F. (1983) - Variations récentes du niveau marin à Port-Cros (Var, France), mises en évidence par l'étude de la corniche littorale à *Lithophyllum tortuosum*. *C.R. hebdom. Séances Acad. Sci.*, Paris, 297: 157-160.
- Laborel J., Morhange C., Lafont R., Le Campion J., Laborel-Deguen F., Sartoretto S. (1994b) - Biological evidence of sea-level rise during the last 4 500 years on the rocky coasts of continental southwestern France and Corsica. *Marine Geology*, 120: 203-223.
- Lecointre G., Le Guyader H. (2001) - Classification phylogénétique du vivant. Belin publ., Fr.: 543 pp + 15 pl.
- Lemée R., Boudouresque C.F., Gobert J., Malestroit P., Mari X., Meinesz A., Menager V., Ruitton S. (1996) - Feeding behaviour of *Paracentrotus lividus* in presence of *Caulerpa taxifolia* introduced in the Mediterranean. *Oceanologica Acta*, 19 (3-4): 245-253.
- Lovric A.Z. (1971) - *Lithophyllum tortuosum* rediscovered in the Kvarner Gulf (Northern Adriatic). *Acta bot. Croat.*, 30: 109-112.
- Lüning K. (1990) - Seaweeds, their environment, biogeography and ecophysiology. Wiley Interscience Publ., Wiley and Sons publ., New York: 527 pp.

- Marchand M. (1981) - Amoco Cadiz. Bilan du colloque sur les conséquences d'une pollution accidentelle par les hydrocarbures. Brest – Novembre 1979. Rapp. sci. techn. CNEXO, Fr., 44: 1-86.
- McDermott F., Matthey D.P., Hawkesworth C. (2001) - Centennial-scale Holocene climate variability revealed by a high-resolution speleothem δO^{18} record from SW Ireland. *Science*, 294: 1328-1330.
- Meinesz A., Astier J.M., Bodoy A., Cristiani G., Lefevre J.R. (1982) - Impact de l'aménagement du domaine maritime sur l'étage infralittoral des Bouches-du-Rhône (France, Méditerranée occidentale). *Vie Milieu*, 32 (2): 115-124.
- Meinesz A., Astier J.M., Lefevre J.R. (1981) - Impact de l'aménagement du domaine maritime sur l'étage infra-littoral du Var, France (Méditerranée occidentale). *Ann. Inst. océanogr.*, 57 (2): 65-77.
- Meinesz A., Lefevre J.R., Astier J.M. (1991) - Impact of coastal development on the infralittoral zone along the southern Mediterranean shore of continental France. *Mar. Poll. Bull.*, 23: 343-347.
- Meusnier I., Olsen J.L., Stam W.T., Destombe C., Valero M. (2001) - Phylogenetic analyses of *Caulerpa taxifolia* (Chlorophyta) and of its associated bacterial microflora provide clues to the origin of the Mediterranean introduction. *Molecular Ecology*, 10: 931-946.
- Pennisi E. (2003) - Modernizing the tree of life. *Science*, 300: 1694-1697.
- Pérès J.M., Picard J. (1964) - Nouveau manuel de bionomie benthique de la Mer Méditerranée. *Rec. Trav. Stat. mar. Endoume, Fr.*, 31 (47): 3-137.
- Pérez T., Garrabou J., Sartoretto S., Harmelin J.G., Francour P., Vacelet J. (2000) - Mortalité massive d'invertébrés marins : un événement sans précédent en Méditerranée nord-occidentale. *C.R. Acad. Sci., Life Sci.*, 323: 853-865.
- Pernetta J.C., Elder D.L. (1992) - Climate, sea-level rise and the coastal zone: management and planning for global changes. *Ocean coast. Management*, 18: 113-160.
- Peterson C.H., Rice S.D., Short J.W., Esler D., Bodkin J.L., Ballachey B.E., Irons D.B. (2003) – Long-term ecosystem response to the Exxon Valdez oil spill. *Science*, 302: 2082-2086.
- Poggiale J.C., Dauvin J.C. (2001) - Long-term dynamics of three benthic *Ampelisca* (Crustacea-Amphipoda) populations from the Bay of Morlaix (western English Channel) related to their disappearance after the "Amoco Cadiz" oil spill. *Mar. Ecol. Progr. Ser.*, 214: 201-209.
- Raffin J.P., Platel R., Meunier F.J., Francillon-Vieillot H., Godineau J.C., Ribier J. (1991) - Etude sur dix ans (1978-1988) de populations de Mollusques (*Patella vulgata* L. et *Tellina tenuis* Da Costa), après pollution pétrolière (Amoco Cadiz). *Bull. Ecol.*, 22 (3-4): 375-388.
- Ramade F. (1994) - Qu'entend-t-on par Biodiversité et quels sont les problématiques et les problèmes inhérents à sa conservation? *Bull. Soc. entomol. Fr.*, 99 (num. spécial): 7-18.
- Ribera M.A. (1994) - Les macrophytes marins introduits en Méditerranée: biogéographie. In: *Introduced species in European coastal waters*, Boudouresque C.F., Briand F., Nolan C. (eds.), European Commission publ., Luxembourg: 37-43.
- Ribera M.A., Boudouresque C.F. (1995) - Introduced marine plants, with special reference to macroalgae: mechanisms and impact. In: *Progress in phycological Research*, Round F.E., Chapman D.J. (eds.), Biopress Ltd publ., UK, 11: 187-268.
- Ribera M.A., Gómez-Garreta A., Gallardo T., Cormaci M., Furnari G., Giaccone G. (1992) – Check-list of Mediterranean seaweeds. I. Fucophyceae (Warming, 1884). *Botanica marina*, 35: 109-130.
- Riggio S., Calvo S., Frada-Orestano C., Chemello R., Arculeo M. (1994) - La dégradation du milieu dans le golfe de Palerme (Sicile Nord-Ouest) et les perspectives d'assainissement. In: *Actes du colloque scientifique Okéanos "Pour qui la Méditerranée au 21^e siècle? Villes des rivages et environnement littoral en Méditerranée"*, Montpellier: 82-89.

Romano J.C., Bensoussan N., Younes W.A.N., Arlhac D. (2000) - Anomalie thermique dans les eaux du golfe de Marseille durant l'été 1999. Une explication partielle de la mortalité d'invertébrés fixés? C.R. Acad. Sci., Life Sci., 323: 415-427.

Sala E., Boudouresque C.F., Harmelin-Vivien M. (1998) - Fishing, trophic cascades and the structure of algal assemblages: evaluation of an old but untested paradigm. *Oikos*, 82: 425-439.

Salat J., Pascual J. (2002) - The oceanographic and meteorological station at L'Estartit (NW Mediterranean). In: Tracking long-term hydrological change in the Mediterranean Sea, CIESM Workshop Series, 16: 29-32.

Schmitz D.C., Simberloff D. (1997) - Biological invasions: a growing threat. *Issues Sci. Technol.*, 13 (4): 33-40.

Soltan D. (2001) - Etude de l'incidence de rejets urbains sur les peuplements superficiels de macroalgues de Méditerranée. Thèse Doctorat, University of the Mediterranean, Marseille: 157 pp.

Soltan D., Verlaque M., Boudouresque C.F., Francour P. (2001) - Changes in macroalgal communities in the vicinity of a Mediterranean sewage outfall after the setting up of a treatment plant. *Mar. Poll. Bull.*, 42 (1): 59-70.

Steneck R.S. (1998) - Human influences on coastal ecosystems: does overfishing create trophic cascades? *Trends Ecol. Evol.*, 13: 429-430.

Tourre Y. (2002) - The North Atlantic Oscillation and the Arctic Oscillation. *Medias Newsletter*, 13: 8-10.

Verlaque M. (1987a) - Relations entre *Paracentrotus lividus* (Lamarck) et le phytobenthos de Méditerranée occidentale. In: Colloque international sur *Paracentrotus lividus* et les oursins comestibles, Boudouresque C.F. (ed.), GIS Posidonie publ., Marseille: 5-36.

Verlaque M. (1987b) - Contribution à l'étude du phytobenthos d'un écosystème photophile thermophile marin en Méditerranée occidentale. Etude structurale et dynamique du phytobenthos et analyse des relations faune-flore. Thèse Doctorat Etat Sciences, University of Aix-Marseille II: 389 p. + 96 pl. + 26 appendices.

Verlaque M. (1996) - Etude des encorbellements à *Lithophyllum lichenoides* de la réserve naturelle de Scandola. Année 1995. Parc naturel régional de Corse and GIS Posidonie, Marseille: 40 p.

Verlaque M., Boudouresque C.F. (1995) - Etude floristique et structurale de la prairie à *Caulerpa taxifolia* du Cap-Martin (Alpes-Maritimes, France). *Rapp. Commiss. internation. Mer Médit.*, Monaco, 34: 48.

Verlaque M., Durand C., Huisman J.M., Boudouresque C.F., Le Parco Y. (2003) - On the identity and origin of the Mediterranean invasive *Caulerpa racemosa* (Caulerpales, Chlorophyta). *Eur. J. Phycology*, 38: 325-339.

Verlaque M., Fritayre P. (1994) - Modifications des communautés algales méditerranéennes en présence de l'algue envahissante *Caulerpa taxifolia* (Vahl) C. Agardh. *Oceanologica Acta*, 17 (6): 659-672.

Verlaque M., Nédélec H. (1983) - Biologie de *Paracentrotus lividus* (Lamarck) sur substrat rocheux en Corse (Méditerranée, France). Alimentation des adultes. *Vie Milieu*, 33 (3-4): 191-201.

Wilson M.V., Shmida A. (1984) - Measuring beta diversity with presence-absence data. *J. Ecol.*, 72: 1055-1064.

Zimmermann L. (1982) - Anmerkungen zur Verbreitung, Bionomie und Taxonomischen Stellung von *Lithophyllum tortuosum* (Esper) Foslie und anderen biogenen Gesteinsbildern im Mittelmeer. *Senckenbergiana marit.*, 14 (1-2): 9-21.

FLORISTIC SIMILARITY AND DISCONTINUITY IN PHYTOGEOGRAPHIC MEDITERRANEAN REGIONS

Giuseppe GIACCONE, Giovanni FURNARI & Mario CORMACI

Dipartimento di Botanica dell'Università di Catania, via A. Longo 19, I-95125 Catania, Italy

ABSTRACT

Both floristic and geobotanic characteristics of the benthic macroalgal flora of Italy are discussed. The flora, obtained from literature records since 1950, consists of 869 (510 Rhodophyta, 205 Phaeophyta and 154 Chlorophyta) taxa accepted under current taxonomy. Ceramiales, Fucophyceae and Chlorophyceae of such a flora were separately compared with corresponding taxonomic lists of the following Mediterranean regions: Spain; France; Greece and Turkey; Libya, Egypt and Levant States (Syria, Lebanon and Israel); Morocco, Algeria and Tunisia. From that comparison it appears that the benthic macroalgal flora of the Italian coast is the richest in species, probably because it was the most studied especially in the last years. Hierarchical clustering of the above lists based on both floristic and phytogeographic characteristics were carried out and the results were expressed in dendrograms from which a noticeable floristic similarity among the lists can be drawn since the lists are linked above the 50% level of importance excepting those of the Libya, Egypt and Levant States (30 to 50%), which could represent a floristic discontinuity. However, such a discontinuity, due to the low number of species recorded in that area could depend besides on the insufficient floristic knowledge, on both geomorphologic characteristics of coast and paleoclimatic events like sapropel crises. But, from dendrograms based on chorological spectra, it results a more marked degree of similarity among the lists that are linked above the 75% level of importance.

The first floristic knowledge of the benthic marine macroalgae of Italy is mainly due to papers published in the second half of the XIX century by C. Agardh (1822-23; 1828), J. Agardh (1842, 1851-1863), Ardissonne (1883, 1886-87), Kützing (1849, 1854-69), Meneghini (1842-46).

Some more authors report, in their papers, algae from limited and/or particular areas: for example De Toni & Levi (1885-88), Hauck (1882-85), Naccari (1828), Schiffner (1914-26), Zanardini (1841, 1843, 1847, 1858, 1860-71), report algae only from the Adriatic Sea; Solms-Laubach (1881), Delle Chiaje (1829), Reinke (1878), Berthold (1884), Vallante (1883), Falkenberg (1879, 1901), Mazza (1902), from the Gulf of Naples; others like Tornabene (1846), Philippi (1837), Langenbach (1873), Borzi (1886), Piccone (1889), Spinelli (1905), only from Sicilian coast.

Species quoted in the above papers, almost all reported in the huge Sylloge algarum by De Toni (1889-1924), form the "historical" benthic macroalgal flora of the Italian coast. De Toni's Sylloge, which represents the compendium of the algal floristic knowledge to that date, marks the conclusion of the first season of algological studies of Italian coast. Then, one must wait the sixties for the beginning of a second season of algological

studies dealing with Italian coast that has had and has still as main actors the present generation of Italian phycologists.

In fact, from 1925 to 1964, only few papers were published: by Schiffner & Vatova (1937) on algae from the Lagoon of Venice; by Levring (1942) on some algae from the Adriatic Sea, Sicily and the Gulf of Naples; by Funk (1927 and 1955) on the marine vegetation and on the benthic algal flora of the Gulf of Naples, respectively; by Molinier & Picard (1953) on some vegetational observations of the Sicilian coast; by Cavaliere (1957, 1959, 1960) on some algae from the Straits of Messina. Conversely, from 1962 to date very numerous algological papers were produced. Except for the paper by Pignatti (1962) on the Lagoon of Venice, such papers first dealt only with both northern and southern coast of Sicily: the Gulf of Palermo (Giaccone & De Leo 1966), the Island of Femmine (Palermo) (Giaccone & Sortino 1964), cape Zafferano (Palermo) (Giaccone 1965), Palma di Montechiaro (Agrigento) (Sortino 1967), the harbour of Licata (Agrigento) (Sortino 1968). Then, from 1970 to date, they dealt with eastern coast of Sicily (Furnari & Scammacca 1970a,b; 1971, 1973; Cormaci *et al.* 1976, 1978; Cormaci & Furnari 1979a,b; Battiato & Ponte 1975,1978; Battiato *et al.* 1978), the Straits of Messina (Codomier & Giaccone 1972; Giaccone & Rizzi Longo 1976), the Straits of Sicily (Giaccone *et al.* 1972), the Island of Ustica and the Aeolian Islands (Giaccone 1971; Giaccone *et al.*, 1985), the Island of Pantelleria (Giaccone *et al.* 1973), the Egadi Islands (Giaccone & Sortino 1974), the Island of Linosa (Cinelli *et al.* 1976), the Tuscanian coast (Tyrrhenian Sea) (Cinelli 1969, 1971a; Papi & *et al.* 1992; Pignatti & Rizzi 1972), the southern Tyrrhenian Sea (the Aeolian Islands and the Island of Ustica included) (Boudouresque & Cinelli 1971; Cinelli 1971b; Gargiulo *et al.* 1985; Alongi & *et al.* 1993; Cormaci *et al.* 1992), the Sardinia (Cossu *et al.* 1992; Solazzi 1969), the Liguran Sea (Benedetti-Cecchi & Cinelli 1992), the Adriatic Sea (the Tremiti Island included) (Giaccone 1978; Furnari *et al.* 1999; Solazzi 1965, 1967; 1976), the high Ionian Sea (Cecere *et al.* 1991, 1996) and the Island of Lampedusa (Scammacca *et al.* 1993).

However, in spite of the publication of the above mentioned papers, the floristic knowledge of the benthic marine macroalgae of Italian coast is still irregular and not complete. In fact, while some areas resulted well studied (e.g. the Gulf of Naples, Sicily and adjacent islands, the high Adriatic Sea, the Tremiti Islands, the Gulf of Taranto), some others are still insufficiently studied (e.g. the Ligurian Sea, Sardinia, the coast of Latium, the coast of Calabria, etc.).

With a grant of the Italian Ministry of the Environment, Furnari *et al.* (2003) have compiled a check-list of the benthic macroalgal Italian flora. In order to give a picture as much corresponding as possible to the present composition, only references published since 1950 have been used. Over 600 papers were considered, in which a total of 1120 taxa at specific and infraspecific level were reported. Following a critical taxonomic and nomenclatural revision, apart from 56 Cyanophyta, 79 *taxa inquirenda* (the taxonomic value of which remains uncertain without a revision of herbarium specimens) and 31 *taxa excludenda* (the records of which are probably due to misidentifications since refer to species not present in the Mediterranean Sea) not considered in this paper, the Italian flora resulted of 509 Rhodophyta, 208 Phaeophyta and 154 Chlorophyta for a total of

871 accepted taxa (Table 1). However, it should be noted that most species of the *Laurencia complex* and of nongeniculate Coralline algae were only tentatively included in the accepted taxa. In fact, because the taxonomy of such groups has recently undergone substantial reassessments, in absence of the study of herbarium specimens, the occurrence of most of such species should be confirmed.

Table 1. The macroalgal Italian flora: composition of the whole flora, of floras of each FAO sector (sector 3: Tyrrhenian Sea and adjacent basins; sector 4: Adriatic Sea; sector 5: Ionian Sea), of common species to all sectors as well as of sole species of each sector.

	Italy	sector 3	sector 4	sector 5	common species	sole species of sector 3	sole species of sector 4	sole species of sector 5
Rhodophyta	510 58.7%	470 61.2%	340 58.9%	444 63.2%	314	44	4	32
Phaeophyta	205 23.6%	169 21.9%	124 21.5%	148 21.1%	93	26	21	15
Chlorophyta	154 17.7%	130 16.9%	113 19.6%	110 15.7%	84	20	14	5
Total	869	769 88.5%	577 66.4%	702 80.8%	491 56.5%	90 10.3%	39 4.5%	52 6.0%

Since the Italian coasts (Fig. 1) fall within the FAO fishing sectors 3 (Tyrrhenian Sea and adjacent basins), 4 (Adriatic Sea) and 5 (Ionian Sea), the floristic consistency of each sector was calculated.

The flora of the sector 3 is the richest with 769 taxa (470 Rhodophyta, 169 Phaeophyta and 130 Chlorophyta), followed by that of the sector 5 with 702 taxa (444 Rhodophyta, 148 Phaeophyta and 110 Chlorophyta) and by that of the sector 4 that resulted the poorest with 577 taxa (340 Rhodophyta, 124 Phaeophyta and 113 Chlorophyta). The three sectors share 491 taxa (equal to 56.5%), while 90 taxa (10.3%) are present only in the sector 3, 39 taxa (4.5%) in the sector 4 and 52 taxa (6.0%) in the sector 5 (Table 1). In order to understand the phytogeographic characteristics of the Italian flora, a specific investigation of the areals of every species has been conducted. Following that study, each species was assigned to a distribution-group named according to Cormaci *et al.* (1982). Chorological spectra (Table 2 and Fig. 2) of the Italian flora and of floras of sectors 3 and 5 are characterised by a dominance of the Atlantic element, followed by the Mediterranean, Cosmopolitan, Indo-Pacific, Circumtropical and Circumboreal; only that of the sector 4 shows a different sequence of distribution groups with the dominance of the Atlantic element, followed by the Cosmopolitan, Mediterranean, Circumtropical, Indo-Pacific and Circumboreal.



Fig. 1. Map of Italy showing FAO Sectors

Table 2. Chorological spectra of the whole macroalgal Italian flora and of floras of each FAO sector.

Distribution groups	Italy	sector 3	sector 4	sector 5
Atlantic	388 44.7%	342 44.5%	253 43.8%	302 43.0%
Mediterranean	238 27.4%	204 26.5%	132 22.9%	180 25.6%
Cosmopolitan	156 18.0%	147 19.1%	137 23.7%	145 20.7%
Indo-Pacific	40 4.6%	33 4.3%	20 3.5%	32 4.6%
Circumtropical	33 3.8%	31 4.0%	24 4.2%	29 4.1%
Circumboreal	14 1.6%	12 1.6%	11 1.9%	14 2.0%

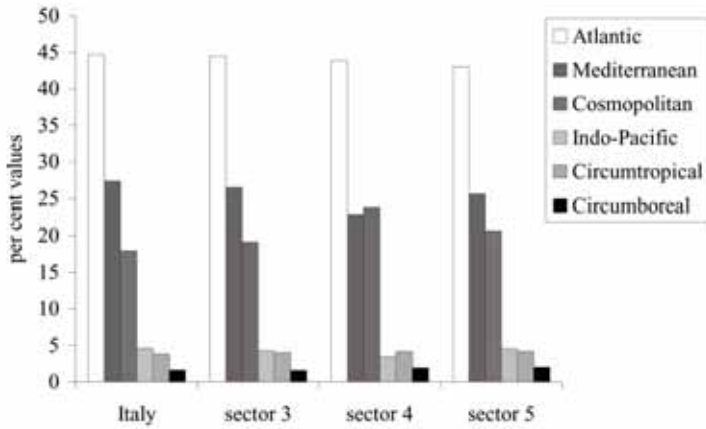

Fig. 2. Histogram showing the percentages of species of the Italian flora and of floras of each FAO sector belonging to each distribution group.

The floras of the three sectors have been compared so as to establish the degree of both floristic and phytogeographic similarities among them, as expressed by Jaccard's (1932) and Kulczynski's (1927) similarity indices, respectively. A hierarchical clustering was then carried out with an agglomerative centroid method (Sokal & Sneath 1963). The results are expressed in the dendrograms of Figs. 2-3. The dendrogram of Fig. 3 shows a remarkable similarity between the floras of the Tyrrhenian Sea and the Ionian Sea being linked to a level of importance near to 80%, while that of the Adriatic Sea is linked to the previous group to a level of importance of about 65%. The same pattern of similarity, but with linkages at higher level of importance, is shown by the dendrogram based on chorological spectra (Fig. 4). In both cases the Adriatic flora could represent a discontinuity probably due to the lowest total number of species and to the lowest per cent value of the Mediterranean element, from a floristic and a phytogeographic point of view, respectively. The relatively low per cent value of the Mediterranean element in the Adriatic flora is probably due to the limited extension of the rocky circalittoral zone where Mediterranean element is generally dominant (Boudouresque 1973).

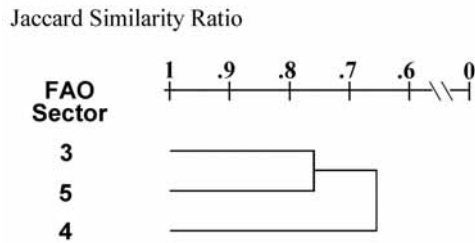

Fig. 3. Dendrogram depicting mutual floristic similarities of floras of the three FAO sectors.

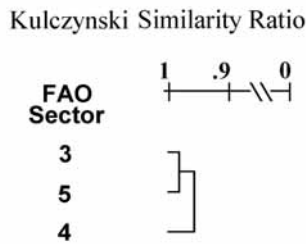

Fig. 4. Dendrogram depicting mutual chorological similarities of floras of the three FAO sectors.

In the last years, three check-lists of Mediterranean Fucophyceae, Chlorophyceae and Ceramiales, based on references since 1950, were compiled by Ribera *et al.* (1992), Gallardo *et al.* (1993) and Gómez Garreta *et al.* (2001), respectively. From such papers we drew lists of Fucophyceae, Chlorophyceae and Ceramiales of five Mediterranean areas delimited as follows: (SPA) Spain, (FRA) France, (GTR) Greece and Turkey, (LEL) Libya, Egypt and Levant States (Syria, Lebanon and Israel), (MAT) Morocco, Algeria and Tunisia. Then, the above lists were compared with the corresponding systematic lists of the Italian coast (ITA). From this comparison it resulted that the number of specific and infraspecific taxa accepted for the Mediterranean Sea is 243 Fucophyceae, 178 Chlorophyceae and 260 Ceramiales (Table 3). Italy and France resulted the richest in species areas with 215 (82.7%) and 214 Ceramiales (82.3%), 205 (84.3%) and 157 (64.6%) Fucophyceae, 154 (86.5%) and 122 (68.5%) Chlorophyceae, respectively. Conversely, the LEL area resulted the poorest in species with only 128 (49.2%) Ceramiales, 74 (30.4%) Fucophyceae and 72 (40.4%) Chlorophyceae (Table 3). Species common to all areas are 90 Ceramiales (34.6%), 54 Fucophyceae (22.2%) and 48 Chlorophyceae (29.9%) while very few resulted the sole ones: 12 (4.6%), 30 (12.3%), 21 (11.7%) at Italy; 3 (1.1%),

4 (1.6%) and 2 (1.1%) at Spain; 5 (1.9%), 11 (4.5%) and 6 (3.3%) at France; 2 (0.7%), 2 (0.8%) and 2 (1.1%) at GTR; 4 (1.5%), 3 (1.2%) and 5 (2.8%) at LEL; 1 (0.3%), 3 (1.2%) and 2 (1.1%) at MAT of Ceramiales, Fucophyceae and Chlorophyceae, respectively (Table 4). The lists of each systematic group (Ceramiales, Fucophyceae and Chlorophyceae) of the above areas have been compared so as to establish the degree of floristic similarity between each pair of the six areas, using the same methodology as for comparisons within the Italian flora. The results dealing with the Ceramiales are expressed in the dendrogram of Fig. 5. The following groups can be identified: that including SPA and FRA to which ITA is linked at a level of importance higher than 70% and that including GTR and MAT, linked to the previous one at a level slightly higher than 60%, to which LEL is linked at a level of 50%. From the dendrogram, the following conclusions can be drawn: the floristic similarity among areas is remarkable being all linked to a level of importance higher than 60%, except the LEL one (50%).

Table 3. Composition of the six Mediterranean macroalgal floras investigated. ITA (Italy), SPA (Spain), FRA (France), GTR (Greece and Turkey) LEL (Libya, Egypt and Levant States), MAT (Morocco, Algeria and Tunisia). In brackets the total number of species recorded from the Mediterranean Sea.

	ITA	SPA	FRA	GTR	LEL	MAT
Ceramiales (260)	215 82.7%	205 78.8%	214 82.3%	175 67.3%	128 49.2%	174 66.9%
Fucophyceae (243)	205 84.3%	134 55.1%	157 64.6%	120 49.3%	74 30.4%	119 48.9%
Chlorophyceae (178)	154 86.5%	120 67.4%	122 68.5%	95 53.3%	72 40.4%	90 50.5%

Table 4. Number of common species to all Mediterranean floras investigated as well as of sole species of each flora. In the second line per cent values.

	Common species to all floras	Sole species per flora					
		ITA	SPA	FRA	GTR	LEL	MAT
Ceramiales	90 34.6%	12 4.6%	3 1.1%	5 1.9%	2 0.7%	4 1.5%	1 0.3%
Fucophyceae	54 22.2%	30 12.3%	4 1.6%	11 4.5%	2 0.8%	3 1.2%	3 1.2%
Chlorophyceae	48 29.9%	21 11.7%	2 1.1%	6 3.3%	2 1.1%	5 2.8%	2 1.1%

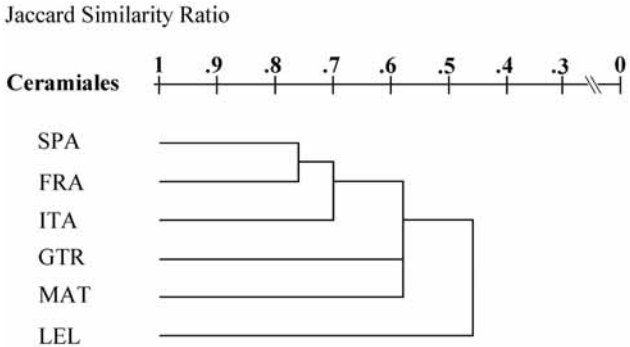

Fig. 5. Dendrogram depicting mutual floristic similarities of Ceramiales of the six floras investigated.

A rather similar dendrogram is that of Chlorophyceae (Fig. 6) in which the following groups can be identified: that including SPA and FRA to which ITA is linked at a level higher than 70% and that including GTR and MAT linked to the previous one at a level slightly superior to 50%. Also in this dendrogram LEL seems rather isolated being linked to the last group at a level of about 40%.

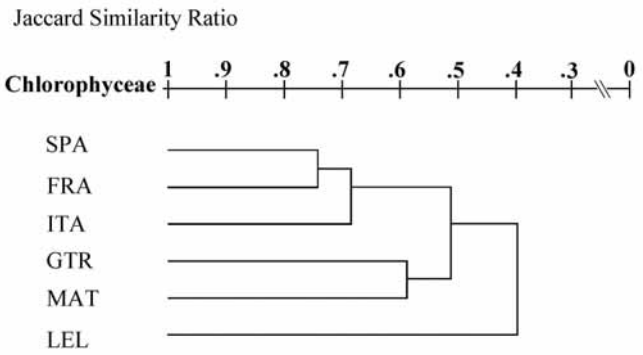

Fig. 6. Dendrogram depicting mutual floristic similarities of Chlorophyceae of the six floras investigated.

The dendrogram of Fucophyceae (Fig. 7) shows a lower floristic similarity among areas since only the group SPA and FRA can be identified linked at a level lower than 70%. To this group is linked ITA at a level lower than 60%. As in previous dendrograms LEL is the area with the lowest value of linkage (about 30%). The discontinuity showed in the above three dendrograms by LEL area, due to the low number of species in each systematic group, could depend besides on the insufficient floristic knowledge of that area, also on both geomorphologic

characteristics of its coast (with rather reduced traits of rocky shores) and paleoclimatic events like sapropel crises (Giaccone *et al.*, 1997). In order to understand the phytogeographic characteristics of different areas, following a specific investigation of the areals of every species, the chorological spectrum of Ceramiales (Table 5 and Fig. 8), Fucophyceae (Table 6 and Fig. 9) and

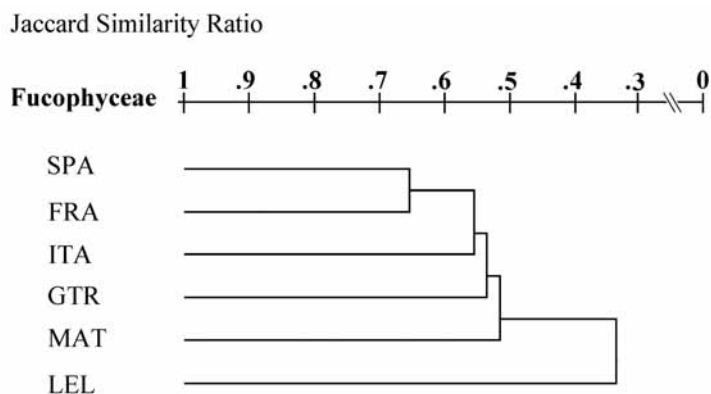

Fig. 7. Dendrogram depicting mutual floristic similarities of Fucophyceae of the six floras investigated.

Table 5. Chorological spectra of Ceramiales of the Mediterranean Sea and of each Mediterranean flora investigated.

Distribution groups	Mediterranean Sea	ITA	SPA	FRA	GTR	LEL	MAT
Atlantic	125 48.1%	105 48.8%	101 49.2%	103 48.1%	94 53.7%	69 53.9%	86 49.4%
Cosmopolitan	31 11.9%	26 12.0%	27 13.1%	29 13.5%	25 14.2%	24 18.7%	25 14.3%
Circumboreal	1 0.3%	1 0.4%	0 0%	1 0.4%	1 0.5%	0 0%	1 0.5%
Indo-Pacific	15 5.7%	12 5.5%	8 3.9%	12 5.6%	8 4.5%	7 5.4%	7 4.0%
Mediterranean	80 30.7%	65 30.2%	61 29.7%	61 28.5%	39 22.2%	21 16.4%	49 28.1%
Circumtropical	8 3.0%	6 2.7%	8 3.9%	8 3.7%	8 4.5%	7 5.4%	6 3.4%

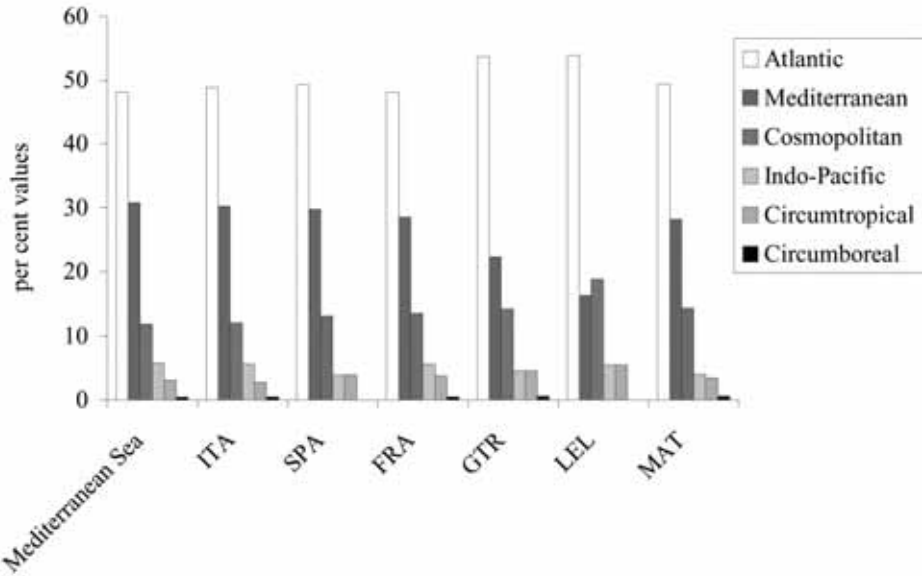

Fig. 8. Histogram showing the percentages of Ceramiales of the six floras investigated belonging to each distribution group.

Table 6. Chorological spectra of Fucophyceae of the Mediterranean Sea and of each Mediterranean flora investigated.

Distribution groups	Mediterranean Sea	ITA	SPA	FRA	GTR	LEL	MAT
Atlantic	102 41.9%	79 38.5%	53 39.5%	57 36.3%	42 35.0%	20 27.0%	48 40.3%
Cosmopolitan	35 14.4%	35 17.0%	33 24.6%	31 19.7%	30 25.0%	26 35.1%	30 25.2%
Circumboreal	5 2.0%	4 1.9%	4 2.9%	5 3.1%	3 2.5%	1 1.3%	2 1.6%
Indo-Pacific	13 5.3%	8 3.9%	4 2.9%	9 5.7%	4 3.3%	5 6.7%	5 4.2%
Mediterranean	83 34.1%	74 36.0%	37 27.6%	52 33.1%	38 31.6%	18 24.3%	31 26.0%
Circumtropical	5 2.0%	5 2.4%	3 2.2%	3 1.9%	3 2.5%	4 5.4%	3 2.5%

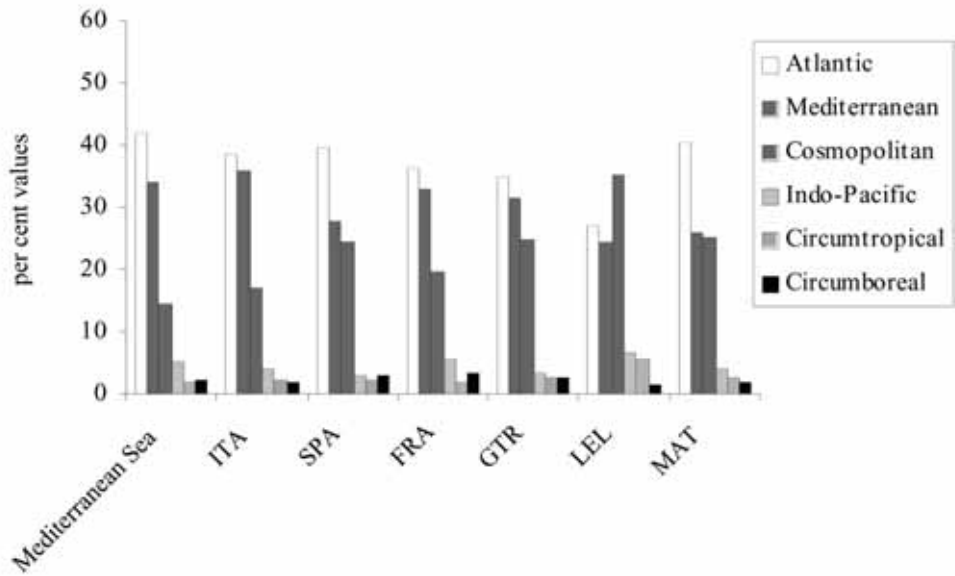

Fig. 9. Histogram showing the percentages of Fucopeyceae of the six floras investigated belonging to each distribution group.

Chlorophyceae (Table 7 and Fig. 10) of each area was calculated. On this basis, the phytogeographic similarity among different areas has been established and a hierarchical clustering has been carried out using the same methodology as for phytogeographic comparisons within the Italian flora. In the dendrogram of Ceramiales (Fig. 11), the following groups can be identified: SPA-MAT and ITA-FRA linked at a level higher than 90% and GTR-LEL linked to the first two groups at a value higher than 80%. Such a dendrogram is very similar to that of Fucopeyceae (Fig. 12) in which the following groups can be detected: SPA-MAT at a level of importance of about 95% to which GTR is linked at a level of about 93% and ITA-FRA at a level of about 93% linked to the previous group at about 90%. The LEL area is linked to both the previous groups at a level of about 75%. In the dendrogram of Chlorophyceae (Fig. 13) areas are always linked at high level of importance (the lowest value is higher than 80%), but the resulting groups (ITA and SPA with FRA linked at a level of importance higher than 95%; GTR and MAT linked to the previous group at a level of about 90% and LEL linked to the previous groups at a level of about 85%) are different from those identifiable in the previous dendrogram.

Table 7. Chorological spectra of Chlorophyceae of the Mediterranean Sea and of each Mediterranean flora investigated.

Distribution groups	Mediterranean Sea	ITA	SPA	FRA	GTR	LEL	MAT
Atlantic	79 44.3%	68 44.1%	53 44.1%	52 42.6%	40 42.1%	25 34.7%	36 40.0%
Cosmopolitan	42 23.5%	42 27.2%	33 27.5%	35 28.6%	32 33.6%	22 30.5%	29 32.2%
Circumboreal	2 1.1%	1 0.6%	1 0.8%	2 1.6%	2 2.1%	1 1.3%	1 1.1%
Indo-Pacific	12 6.7%	7 4.5%	7 5.8%	4 3.2%	4 4.2%	8 11.1%	5 5.5%
Mediterranean	29 16.2%	24 15.5%	17 14.1%	20 16.3%	9 9.4%	7 9.7%	9 10.0%
Circumtropical	14 7.8%	12 7.7%	9 7.5%	9 7.3%	8 8.4%	9 12.5%	10 11.1%

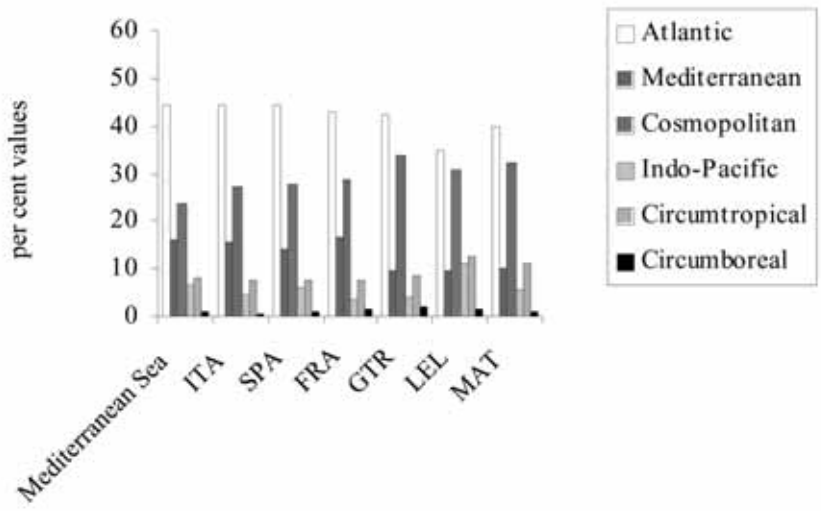

Fig. 10. Histogram showing the percentages of Chlorophyceae of the six floras investigated belonging to each distribution group.

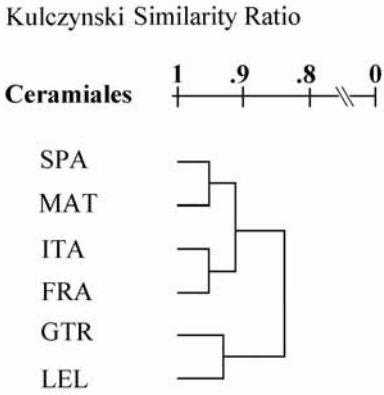

Fig. 11. Dendrogram depicting mutual chorological similarities of Ceramiales of the six floras investigated.

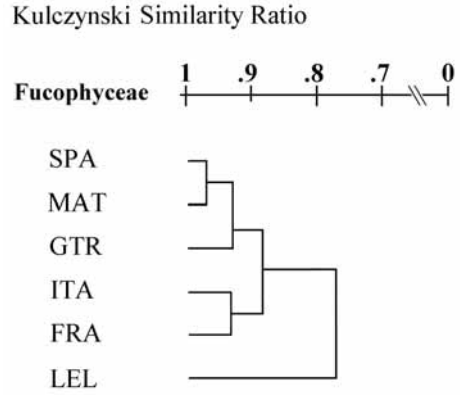

Fig. 12. Dendrogram depicting mutual chorological similarities of Fucophyceae of the six floras investigated.

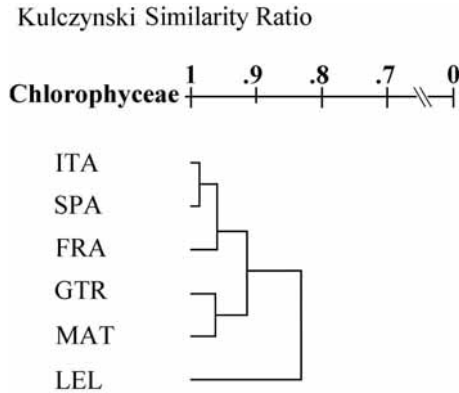

Fig. 13. Dendrogram depicting mutual chorological similarities of Chlorophyceae of the six floras investigated.

From the above comparisons it resulted that from a phytogeographic point of view the Mediterranean areas here considered have a higher degree of similarity than that shown from a floristic point of view. No marked discontinuities, at least at large scale, resulted even though in limited areas chorological spectra can show peculiar characteristics [e.g. the Straits of Messina with marked Atlantic characteristics (Giaccone & Rizzi Longo 1976); the banks of the Straits of Sicily with marked Mediterranean characteristics (Cinelli 1981), etc.].

In conclusion, from this study it resulted a noticeable similarity among the six Mediterranean areas here considered from both floristic and phytogeographic point of views with the only exception, as above mentioned, of the LEL area. Moreover, it should be pointed out that the benthic macroalgal flora of Italy is the richest in species. That is due, besides the high number of phycological studies carried out along its coasts (especially in the last years), also because Italy has a noticeable extension of rocky shores that are, moreover, washed by three seas: Tyrrhenian, Ionian and Adriatic.

Finally, it should be pointed out that, even though algal lists taken into consideration are based on references since 1950 in order to represent as well as possible the present composition, for some areas they can be already considered as "historical". In fact, very recent studies have shown noticeable changes in the floristic composition in some areas occurred in the last decades : for example, at the Tremiti Islands (Adriatic Sea, Italy), from a floristic study carried out in the year 1997 and published in 2000 (Cormaci *et al.* 2000) it resulted that of 275 species reported in literature between the late '60s and early '70s, 108 species (about 40% of that flora) were not found. Conversely, 153 species (about 47% of the present flora) were newly reported.

At Maddalena Peninsula (near Syracuse, Italy), from a study by Marino *et al.* (1999) it resulted that of 305 macroalgal species reported in literature up to 1980, 70 species (about 23% of that flora) were not found. Conversely, 164 species (about 41% of the present flora) were newly reported.

At the Ciclopi Islands (near Catania, Italy), from an unpublished study carried out in the year 2000 (Serio, personal communication), it resulted that of 364 species reported in literature between 1969 and 1989, 135 species (37% of that flora) were not found while 46 species (about 17% of the present flora) were newly reported. It is probable that similar changes, that are verifying in different areas of the Mediterranean Sea, are due to different factors like the increasing of the average temperature of the seawater, the increasing of discharge of both chemical pollutant and/or of inert material causing a noticeable increasing of water turbidity, etc.

Therefore, the drawing of checklists, like those of Fucophyceae, Chlorophyceae, Ceramiales of the Mediterranean Sea, and/or floras, like that of Italy here discussed, assume, in our opinion, a particular value. In fact, on one hand they testify which species were present in a certain historical period in different areas of the Mediterranean Sea, on the other they represent a starting point letting to check possible changes as they happen.

Note

Paper and annexes updated from the original reprint:

Furnari G., Giaccone G. & Cormaci M. (2003) – The benthic macroalgal flora of Italy: Floristic and geobotanic considerations. *Bocconea* 16(1): 225-243.

REFERENCES

- Agardh C. A. (1822-1823) - *Species algarum*. vol. 1 part 2. Lund.
- Agardh C. A. (1828) - *Species algarum*. vol. 2. Lund
- Agardh J. G. (1842) - *Algae maris mediterranei et adriatici*. - Ed. Masson, Paris.
- Agardh J. G. (1851-1863) - *Species genera et ordines algarum*. Volumen secundum: algas Florideas complectens. - Pars prior (1851) 1-336 + I-XII; Pars secunda (1852) 337-786; Pars tertia (1863) 787-1291 (pp 1139-1158 omitted). Lundae [Lund].
- Alongi G., Pizzuto F., Scammacca B. & Giaccone G. (1993) - La flora sommersa dell'isola di Vulcano (Isole Eolie). *Boll. Acc. Gioenia Sc. Nat. Catania*, 26: 273-291.
- Ardissone F. (1883) - *Phycologia Mediterranea*. Parte prima. Floridee. - Mem. Soc. Crittog. Ital. 1: X + 516 pp.
- Ardissone F. (1886-1887) - *Phycologia Mediterranea*. Parte seconda. Oosporee-Zoosporee-Schizosporee. *Memorie della Società Crittogamologica Italiana*, 2: 1-128 (1886), 129-325 (1887).
- Battiato A., Duro A. & Galluzzo G. (1978) - Flora sommersa della Baia di Brucoli (Siracusa). Secondo contributo con osservazioni preliminari sui Briozoi. *Boll. Acc. Gioenia Sc. Nat. Catania*, 13: 105-117.
- Battiato A. & Ponte A. (1975) - Flora sommersa della Baia di Brucoli (Siracusa). Primo contributo. *Atti Acc. Gioenia Sc. Nat. Catania*, 7: 93-99.
- Battiato A. & Ponte A. (1978) - Osservazioni preliminari sulla flora algale di Pozzillo (Sicilia orientale). *Boll. Acc. Gioenia Sc. Nat. Catania*, 13: 71-80.
- Benedetti Cecchi L. & Cinelli F. (1992) - Canopy removal experiments in *Cystoseira*-dominated rockpools from the Western coast of the Mediterranean (Ligurian Sea). *J. Exp. Mar. Biol. Ecol.*, 155: 69-83.
- Berthold G. (1884) - Die Cryptonemiaceen des golfes von Neapel. *Fauna und Flora des golfes von Neapel* 12. Lipsia.
- Borzi A. (1886) - *Nuove Floridee Mediterranee*. *Notarisia*, 1: 70-72.
- Boudouresque Ch. F. (1973) - Recherches de bionomie analytique, structurale et expérimentale sur les peuplements benthiques sciaphiles de Méditerranée occidentale (fraction algale). Les peuplements sciaphiles de mode relativement calme sur substrats durs. *Bull. Mus. Hist. Nat. Marseille*, 33: 147-225.
- Boudouresque Ch. F. & Cinelli F. (1971) - Le peuplement algal des biotopes sciaphiles superficiels de mode battu de l'île d'Ischia (Golfe de Naples, Italie). *Pubbl. Staz. Zool. Napoli*, 39: 1-43.
- Cavaliere A. (1957) - Algologia dello stretto di Messina. Nota preliminare. *Boll. Pesca Piscic. Idrobiol.*, 11: 281-282.
- Cavaliere A. (1959) - Ricerche sulla flora algologica dello stretto di Messina. I contributo. *Boll. Ist. Bot. Univ. Catania*, ser. II, 1: 155-179.
- Cavaliere A. (1960) - Ricerche sulla flora algologica dello stretto di Messina. II contributo. *Boll. Ist. Bot. Univ. Catania*, ser. II, 3: 78-88.
- Cecere E., Cormaci M. & Furnari G. (1991) - The marine Algae of Mar Piccolo, Taranto (Southern Italy): A re-assessment. *Botanica Marina*, 34: 221-228.
- Cecere E., Cormaci M., Furnari G., Petrocelli A., Saracino O. & Serio D. (1996) - Benthic algal flora of Cheradi islands (Gulf of Taranto, Mediterranean Sea). *Nova Hedwigia*, 62: 191-214.

Cinelli F. (1969) - Primo contributo alla conoscenza della vegetazione algale bentonica del litorale di Livorno. *Pubbl. Staz. Zool. Napoli*, 37: 545-566.

Cinelli F. (1971) - Biologia delle secche della Meloria (Mar Tirreno) IV. Contributo alla conoscenza della vegetazione bentonica marina. *Boll. Pesca Piscic. Idrobiol.*, 26: 5-20.

Cinelli F. (1971b) - Alghe di profondità raccolte alla Punta S. Pancrazio nell'isola di Ischia (Golfo di Napoli). *Giorn. Bot. Ital.*, 105: 207-236.

Cinelli F. (1981) - Biogeography and ecology of the Sicily channel. I. The algae of the banks. - Pp: 234-240 in: Levring, T. (ed.), *Xth International Seaweed Symposium*. Walter de Gruyter and Co. Berlin.

Cinelli F., Drago D., Furnari G., Giaccone G., Scammacca B., Solazzi A., Sortino M. & Tolomio C. (1976) - Flora marina dell'isola di Linosa (Arcipelago delle Pelagie). *Mem. Biol. Mar. Ocean.*, 6: 141-172.

Codomier L. & Giaccone G. (1972) - Sur quelques algues du Déroit de Messine et des environs de la Sicile. *Giorn. Bot. Ital.*, 106: 339-349.

Cormaci M., Duro A. & Furnari G. (1982) - Considerazioni sugli elementi fitogeografici della flora algale della Sicilia. *Atti 13° Congresso SIBM. Il Naturalista Siciliano 6 (Suppl.)*: 7-14.

Cormaci, M., & Furnari, G. (1979) - Flora algale della penisola della Maddalena (Siracusa). *Thalassia Salentina*, 9: 3-18.

Cormaci M., & Furnari G. (1979b) - Flora algale marina della Sicilia orientale: "Rhodophyceae, Phaeophyceae e Chlorophyceae". *Inform. Bot. Ital.*, 11: 221-250.

Cormaci M., Furnari G., Alongi G., Catra M., Serio D. (2000) - The benthic algal flora on rocky substrata of the Tremiti Islands (Adriatic Sea). - *Plant Biosystems*, 134: 133-152.

Cormaci M., Furnari G. & Scammacca B. (1976) - Su alcune specie interessanti della flora algale della Sicilia orientale. *Boll. Pesca Piscic. Idrobiol.*, 31: 177-186.

Cormaci M., Furnari G. & Scammacca B. (1978) - Ricerche floristiche sulle alghe marine della Sicilia orientale. *Terzo Contributo. Boll. Acc. Gioenia Sc. Nat. Catania*, 13: 27-44.

Cormaci M., Furnari G., Scammacca B., Serio D., Pizzuto F., Alongi G., & Dinaro R. (1992) - La vegetazione marina di substrato duro dell'isola di Salina (Isole Eolie). *Boll. Acc. Gioenia Sc. Nat. Catania*, 25: 115-144.

Cossu A. Gazale V. & Baroli M. (1992) - La flora marina della Sardegna: inventario delle alghe bentoniche. *Giorn. Bot. Ital.*, 126: 651-707.

Delle Chiaje S. (1829) - *Hydrophytologia Regni Neapolitani*. Neapoli.

De Toni G. B. (1889) - *Sylloge Algarum omnium hucusque cognitarum*. Vol. I. Chlorophyceae. Sectio I-II. - Patavii: cxxxix + 1315 pp.

De Toni G. B. (1895) - *Sylloge Algarum omnium hucusque cognitarum*. Vol. III. Fucoideae. - Patavii III: xvi + 638 pp.

De Toni G. B. (1897) - *Sylloge Algarum omnium hucusque cognitarum*. Vol. IV. Florideae, Sectio I. - Patavii IV: i-lxi + 388 pp.

De Toni G. B. (1900) - *Sylloge Algarum omnium hucusque cognitarum*. Vol. IV. Florideae, Sectio II. - Patavii IV: 387-776.

De Toni G. B. (1903) - *Sylloge Algarum omnium hucusque cognitarum*. Vol. IV. Florideae, Sectio III. - Patavii IV: 775-1525.

- De Toni G. B. (1905) - Sylloge Algarum omnium hucusque cognitarum. Vol. IV. Florideae. Sectio IV. - Patavii IV: 1523-1973.
- De Toni G. B. (1924) - Sylloge Algarum omnium hucusque cognitarum. Vol. VI. Florideae, Sectio V, Additamenta. - Patavii VI: xi + 767 pp.
- De Toni G. B. & Levi D. (1885) - Flora algologica della Venezia. Parte prima. Le Floridee. - Tip. Antonelli, Venezia.
- De Toni G. B. & Levi D. (1886) - Flora algologica della Venezia. Parte seconda. Le Melanoficee - Tip. Antonelli, Venezia.
- De Toni G. B. & Levi D. (1888) - Flora algologica della Venezia. Parte terza. Le Cloroficee. - Tip. Antonelli, Venezia.
- Falkenberg P. (1879) - Die Meeres-Algen des Golfes von Neapel. Nach beobachtungen in der Zool. Station während der Jahre 1877-78 zusammengestellt. - Mitteilungen der Zoologischen Station zu Neapel, 1: 218-277.
- Falkenberg P. (1901) - Die Rhodomelaceen des Golfes von Neapel und der angrenzenden Meeresabschnitte. - Fauna und Flora des Golfes von Neapel, Monographie 26. Berlin.
- Funk G. (1927) - Die Algenvegetation des Golfs von Neapel. Pubbl. Staz. Zool. Napoli, 7 (suppl.).
- Funk G. (1955) - Beitrage zur kenntnis der Meeresalgen von Neapel. Pubbl. Staz. Zool. Napoli, 25 (suppl.).
- Furnari G., Cormaci M. & Serio D. (1999) - Catalogue of the benthic marine macroalgae of the Italian coast of the Adriatic Sea. *Bocconea*, 12: 5-214.
- Furnari G., Giaccone G., Cormaci M., Alongi G. & Serio D. (2003) - Biodiversità marina delle coste italiane: catalogo del macrofitobenthos. *Biol. Mar. Medit.*, 10 (1): 3-483.
- Furnari G. & Scammacca B. (1970a) - Ricerche floristiche sulle alghe marine della Sicilia orientale. *Boll. Acc. Gioenia Sc. Nat. Catania*, 10: 215-230.
- Furnari G. & Scammacca B. (1970b) - Flora algale dell'isola Lachea (Golfo di Catania) *Giorn. Bot. Ital.*, 104: 137-164.
- Furnari G. & Scammacca B. (1971) - Nuovi ed interessanti ritrovamenti algologici nel litorale della Sicilia orientale. *Boll. Acc. Gioenia Sc. Nat. Catania*, 10: 656-662.
- Furnari G. & Scammacca B. (1973) - Ricerche floristiche sulle alghe marine della Sicilia orientale. *Nuovo contributo. Boll. Acc. Gioenia Sc. Nat. Catania*, 11: 1-22.
- Gallardo T., Gómez Garreta A., Ribera, M. A., Cormaci M., Furnari G., Giaccone G. & Boudouresque C. F. (1993) - Check-list of Mediterranean Seaweeds. II. Chlorophyceae Wille s. l. *Bot. Mar.*, 36: 399-421.
- Gargiulo G.M., De Masi F. & Tripodi G. (1985) - A study on *Gracilaria dendroides* sp. nov. (Gigartinales, Rhodophyta) from the Bay of Naples. *Br. Phycol. J.*, 20 : 357-364.
- Giaccone G. (1965) - Le fitocenosi marine nel settore rosso di Capo Zafferano (Palermo). *Lav. Ist. Bot. Giard. Col. Palermo*, 22: 3-34.
- Giaccone G. (1971) - Contributo allo studio dei popolamenti algali del basso Tirreno. *Ann. Univ. Ferrara, sez. IV Botanica*, 4: 17-43.
- Giaccone G. (1978) - Revisione della flora marina del mare Adriatico. - *Annuario del WWF. Parco Marino di Miramare Trieste*, 6: 5-118.

Giaccone G., Alessi M.C. & Toccaceli M. (1985) - Flora e vegetazione marina dell'Isola di Ustica. Boll. Acc. Gioenia Sc. Nat. Catania, 18: 505-536.

Giaccone G., De Leo A. (1966) - Flora e vegetazione algale del golfo di Palermo. Il contributo. Lav. Ist. Bot. Giard. Col. Palermo, 22: 1-69.

Giaccone G. & Di Martino, V. (1997) - Syntaxonomic relationship of the mediterranean phytobenthos assemblages: paleoclimatic bases and evolutive tendencies. Lagascalia, 19: 129-144.

Giaccone G. & Rizzi Longo L. (1976) - Revisione della flora dello Stretto di Messina (note storiche, bionomiche e corologiche). Mem. Biol. Mar. Ocean., 6: 69-123.

Giaccone G., Scammacca B., Cinelli F., Sartoni G. & Furnari G. (1972) - Studio preliminare sulla tipologia della vegetazione sommersa del canale di Sicilia e isole vicine. Giorn. Bot. Ital., 106: 211-229.

Giaccone G. & Sortino M. (1964) - Flora e vegetazione algale dell'isola delle Femmine. Lav. Ist. Bot. Giard. Col. Palermo, 21: 1-25.

Giaccone G. & Sortino M. (1974) - Zonazione della vegetazione marina delle isole Egadi. Lav. Ist. Bot. Giard. Col. Palermo, 25: 166-183.

Giaccone G., Sortino M. Solazzi A. & Tolomio C. (1973) - Tipologia e distribuzione estiva della vegetazione sommersa dell'isola di Pantelleria. Lav. Ist. Bot. Giard. Col. Palermo, 25: 103-119.

Gómez Garreta A., Gallardo T., Ribera M.A., Cormaci M., Furnari G., Giaccone G. & Boudouresque Ch.F. (2001) - Check-list of Mediterranean Seaweeds III. Rhodophyceae Rabenhorst. 1. Ceramiales Oltmanns. Botanica Marina, 44: 425-460.

Hauck F. (1882-1885) - Die meeresalgen Deutschlands und Oesterreichs. – In: Dr. L. Rabenhorst's Kryptogamen-Flora von Deutschland, Oesterreich und der Schweiz. Zweite Auflage. 2. Pp. 1-112 (1882); pp. 113-320 (1883); pp. 321-512 (1884); pp. 513-575 (1885). Leipzig.

Jaccard P. (1932) - Die statistische-floristische Methoden als Grundlage der Pflanzensoziologie. In: Abderhalden E., Handbuch der biologischen Arbeitsmethoden, 11(5): 165-202.

Kulczynski S. (1927) - Die Pflanzenassoziationen der Pieninen. Bull. intern. Acad. Polon. Sci. Lett. Cl. Sci math. et nat. sér. B. Sci Nat., suppl., 2: 57-203.

Kützing F. T. (1849) - Species algarum. Lipsiae. VI+922 pp.

Kützing F. T. (1854) - Tabulae phycologicae oder Abbildungen der Tange. Vol. 4 - Nordhausen.

Kützing F. T. (1855) - Tabulae phycologicae oder Abbildungen der Tange. Vol. 5 - Nordhausen.

Kützing F. T. (1856) - Tabulae phycologicae oder Abbildungen der Tange. Vol. 6 – Nordhausen

Kützing F. T. (1858) - Tabulae phycologicae oder Abbildungen der Tange. Vol. 8 - Nordhausen.

Kützing, F. T. (1860) - Tabulae phycologicae oder Abbildungen der Tange. Vol. 10 - Nordhausen.

Kützing F. T. (1862) - Tabulae phycologicae oder Abbildungen der Tange. Vol. 12 - Nordhausen.

Kützing F. T. (1863) - Tabulae phycologicae oder Abbildungen der Tange. Vol. 13 - Nordhausen.

Kützing, F. T. (1864) - Tabulae phycologicae oder Abbildungen der Tange. Vol. 14 - Nordhausen.

Kützing F. T. (1865) - Tabulae phycologicae oder Abbildungen der Tange. Vol. 15 - Nordhausen.

Kützing F. T. (1866) - Tabulae phycologicae oder Abbildungen der Tange. Vol. 16 - Nordhausen.

Kützing, F. T. (1869) - Tabulae phycologicae oder Abbildungen der Tange. Vol. 19 - Nordhausen.

- Langenbach G. (1873) - Die Meeresalgen der Inseln Sizilien und Pantelleria. Berlin.
- Levring T. (1942) - Meeresalgen aus dem Adriatischen Meer, Sizilien und dem Golf von Neapel. Kungl. Fysiogr. Soellsk. Foerhandl., 12: 25-41.
- Marino G., Di Martino V. & Giaccone G. (1999) - Diversità della flora della Penisola Maddalena (Siracusa, Sicilia S-E): cambiamento ventennale ed evoluzione. Boll. Accad. Gioenia Sci. Nat., Catania, 31: 289-315.
- Mazza A. (1902) - Flora marina del Golfo di Napoli. Contribuzione I. Nuova Notarisa, 13: 125-152.
- Meneghini G. (1842) - Alghe Italiane e Dalmatiche. - Padova 1842 Fasc. I: 1-80. Fasc. II: 81-160. Fasc. III: 161-255.
- Meneghini G. (1843) - Alghe Italiane e Dalmatiche. - Padova 1843 Fasc. IV: 257-352.
- Meneghini G. (1846) - Alghe Italiane e Dalmatiche. - Padova 1846 Fasc. V: 353-385.
- Molinier R. & Picard J. (1953) - Notes biologiques à propos d'un voyage d'étude sur les côtes de Sicile. Ann. Inst. Océanogr. 28: 163-188.
- Naccari F.L. (1828) - Algologia Adriatica. Stamperia Cardinali e Friuli, Bologna: 157 pp.
- Papi I., Pardi G., Lenzini S., Benedetti Cecchi L. & Cinelli, F. (1992) - Benthic marine flora in the Tuscan Archipelago. A first contribution: Isles of Capraia, Elba, Formiche di Grosseto, Giglio, Scoglio d'Africa, Montecristo and Giannutri. Giorn. Bot. Ital., 127: 797-819.
- Philippi P. (1837) - Sulle coralline di Sicilia osservate durante gli anni 1830-1832.
- Piccone A. (1889) - Noterelle ficologiche. Notarisa, 4: 664-671.
- Pignatti S. (1962) - Associazioni di alghe marine sulla costa Veneziana. - Mem. Ist. Veneto Sci., Lett. Arti, Cl. Sci. Mat. Nat., 32: 1-134.
- Pignatti S. & Rizzi L. (1972) - Raccolte di alghe bentoniche nelle acque dell'Arcipelago Toscano. Atti Ist. Veneto Sci., Lett. ed Arti Cl. Sci. Mat. e Nat. Venezia, 130: 313-327.
- Reinke J. (1878) - Entwicklungsgeschichtliche Untersuchungen über die Cutleriaceen des Golfs von Neapel. Nova Acta Ac. Caes. Leop. Car. XL. Dresden.
- Ribera M.A., Gomez Garreta A., Gallardo T., Cormaci M., Furnari G. & Giaccone G. (1992) - Check-list of Mediterranean Seaweeds. I. Fucophyceae (Warming, 1884). Botanica Marina, 35: 109-130.
- Scammacca B., Giaccone G., Pizzuto F. & Alongi G. (1993) - La vegetazione marina di substrato duro dell'isola di Lampedusa (Isole Pelagie). Boll. Acc. Gioenia Sc. Nat. Catania, 26: 85-126.
- Schiffner V. (1914) - Ueber einige neue und interessante algen aus der Adria. - Nuova Notarisa, 25: 181-183.
- Schiffner V. (1916) - Studien über algen des Adriatischen meers. - Wiss. Meeresuntersuch., Abt. Helgoland., 11: 129-198.
- Schiffner V. (1926) - Beiträge zur Kenntnis der Meeresalgen. III. Einige algen von Riccione bei Rimini. - Hedwigia, 66: 311-312.
- Schiffner V. (1926) - Beiträge zur Kenntnis der Meeresalgen. IV. Über einige Algen der Adria und von Helgoland. - Hedwigia, 66: 312-318.
- Schiffner V. & Vatova A. (1937) - Le Alghe della Laguna di Venezia. - Estratto dalla Monografia: La Laguna di Venezia, vol. III, parte V, Tomo IX: 174pp. + 57 tavv. - Officine Grafiche Ferrari, Venezia.
- Sokal R.R. & Sneath P.H.A. (1963) - Principles of numerical taxonomy. London

- Solazzi A. (1965 (1964) - Primi dati sulle alghe della scogliera "I travi" di Portonovo (Ancona). - *Giorn. Bot. Ital.*, 71: 253-257.
- Solazzi A. (1967) - Studio ecologico sulla vegetazione algale bentonica (macrofite) della riviera del Monte Conero. - *Mem. Biogeogr. Adriat.*, 7: 159-192.
- Solazzi A. (1969) - Su alcuni ritrovamenti interessanti di alghe in Puglia e in Sardegna. - *Giorn. Bot. Ital.*, 103: 163-167.
- Solazzi A. (1976) - Le alghe della costa Marchigiana. - *Giorn. Bot. Ital.*, 110: 419-425.
- Solms-Laubach H. (1881) - Die Corallinalgen des Golfes von Neapel und der angrenzenden Meeres-Abschnitte. - *Fauna und Flora des Golfes von Neapel, Mono-graphie 4.* Leipzig.
- Sortino M. (1967) - Flora e vegetazione terrestre e marina del litorale di Palma di Montechiaro (Agrigento). *Lav. Ist. Bot. Giard. Col. Palermo*, 23: 1-112.
- Sortino M. (1968) - Flora e vegetazione portuale della costa meridionale della Sicilia. I. Flora sommersa del porto di Licata (Agrigento). *Lav. Ist. Bot. Giard. Col., Palermo* 24: 1-20.
- Spinelli V. (1905) - Le alghe marine della Sicilia orientale. *Atti Accad. Gioenia Sc. Nat. Catania*, 18: 1-55.
- Tornabene F. (1846) - Saggio di geografia botanica per la Sicilia. *Atti VII Riun. Sc. It. in Napoli. Napoli.*
- Valiante R. (1883) - Le Cystoseirae del golfo di Napoli. *Fauna und Flora des Golfes von Neapel 7.* Lipsia.
- Zanardini G. (1841) - Synopsis algarum in Mari Adriatico hucusque Collectarum cui accedunt monographia siphonearum nec non generales de algarum vita et structura disquisitiones cum tabulis auctoris manu ad vivum depictis. - *Mem. Reale Accad. Sci. Torino ser. 2, 4:* 105-255.
- Zanardini, G. (1843) Saggio di classificazione naturale delle Ficee. Venezia. 64 pp.
- Zanardini G. (1847) - Notizie intorno alle cellulari marine delle lagune e de' litorali di Venezia. - *Atti Reale Ist. Veneto Sci., Lett. Arti. Ser. 1, 6:* 185-262.
- Zanardini G. (1858) - Catalogo delle piante crittogame raccolte finora nelle provincie venete. *Atti Reale Ist. Veneto Sci. Lett. Arti. Ser. 3, 3:* 205-300.
- Zanardini G. (1860) - *Iconographia Phycologica Adriatica ossia scelta di Ficee nuove o più rare del Mare Adriatico. Vol. I.* - Antonelli, Venezia.
- Zanardini G. (1865) - *Iconographia Phycologica Adriatica ossia scelta di Ficee nuove o più rare del Mare Adriatico: Vol. II.* - Antonelli, Venezia.
- Zanardini G. (1871) - *Iconographia Phycologica Adriatica ossia scelta di Ficee nuove o più rare del Mare Adriatico: Vol. III.* - Antonelli, Venezia.

SESSION «BIOLOGY, ECOLOGY AND
INVENTORIES OF SPECIES AND
ASSEMBLAGES»

*SESSION «BIOLOGIE, ECOLOGIE ET
INVENTAIRES DES ESPECES ET DES
FORMATIONS»*

NEW RECORDS ALONG THE APULIAN COASTS

Antonella BOTTALICO, Costanza Ilaria DELLE FOGLIE and Cesira PERRONE

Department of Biology and Plant Pathology, University of Bari Via E. Orabona 4, 70125 Bari, ITALY

ABSTRACT

The following new records from Apulia are reported: *Halarachnion ligulatum* (Gigartinales, Rhodophyta), *Gelidiella* sp. (Gelidiales, Rhodophyta) and *Batophora* sp. (Dasycladales, Chlorophyta). The first record extends the distribution area of *H. ligulatum* to the south of the Adriatic Sea, where it was only known from the Gulf of Trieste. The attribution of *Gelidiella* sp. to an undescribed taxon is supported by a long-term study. The occurrence of the tropical genus *Batophora*, previously recorded only from the Caribbean area and from the Canary Islands, is reported for the first time in the Mediterranean.

KEY WORDS: *Halarachnion*, *Gelidiella*, *Batophora*, Apulia, Mediterranean.

INTRODUCTION

During collection campaigns in some uninvestigated Apulian coastal areas (Adriatic and Ionian), aimed at enriching the seaweed collection of the Department of Biology and Plant Pathology (University of Bari, Italy), the following new records were found: *Halarachnion ligulatum* (Woodward) Kützing and two taxa belonging to *Gelidiella* Feldmann et Hamel and *Batophora* J. Agardh.

The finding of *H. ligulatum*, not reported in Apulia in the recent catalogue of macrophytobenthos of Italian coasts (Furnari *et al.*, 2003) represents the first record for this region and for the southern Adriatic Sea.

Along the same coast in 1999 Lapenna and Perrone reported an undescribed species presumably belonging to *Gelidiella*. All the Mediterranean representatives of the genus *Gelidiella* have been reported from Apulia, that is *G. antipae* Celan, *G. lubrica* (Kützing) Feldmann et Hamel, *G. nigrescens* (Feldmann) Feldmann et Hamel, *G. ramellosa* (Kützing) Feldmann et Hamel and *G. tenuissima* Feldmann et Hamel (Furnari *et al.*, 2003).

The genus *Batophora* is currently represented by two species, *B. oerstedii* J. Agardh and *B. occidentalis* (Harv.) S. Berger et Kaever ex M. J. Wynne. They live together in the Caribbean region and only recently they have also been reported in the central eastern Atlantic Ocean (Canary Islands) (Haroun *et al.*, 2002). Therefore our record is the first for the Mediterranean basin.

MATERIALS AND METHODS

Thalli were collected in the following sites: the southern littoral of Bari (Adriatic Sea, 41°6'58"N, 16°53'38"E) for *H. ligulatum*; a small marine cave, the Grotta della Regina at Torre a Mare, in the district of Bari (Adriatic Sea, 41°5'21"N, 16°59'38"E) for *Gelidiella* sp.; Torre Borraco (Taranto, Ionian Sea, 40°18'25"N, 17°40'3"E) for *Batophora* sp. Specimens are kept at the herbarium of the Department of Biology and Plant Pathology. Observations were made on freshly collected, formalin-preserved, lab-cultured material and on herbarium specimens.

Vegetative characteristics reliable for the diagnosis of the genus *Batophora* were observed on 50 thalli randomly collected in the field and compared with those of specimens of *B. oerstedii* and *B. occidentalis* obtained from Chetumal Bay (Mexico). Lab-cultures were performed in order to observe thallus morphogenesis and possibly to induce gametophore production. Substrates colonised by *Batophora* sp., collected in the field, were the culture material. Erd-Schreiber medium, changed weekly, was used. Germanium dioxide (6 ppm) was added to the medium in order to reduce diatom contamination. Tests were carried out in growth chambers under the following conditions: 90 $\mu\text{mol m}^{-2} \text{s}^{-1}$ PFD, 18° and 26° \pm 1°C, 12:12 or 16:8 light/dark regimes. Some Apulian thalli of *Batophora* sp. resembled *Dasycladus vermicularis* (Scopoli) Krasser so that a comparative study with the latter species was performed.

RESULTS

Thalli of *H. ligulatum* were collected for the first time in June 1998 (Fig. 1a) in shaded crevices, at 1-3 m depth. Apulian gametophytes have a small attachment disc, about 1 mm in diam., from which one to several flattened fronds arise. Plants are brownish red, up to 200 mm long and 5-20 mm broad. The stipe expands into irregularly branched blades, tapering at the ends, proliferating from both margins and surfaces. The cortex consists of 2-3 layers; the outer cortical cells are small and polygonal in surface view. The medulla ranges from rather compact to very loose and lacunose; it is obliquely crossed by few cylindrical filaments, about 8 μm in diameter, and by long arms of pseudostellate cells (Fig. 1b).

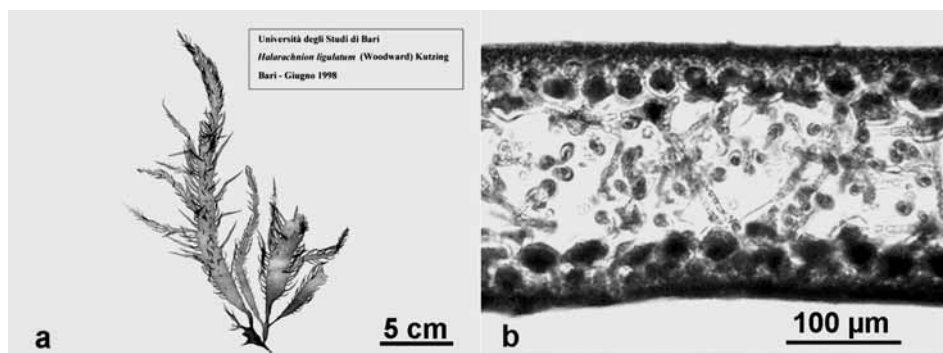

Fig. 1. *H. ligulatum*. (a) Habit of the herbarium specimen collected at Bari, Adriatic Sea; (b) cross section of a blade.

Spermatangia are grouped in superficial sori, with 1-4 mother cells produced by each cortical cell (Fig. 2a). Gonimoblasts develop inwards and are 100-250 μm in size; most cells become carposporangia, 15-20 μm in diam. (Fig. 2b). Tetrasporangial plants were never found in our collected samples.

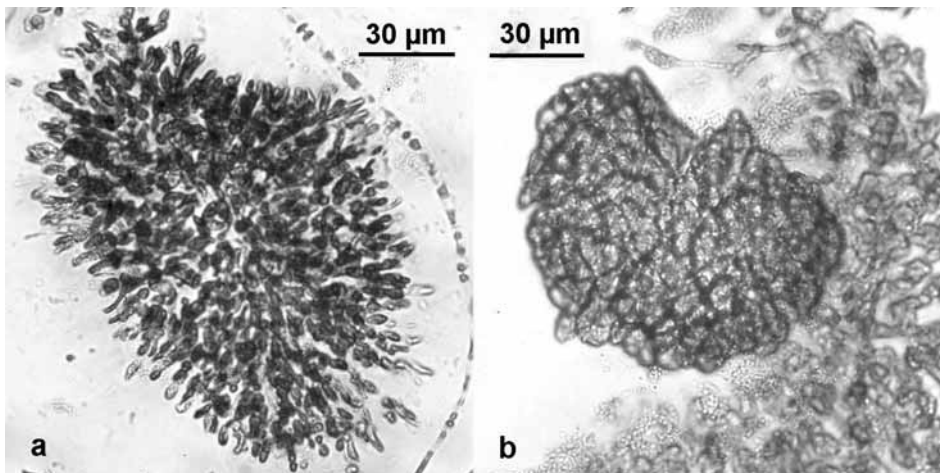

Fig. 2. *H. ligulatum*. (a) Spermatangial sorus; (b) carposporophyte.

Gelidiella sp. forms a thin dark red turf on very shaded rocks in the Grotta della Regina. The population always stays between +80 and +50 cm above sea level, never reached by high tide, but only by a rough sea. Plants consist of erect branches, up to 10 mm high, arising from long terete creeping axes (Fig. 3a). Erect axes are compressed at the distal part, max 140 μm wide. Most of them also bear rhizoids, so the whole plant assumes a creeping habit. The outer cortical cells are rectangular (6-7x10-12 μm) and horizontally arranged (Fig. 3b). Apical stichidia bearing a great number of tiers, up to 24, with 4 tetrasporangia per row, were found in spring-summer (Fig. 3c).

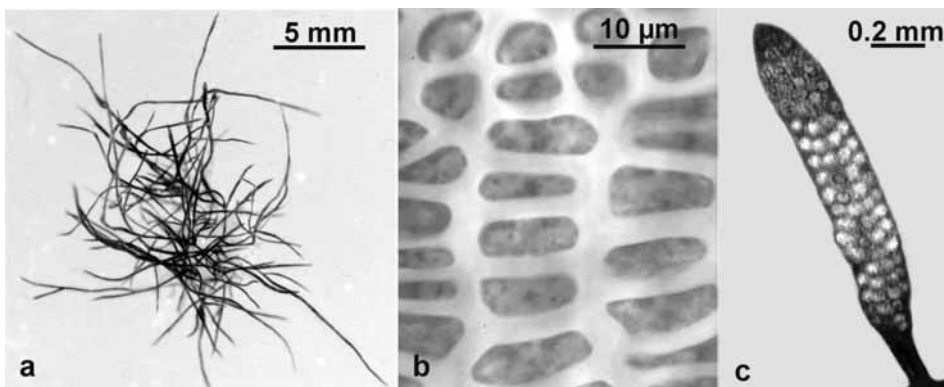

Fig. 3. *Gelidiella* sp. (a) Plants collected in the Grotta della Regina; (b) outer cortical cells in surface view; (c) tetrasporangial sorus (stichidium).

Mature tetrasporangia are spherical; tetrahedrally divided and measure 35-40 μm in diameter. In culture, tetrasporangia are soon released as a unit and numerous spores germinate. Germination follows the *Gelidium*-type pattern.

Thalli of the Apulian *Batophora* sp. colonise stones (Fig. 4a) at 0-3 m depth. Plants are bright green, soft and delicate. The thallus consists of a cylindrical stalk, sometimes branched (Fig. 4b), attached to the substrate by rhizoids, and numerous whorls of laterals. Reproductive organs were never observed on either field or lab-cultured thalli.

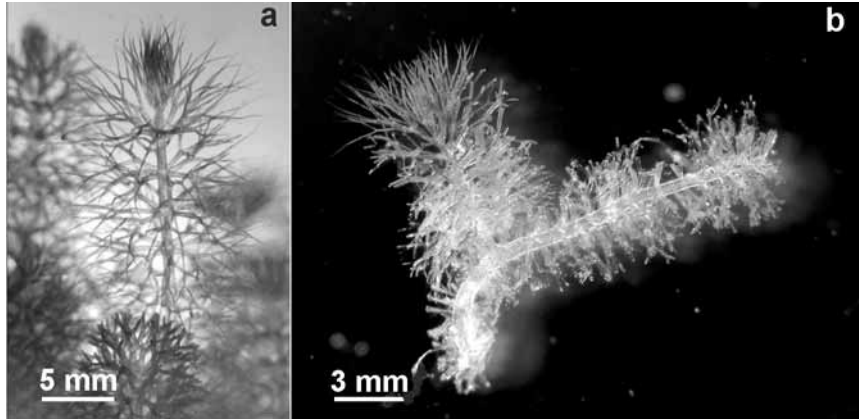

Fig. 4. *Batophora* sp. Detail of (a) an unbranched thallus; (b) a branched thallus.

Careful morphological and morphometric observations highlighted that the thalli of *Dasycladus* were smaller than those of *Batophora* and never branched; their main axis was 4-6 times wider and the first order laterals were shorter and more numerous (Fig. 5a, b).

In regard to diagnosis at species level, according to Berger and Kaefer (1992) in the genus *Batophora* the species are distinct on the basis of a few vegetative characters but above all on the basis of the reproductive ones. Comparison between Mexican and Apulian specimens pointed out some slight differences, probably due to the different geographical and climatic conditions (Table 6).

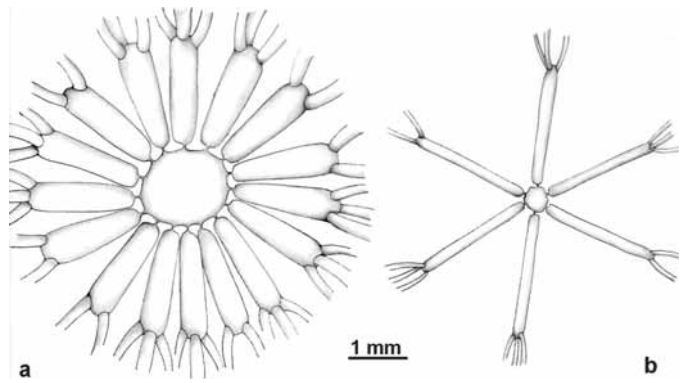

Fig. 5. *Batophora* sp. Scheme of a whorl in (a) *Dasycladus* and (b) *Batophora*.

Table 6 - Mean values of vegetative characteristics of *Batophora* sp. from Torre Borraco. Ranges reported for *B. occidentalis* and *B. oerstedii* by Berger and Kaever (1992), by Gomez-Poot et al. (2002) and for *Dasycladus vermicularis* from the Ionian Sea have been included for comparative purposes. Unavailable measurements are indicated with a dash.

	Apulian samples	Apulian samples	Berger & Kaever	Gomez-Poot et al.	Berger & Kaever	Gomez-Poot et al.
Height (cm)	2-6	5-6	2-4	3.7	4-14	3.9
Axis width (mm)	2-3	0.50	-	0.54	-	0.52
Width of the plant (mm)	5	3	2-4	4.31	6-13	4.58
Internodal distance (mm)	< 0.50	1	1.6	0.74	2.1	0.58
Branching order	3rd	4th-5th	5th-7th	-	5th-7th	-

DISCUSSION AND CONCLUSIONS

Gelidiella sp. is similar to the Mediterranean *G. tenuissima* and to the Atlantic *G. tinerfensis* Seoane-Camba in habit and habitat respectively. Compared to *G. tenuissima*, *Gelidiella* sp. has a larger thallus and different organisation of tetrasporangial sori. *G. tinerfensis* differs from *Gelidiella* sp. in that it bears more tetrasporangia per tier and their stichidia are very often branched. The peculiar characters observed in *Gelidiella* sp. such as shape and arrangement of outer cortical cells and number of tetrasporangia per tier are convincing enough to establish a new species.

The permanently sterile state of the Apulian *Batophora* sp. that has been monitored for three years created many diagnostic difficulties. The attribution of the Apulian dasycladalean plants to the genus *Batophora* is supported by distinct features. On the contrary, the attribution to a known species is not possible with certainty only on the basis of the vegetative characters, even though, according to Berger (*pers. comm.*); our specimens are more similar to *B. occidentalis*. At the moment it is difficult to advance any hypothesis on either the period or means of introduction of this tropical genus into the Mediterranean basin or on the sterility of our population.

ACKNOWLEDGEMENTS

We thank Dr. J. Espinoza-Avalos for providing liquid-preserved samples of *B. oerstedii* and *B. occidentalis* from Mexico, Dr. S. Berger for her useful suggestions and Prof. G. P. Felicini for help with photography.

REFERENCES

- Berger S., Kaefer M. J. (1992) - *Dasycladales. An illustrated monograph of a fascinating algal order.* Georg Thieme Verlag Stuttgart, New York: 247 pp.
- Furnari G., Giaccone G., Cormaci M., Alongi G., Serio D. (2003) - Biodiversità marina delle coste italiane: catalogo del macrofitobenthos. *Biol. Mar. Medit.*, 10 (1): 1-482.
- Gomez-Poot J. M., Espinoza-Avalos J., Jimenez-Flores S. G. (2002) - Vegetative and reproductive characteristics of two species of *Batophora* (Chlorophyta, Dasycladaceae) from Chetumal Bay, Quintana Roo, Mexico. *Bot. Mar.*, 45: 189-195.
- Haroun R. J., Gil-Rodríguez M. C., Díaz De Castro J., Prud'homme Van Reine W. F. (2002) - A Checklist of the marine plants from the Canary Islands (central eastern Atlantic Ocean). *Bot. Mar.*, 45 (2): 139-169.

THE SITUATION OF *CAULERPA* SPECIES AROUND TURKISH COASTS

Ş.ükran CIRIK and Baris AKÇALI

Çanakkale 18 Mart University Faculty of Fisheries Terzioğlu Campus 17100 Canakkale/TURKIYE
cirik@comu.edu.tr

ABSTRACT

This paper is about the studies which have been done to find out the distribution of *Caulerpa* species around Turkish Coasts (Aegean and Mediterranean). With this project it was targeted to monitor the invasion of the *Caulerpa* species existing in the Mediterranean coasts. During project, as well as Mediterranean endemic species such as *Caulerpa prolifera* and *Caulerpa ollivieri*, the Lessepsian species such as *Caulerpa racemosa* and its varieties (*Caulerpa racemosa* var. *occidentalis*, *Caulerpa racemosa* var. *lamourouxii* form. *requenii*), *Caulerpa scalpelliformis* were encountered.

KEYWORDS: Invasive, Lessepsian, *Caulerpa*, Mediterranean

INTRODUCTION

The Mediterranean Sea, where many civilisations evolved, is the most utilized and benefited sea by man. Coastal states of the Mediterranean Basin receive a share more than 70 % of the world tourism and have been bearing the most concentrated human population. Especially the Anatolia and its coasts, due to its climatic, geological and biogeographical conditions, show a continent characteristics and bears as many species as that may occur in a continent. Mediterranean Sea has a high biodiversity. A rough estimate of more than 8500 species of macroscopic marine organisms should live in the Mediterranean Sea, corresponding to somewhat between 4% and 18% of world marine species (Bianchi & Morri, 2000).

However, the list of exotic animals and plants that invaded the Mediterranean is getting longer everyday. Besides the afore-mentioned Lessepsian migrations, species are intentionally or accidentally introduced into the Mediterranean via ship fouling, ballast waters, aquaculture, trade of living bait, wrapping of fresh seafood with living algae, aquariology and even scientific research (Bianchi & Morri, 2000). The last threat, invasion of the exotic species –in this case lessepsian migratory species –, after the opening of the Channel has increasingly been observed along the Anatolian coasts. According to Boudouresque *et al.* (2002) there might be 85 introduced species in the Mediterranean.

At the Experts Working Group Meeting, organised by United Nations Environment Programme in 1998, it was concluded that both *Caulerpa racemosa*, one of the lessepsian species originated from tropical sea and *Caulerpa taxifolia*, originated during

aquariology studies in the western Mediterranean were affecting the ecosystem adversely. Moreover, it was also concluded that various studies on these species should be carried out and co-operation among the state countries should be supported. In addition, it was also recommended that the invasion of these species to be controlled and restrained by the Mediterranean coastal states. This is in accord with the international convention signed, by these studies in particular Biodiversity and Barcelona conventions.

As a consequence of the above mentioned reasons and developments, the Ministry of Environment started a project "Investigations on *Caulerpa* Species in the Mediterranean" to determine the status and carry out necessary studies.

With this project it was targeted to monitor the invasion of the *Caulerpa* species existing in the Mediterranean coasts (e.g. *Caulerpa taxifolia*). The occurrence of which has not been verified yet in our coasts and to develop preventions to stop possible invasions. Moreover, it was targeted to study the taxonomy and ecology of the *Caulerpa* species (e.g. *Caulerpa racemosa*), of which the presence of them were proved and invasive along Turkish coasts, to determine the effects of these invasive species on marine biodiversity, to monitor the invasion of them, and to develop precautions to halt further invasion of them.

In addition by taking into considerations the present infrastructure and activities, an "Action Plan" comprising the priority activities, has been developed to prepare appropriate actions and implementations in accordance with the international conventions on protection of biodiversity and exotic-invasive plants.

MATERIALS AND METHODS

The aim of the present study is to observe *Caulerpa* species around the Turkish coastal zone. Therefore, seasonal sampling has been done by using diving equipments and cameras. In addition, the horizontal and vertical distribution area of *Caulerpa racemosa* has been determined in Bodrum where the dense population of *Caulerpa racemosa* has been reported. By using a remotely operating vehicle (ROV), the deepest depth where *Caulerpa racemosa* distribute has been determined.

The project was started on September 2000. To fulfill the objectives of the project, coastline, where the possible *Caulerpa* distribution were already reported in the literature (Aleem, 1992; Panayotidis & Montesantou 1994; Cirik & Ozturk 1991), – totalling 5,000 km – between Enez town at the Turkish-Greek border and Samada town at the Turkish-Syrian Border was surveyed by means of SCUBA equipment, samples were collected, and these samples were identified under laboratory conditions. As a result of the first surveys, *Caulerpa taxifolia* was not encountered along the Turkish coasts. However, after the opening of the Suez Canal invasive Red Sea species *Caulerpa racemosa* was found present from south west Aegean to north Aegean, in particular, in the Gökova Bay and Bodrum Peninsula and its vicinity and confirmed by underwater footage.

The project activities were concentrated on education and awareness during winter and spring months, and meetings with broad participations were organised at the predetermined localities by *Caulerpa* working group in the Turkish Aegean and Mediterranean coasts. To these meetings relevant stakeholders including fishing co-operatives, diving clubs, harbour directorates, marina managers, coast guard and marine forces, town and provincial directorates of the Agriculture and Rural Affairs and Environment and academic institutions were participated. Brochures and questionnaire forms were distributed to these participants and inform these groups to target flow of feedback information from them.

Caulerpa (kaulos (Gr.) = thallus, stalk or stipe; herpo (gr.) = Creep). Green leafy algae from warm seas with creeping stolons that do not have internal divisions segregating the algae into individual cells. *Caulerpa* is divided into more than 72 highly variable species based on their morphology. Added to this are 56 varieties (Debelius & Baensch, 1997).

In Mediterranean Sea there are 6 *Caulerpa* species exists. Among these *Caulerpa prolifera* (Forsskål) Lamouroux and *Caulerpa ollivieri* Dostal were native and the others were exotic ones including *Caulerpa taxifolia* (Vahl) C. Agardh, *Caulerpa scalpelliformis* (Brown ex Turner), *Caulerpa mexicana* Sonder ex Kützing, *Caulerpa racemosa* (Forsskål) and its varieties (Boudouresque & Verlaque, 2002).

RESULTS AND CONCLUSION

Caulerpa racemosa, which entered to Mediterranean via opening of the Suez Channel and first encountered in the coasts of Tunis in 1926 by Hamel, shows various morphological characteristics in the places where exist and depending on ecological conditions. As a result of these, it is classified as different varieties by the taxonomists (Verlaque *et al.* 2000). Among these varieties *Caulerpa racemosa* var. *lamourouxii*; and *Caulerpa racemosa* var. *occidentalis* occurs along Turkish coasts.

During project, as well as Mediterranean endemic species such as *Caulerpa prolifera* and *Caulerpa ollivieri*, the lessepsian species such as *Caulerpa racemosa* and its varieties (*Caulerpa racemosa* var. *occidentalis*, *Caulerpa racemosa* var. *lamourouxii* form. *requenii*), *Caulerpa scalpelliformis* were encountered. (fig 1)

The *Caulerpa racemosa* species having alien-invasive behaviours, which grow extensively at the bays of Gökova and Güllük around Bodrum, continue their existence for all four seasons observed during the works of this project. (fig 1). The growth of this plant stops during the winter season and increases from the April onwards reaching the maximum stage during the August-September months.

Caulerpa racemosa was observed to grow intensively over the soft substrata of eutrophied zones consisting organic relicts, muddy-sandy biotopes or dead marine



◆ *Caulerpa racemosa* ● *Caulerpa scalpelliformis*

Fig. 1 : Distribution of *Caulerpa* species around Turkish coast.

meadows reefs. Plant has also been observed to grow very fast at the regions covered with dead leaves of *Posidonia* meadows. *Halophila stipulacea* which is a lessepsian flowered marine plant, forms a population with these plants especially at the shaded muddy-sandy biotope areas. Also the *Caulerpa prolifera* which is the indigenous Mediterranean species, were observed together with these two lessepsian species at the certain locations. *Cymodocea nodosa* and *Nana Zostera noltii* of marine meadows, and *Padina pavonica*, *Dictyota dichotoma*, *Jania rubens* and *Cystoseira crinita* of photophyllic algae grow together with *Caulerpa racemosa* at the shallow areas of all around Yalikavak.

Caulerpa racemosa was observed with mini Remote Operated Vehicle (ROV) down to 49 m water depths which are the deepest areas where *Caulerpa racemosa* could grow, to occupy at the sand-muddy sedimanter extensively grown grounds around the Yalikavak Bay. (fig. 1) *Caulerpa racemosa* was observed to grow every kind of habitat (rocky, sandy, muddy) through forming very firm and intensive texture horizontally. Especially calcareous corals (*Corallina* spp., *Jania* spp., *Amphiroa* spp., *Peyssonelia* spp., *Lithophyllum* spp., *Lithothamnion*, *Lithophyllum stictaeforme* etc.)

Caulerpa racemosa has taken the place of seagrass meadows (*Posidonia oceanica*) which have been disappearing slowly at the eutrophied zones in around Bodrum due to intensive coastal usage and marine activities *Caulerpa* species constitutes a serious threat for the Mediterranean marine biological, ecological and landscape diversity (Panayotidis & Zuljevic, 2000).

Caulerpa racemosa var. *lamourouxii* form. *requenii* which is an alien character Mediterranean lessepsian species, continues its existence mainly in the eastern Mediterranean at the certain localities. This species was described initially by P. HUVE at the Cousteau's research vessel Calypso at the southern Aegean. The same species was only observed during this project works at Kas (Üçadalar) and Tasucu areas locally. (fig.1).

REFERENCES

- Aleem A.A. (1992) - *Caulerpa racemosa* (Chlorophyta) on the Mediterranean coast of Egypt. Phycologia, 31: 205-206
- Bianchi C.N. and Morri C. (2000) - Marine biodiversity of the Mediterranean Sea: Situation, problems and prospects for future research. Mar. Poll. Bull., 40 (5) : 367-376
- Boudouresque C.F. and Verlaque M. (2002). - Biological pollution in the Mediterranean Sea: invasive versus introduced macrophytes. Mar. Poll., 44: 32-38
- Cirik S. and Ozturk B. (1991) - Notes sur la présence d'une forme rare du *Caulerpa racemosa* en Méditerranée orientale. Flora Mediterranea, 1: 217-219.
- Debelius H. and Baensch H.A. (1997) - Marine Atlas. Microcosm Publ. : 1216p.
- Hamel G. (1926) - Quelques algues rares ou nouvelles pour la flore Méditerranée. Bull. Mus. Nat. Sci. Nat. Paris, 32 : 420.
- Panayotidis P. and Montesanto B. (1994) - *Caulerpa racemosa* (Chlorophyta) on the Greek coasts. Cryptogamie Algol., 15: 159- 161.
- Panayotidis P. and Zuljevic A. (2000) - Sexual reproduction of the invasive green alga *Caulerpa racemosa* var. *Occidentalis* in the Mediterranean Sea. Oceanol. Acta, 24:199-203
- Verlaque M., Boudouresque C.F. Meinesz A., Gravez V. (2000) - The *Caulerpa racemosa* complex (Caulerpales, Ulvophyceae) in the Mediterranean Sea. Bot. Mar., 43, : 49-68

MOLLUSQUES ASCOGLOSSES ASSOCIES AUX PEUPELEMENTS DE *CAULERPA RACEMOSA* EN TUNISIE: ESPECES OBSERVEES ET DESCRIPTION DES EFFETS TROPHIQUES.

Aslam Sami DJELLOULI, Habib LANGAR et Amor EI ABED

Faculté des Sciences de Tunis, Département de Biologie, Le Belvédère, Tunis-Tunisie.

RESUME

Des échantillons de *Caulerpa racemosa* var. *uvifera-turbinata*, ainsi que de *C. racemosa* var. *cylindracea*, prélevés dans différentes stations du littoral tunisien et cultivés en aquarium, ont révélé la présence au sein des peuplements échantillonnés d'*Oxynoe olivacea* et *lobiger* sp (mollusques, ascoglosses). Le suivi de ces cultures montre que *Caulerpa racemosa* constitue bien une source trophique pour ces espèces de mollusques. Il montre également que les effets de cette prédation conduisent à terme à une disparition de l'algue dans les milieux de culture. Par ailleurs, les auteurs ont pu également noter qu'*Oxynoe olivacea* se développait et se reproduisait dans ce milieu. Ces observations montrent qu'il existe en Méditerranée différentes espèces d'ascoglosses à même d'exercer une pression trophique naturelle sur *Caulerpa racemosa*.

INTRODUCTION

La récente introduction en Méditerranée, d'espèces appartenant au genre *Caulerpa*, a été suivie par leur rapide expansion donnant lieu à de vastes colonies, ce qui a valu à ces espèces le qualificatif d'envahissantes : en effet, depuis sa première signalisation en 1984 à Monaco (Meinesz et Hesse, 1991), *Caulerpa taxifolia* s'est largement répandue dans le bassin occidental de la Méditerranée où elle est représentée, à l'heure actuelle, dans 6 pays (Espagne, France, Monaco, Italie, Tunisie et Croatie). Bien que signalée en Méditerranée depuis 1926 (Hamel) *Caulerpa racemosa* connaît depuis les années 1990, une progression tout aussi rapide et il a été montré que celle-ci était liée à une nouvelle souche récemment introduite et identifiée comme appartenant à *Caulerpa racemosa* var. *cylindracea*, la souche répertoriée par Hamel (1926) étant attribuée à *C. racemosa* var *turbinata-uvifera* (Verlaque *et al.*, 2000 et Durand *et al.*, 2002). Le caractère envahissant de ces espèces, largement étudié, peut être attribué, entre autres facteurs, à une forte capacité de prolifération, une niche écologique très étendue mais également à une absence de prédation. Dans ce contexte, la présence de mollusques ascoglosses au sein de souches de *C. racemosa* prélevées en mer et cultivées en aquarium, révèle une possible prédation naturelle et a suscité de fait notre intérêt.

MATERIEL D'ETUDE

Les cultures de *C. racemosa* ont été réalisées au départ pour les besoins d'études de productivité et des études phénologiques. Deux types d'échantillons étaient mis en culture, les premiers appartiennent à la *var. turbinata-uvifera*, les seconds à la *var. cylindracea*. Ils ont été prélevés en mer dans des stations situées dans les régions suivantes (Fig. 1) :

- Cap zebib : pour la *var. turbinata-uvifera* ;
- Rafraf : pour les *var. turbinata-uvifera* et *var. cylindracea* ;
- Korbous *var. cylindracea*

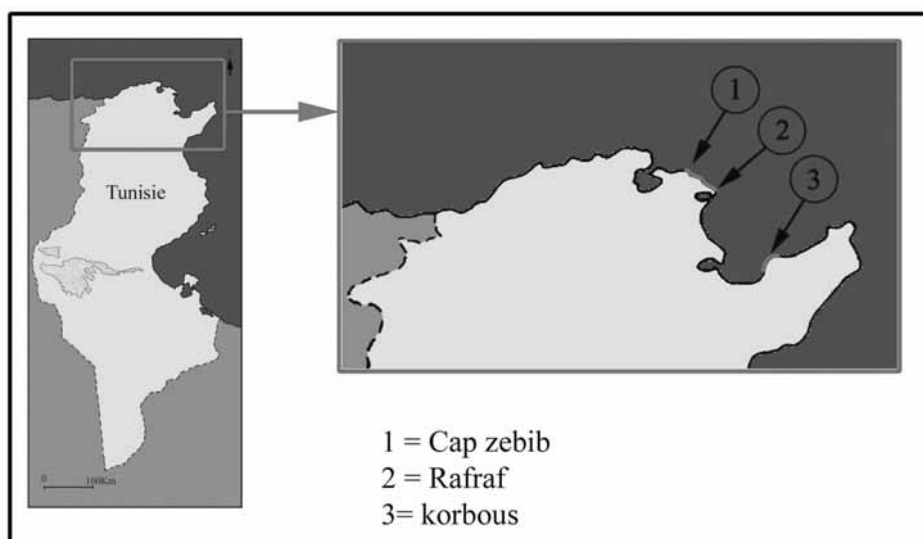

Fig. 1: Carte de répartition des stations de prélèvement

Dans chaque cas, les boutures de *C. racemosa* ont été prélevées avec leur substrat ainsi que les peuplements qui y étaient associés. Les boutures ont été directement placées en aquarium, sans traitement désinfectant préalable. Les aquariums aux dimensions de 30x30x30 cm étaient pourvus d'aérateurs. Un contrôle quotidien des cultures a été réalisé.

RESULTATS

Après quelques semaines de cultures, nous avons constaté, contrairement aux effets attendus, une forte diminution de la biomasse végétale. Consécutivement à cela nous avons observé dans nos échantillons la présence de différentes espèces d'ascoglosses.

1. *Lobiger* sp (Fig. 2) :

Les spécimens appartenant à cette espèce ont été trouvés dans les cultures de *C. racemosa* var. *cylindracea*, provenant de la région de Korbous au Cap bon. La présence de pseudopodes, d'une part, et d'une coquille nettement visible sous le manteau, d'autre part, nous a permis d'attribuer ces échantillons au genre *Lobiger*. Toutefois, il apparaît que les échantillons, de taille très petite (inférieure au mm), étaient probablement des juvéniles. Cet état nous a empêché d'effectuer avec certitude une détermination au niveau spécifique et de les attribuer à *L. serradifalci* Calcara.

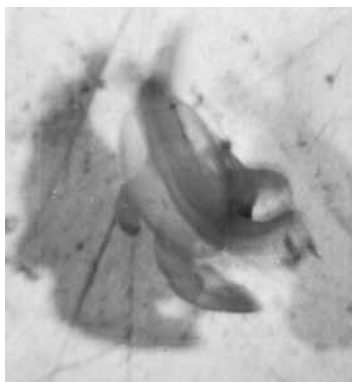

Fig. 2: *Lobiger* sp

Au total, deux échantillons ont été trouvés au sein de l'aquarium. Nous les avons extraits et isolés dans des enceintes plus petites afin de suivre plus aisément leur développement ainsi que leurs effets sur les thalles de *C. racemosa*. Ainsi, Nous avons pu constater que l'effet du pâturage au niveau des thalles se manifestait d'abord par l'apparition au niveau des pinnules, de petites barres blanches pouvant correspondre à des sites de succion. Par la suite, en l'espace de 1 à 2 jours, en fonction de la longueur des thalles, ceux-ci blanchissaient sur toute leur étendue et mourraient.

Les échantillons de *lobiger* sp étudiés n'ont pu être maintenus en vie que quelques jours, ce qui nous a empêché de poursuivre cette étude.

2. *Oxynoe olivacea* (Fig. 3) :

Les spécimens appartenant à cette espèce ont été trouvés dans les cultures de *C. racemosa* var. *turbinata-uvifera* ainsi que parmi les cultures de *C. racemosa* var. *cylindracea*, toutes deux récoltées à Cap zebib et Rafraf. La présence d'une coquille nettement visible sous le manteau et recouverte de replis cutanés toujours repliés, nous ont permis d'attribuer ces échantillons à *Oxynoe olivacea* Rafinesque.



Fig. 3: *Oxynoe olivacea*

Un total de sept échantillons a été trouvé réparti dans deux aquariums, quatre d'entre eux ont été régulièrement suivis et nous avons pu effectuer les observations suivantes :

- A l'instar de ce qui a été observé pour *Lobiger sp*, les échantillons d'*Oxynoe olivacea* trouvés dans nos cultures étaient des juvéniles ;
- Leur croissance s'effectuait normalement dans les aquariums et au contact de *C. racemosa* ;
- Les individus ont survécu plusieurs semaines et atteint une taille moyenne d'environ 25 mm ;
- Des pontes ont été observées sur les parois de l'aquarium ;
- L'effet du pâturage était observable au niveau des deux variétés de *C. racemosa*, il se manifeste par l'absence de pinules, et de fragments de thalles.
- Les populations de *C. racemosa* disparaissaient rapidement, de l'aquarium si bien que nous avons été obligés de les renouveler tous les 10 à 15 jours en moyenne.

DISCUSSION ET CONCLUSION

A l'instar de ce qui a déjà été observé par d'autres auteurs (Thibaut et Meniesz, 2000; Gianguzza, 2002), nos observations montrent que les populations d'ascoglosses méditerranéens se sont naturellement adaptées à se nourrir à partir des nouvelles espèces de caulerpes récemment introduites en méditerranée, dans notre cas il s'agit de *C. racemosa var turbinata-uvifera* ainsi que de *C. racemosa var. cylindracea*. D'autre part, nous n'avons pas constaté que la prédation par ces ascoglosses fragmentait et favorisait la dissémination des thalles ainsi que l'ont observé Zuljevic *et al.* (2001). Contrairement à ces observations, nous avons noté une diminution de *C. racemosa* dans nos aquariums et ceci quelque soit la variété. Il apparaît donc qu'il existe une prédation naturelle de *C. racemosa* par les ascoglosses méditerranéens et cette prédation pourrait constituer un moyen de contenir naturellement et à terme, l'expansion de ces dernières. Des études plus approfondies, notamment en ce qui concerne *Lobiger sp.* seraient souhaitables.

REFERENCES

- Durand C., Manuel M., Boudouresque C. F., Meinesz A., Verlaque M. et Le Parco Y. (2002) - Molecular data suggest a hybrid origin for the invasive *Caulerpa racemosa* (*Caulerpales*, *Chlorophyta*) in the Mediterranean Sea. *J. Evol. Biol.*, 15: 122-133
- Gianguzza P., Airoidi L., Chemello R., Todd C.D. et Riggio S. - (2002) - Feeding preferences of *Oxynoe olivacea* (Opisthobranchia: Sacoglossa) among three *Caulerpa* species. *J. Moll. Stud.*, 68: 289-290.
- Hamel G. (1926) - Quelques algues rares ou nouvelles pour la flore Méditerranéenne. *Bull. Mus. Hist. Nat. Paris*, 6: 420
- Meinesz A. et Hesse B. (1991) - Introduction et invasion de l'algue tropicale *Caulerpa taxifolia* en Méditerranée nord-occidentale. *Oceanologica acta*, 14 (4): 415-426.
- Thibaut, T., Meinesz, A. (2000) - Are the mediterranean ascoglossan molluscs *Oxynoe olivacea* and *Lobiger serradifalci* suitable agents for a biological control against the invading tropical alga *Caulerpa taxifolia*? *C. R. Acad. Sci. Paris, Sciences de la vie/ Life Sciences* 323: 477-488.
- Verlaque M., Boudouresque C.F., Meinesz A., Gravez V. (2000) - The *Caulerpa racemosa* Complex (*Caulerpales*, *Ulvophyceae*) in the Mediterranean Sea. *Botanica Marina*, 43 (1): 49-68.
- Zuljevic A., Thibaut T., Elloukal H., Meinesz A. (2001) - Sea slug disperses the invasive *Caulerpa taxifolia*. *J. Mar. Biol. Ass. U.K.*, 81, 3761/1-2.

INTERACTIONS ENTRE L'HERBIER A *POSIDONIA OCEANICA* ET L'HYDRODYNAMISME AU SEIN DE LA BAIE DE MONASTIR (TUNISIE ORIENTALE)

Zohra EL ASMI DJELLOULI¹, Aslam Sami DJELLOULI¹, Christine PERGENT-MARTINI,
G rard PERGENT, S adi ABDELJAOUED et Amor EL ABED

¹ Facult  des sciences de Tunis Manar, compus universitaire, 1060 Tunis TUNISIE

RESUME

L'implantation d'un herbier   *Posidonia oceanica* (L.) Delile est conditionn e par un ensemble de facteurs dont les principaux sont la qualit  des eaux, les apports s dimentaires et l'hydrodynamisme qui r git en grande partie les  l ments pr c dents (Jeudy de Grissac et Clairefond, 1979).

A partir de la typologie des herbiers rencontr s dans le secteur de Monastir, un essai de caract risation des conditions hydrodynamiques   l'origine de la mise en place de ces diff rents faci s est effectu . La dynamique s dimentaire est  valu e par le calcul des diff rents param tres et indices granulom triques des s diments de la matte. Les r ponses de l'herbier, aux conditions du milieu, sont appr hend es par une analyse ph nologique.

MOTS-CLES: *Posidonia oceanica*; herbier ondoyant; hydrodynamisme; s diments

INTRODUCTION

Les herbiers   *Posidonia oceanica* (L.) Delile sont des formations extr mement fr quentes le long du littoral tunisien. En effet cette magnoliophyte marine, end mique du bassin m diterran en, est pr sente sur substrat meuble de la surface jusqu'  40 m de profondeur en eaux claires (Molinier et Picard, 1952). N anmoins on connait diff rents types d'herbiers. Cette typologie est principalement conditionn e par la nature du substrat, l'intensit  des apports s dimentaires et les conditions hydrodynamiques (Clairefond et Jeudy de Grissac 1979). La r alisation d'une cartographie des principaux peuplements et types de fonds de la baie de Monastir a permis de mettre en  vidence l'importance des herbiers sous-marins (El Asmi-Djellouli *et al.* 2001), mais  galement une certaine h t rog nit  d'un secteur   l'autre de la baie. Afin de mieux cerner les interactions entre les herbiers   *Posidonia oceanica*, l'hydrodynamisme et la dynamique s dimentaire de cette baie une analyse plus approfondie du fonctionnement de l'herbier est envisag e ainsi que la prise en compte des param tres s dimentologiques.

MATERIEL ET METHODES

Le site d' tude est constitu  par la baie de Monastir, qui appartient au littoral Est tunisien dont le prolongement est la mer p lagienne (Buruollet, 1979). Partie int grante de la c te

sahélienne, située entre les latitudes 35° 50 – 35° 40 et les longitudes 10° 47 - 10° 55, cette région est incluse dans le golfe d' Hammamet, dont elle représente le secteur Sud.

Lors de l'étude cartographique (El Asmi-Djeloulli *et al.*, 2001), 35 stations réparties sur toute la baie, de la ville de Monastir au Nord, aux îles Conigliera au Sud ont été prospectées (Fig. 1). Des prélèvements de 20 faisceaux orthotropes de *Posidonia oceanica* sont effectués dans trois stations (9, 18 et 40 ; Fig. 1), se situant respectivement à des profondeurs de 9 m, 1 m et 15 m. Ces prélèvements sont réalisés à différentes saisons, de novembre 2000 à septembre 2001. A l'issue du prélèvement, les faisceaux sont conservés dans l'alcool à 60°, technique qui permet après réhydratation, au laboratoire, de retrouver un matériel proche de l'état frais. Les faisceaux sont ensuite étudiés selon le protocole de Giraud (1979) qui permet de déterminer les paramètres phénologiques de *Posidonia oceanica*, pour chaque station.

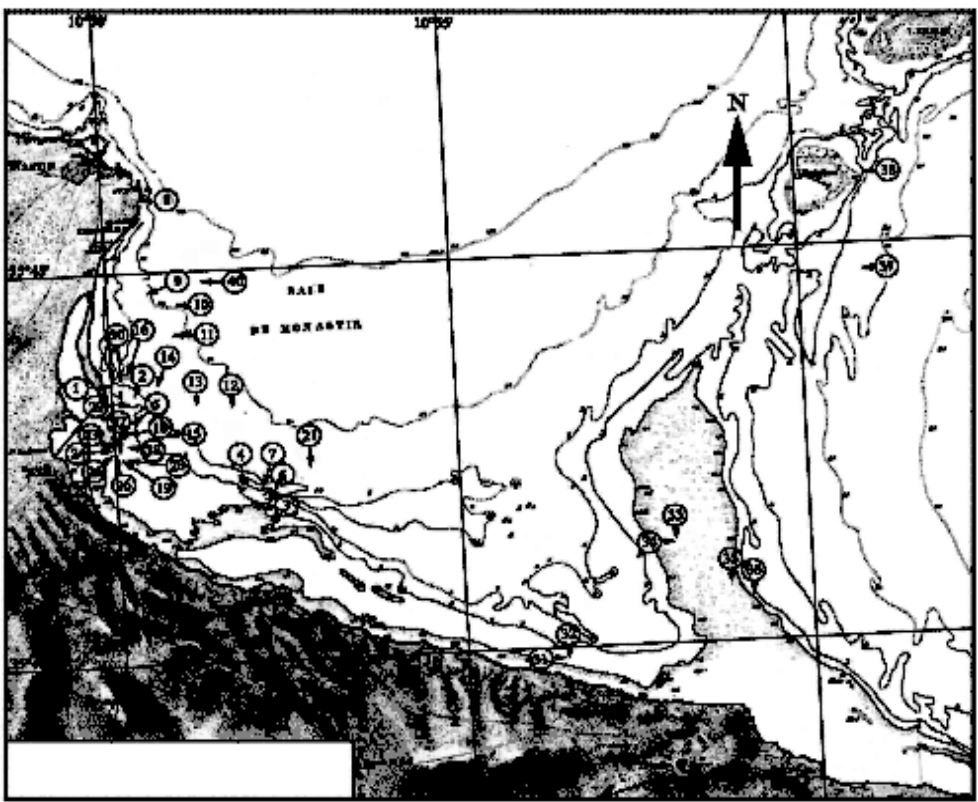

Fig. 1: Carte de répartition des stations investiguées lors de la campagne cartographique. Les numéros des stations où sont réalisés l'étude phénologique et l'étude sédimentologique sont indiqués.

Les sédiments sont échantillonnés, en plongée, en scaphandre autonome selon la technique mise au point par Boudouresque *et al.* (1984), à l'aide d'un carottier enfoncé dans la matie. Les feuilles vivantes des rhizomes sont coupées au niveau de la ligule. Avant l'extraction de la carotte et sa remontée à la surface, un couvercle placé à sa partie inférieure permet d'éviter le lessivage des sédiments. Trois réplicats sont effectués sur chaque station et 10 stations sont échantillonnées: (9) représente l'herbier ondoyant de type I; (2, 13, 14, 15, et 16), l'herbier ondoyant de type II, (10 40) l'herbier de plaine et (5 et 18), le «récif-barrière». (fig. 1). Les carottes, à l'issue du prélèvement, sont congelées et conservées jusqu'à leur analyse. Au laboratoire, sur chaque carotte on effectue la séparation des sables de la fraction silto-argileuse (tamisage à 63 µm, voie humide) puis après séchage une analyse granulométrique des sables est effectuée (tamis de type Afnor, à diamètres compris entre 2000 et 63 µm). Les poids relatifs de chaque classe granulométrique sont ensuite notés.

RESULTATS ET DISCUSSION

L'herbier de *Posidonia oceanica* colonisant l'étage infra-littoral de la Baie de Monastir se présente, en fonction de la profondeur, sous trois types différents.

Parallèlement à la côte et aux lignes bathymétriques, il se présente, entre les profondeurs de 80 cm à 1 m et jusqu'à 3 m, sous la forme d'un «récif-barrière» (Molinier et Picard 1952 ; Boudouresque et Meinesz 1982) caractéristique des fonds de baie abrités. Un herbier ondoyant (Clairefond et Jeudy de Grissac 1979), tapisse les profondeurs comprises entre 3 et 9 m. A partir de 10 m et jusqu'à des profondeurs estimées entre 25 et 30 m, c'est un herbier de plaine qui prend le relais.

Si l'herbier de plaine et le «récif-barrière» sont les témoins d'un hydrodynamisme calme, l'herbier ondoyant voit sa mise en place gérée par des conditions hydrodynamiques complexes.

Ce dernier se présente sous forme de bandes, parallèles à la côte, de *Posidonia oceanica* en alternance avec des bandes de sables nus ou colonisés par un autre type de végétation, l'algue *Caulerpa prolifera*.

L'interférence entre l'onde incidente, et l'onde réfléchiée crée cette structure en bandes. L'orientation nord ouest – sud est, des bandes (stations 9 ; 2 ; 13 ; 14 ; 15 ; et 16) rend compte de la présence d'une houle venant se marquer régulièrement et générée par des vents dominants, soufflant en hiver, de direction nord est-sud ouest.

Une micro-cartographie effectuée au sein de la station 9 située à 6 m de profondeur, donne pour les bandes d'herbier une longueur moyenne de 14 m et une largeur moyenne de 8 m. (fig. 2).

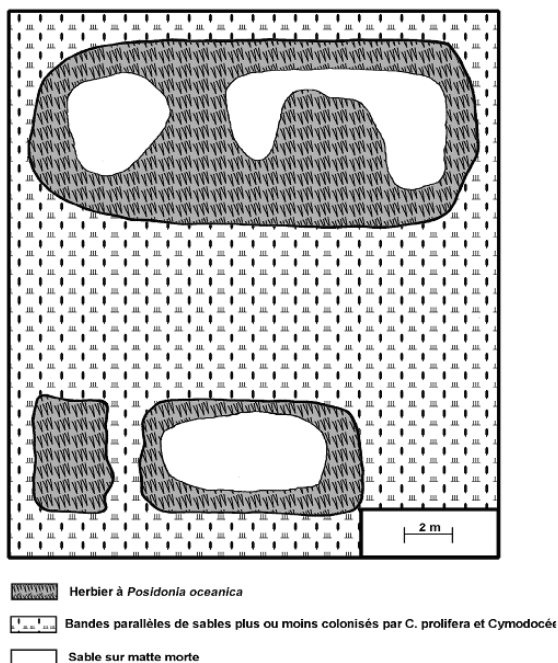

Fig. 2 : Micro-cartographie de l'herbier ondoyant – station 9

Le traitement des données sédimentologiques se base sur le calcul des paramètres granulométriques, Mz (grain moyen) (Folk, 1966) et * (indice de classement), exprimés en échelle phi. On retiendra de même la répartition de la fraction fine (tableau I). Parce que le grain moyen et la déviation standard renseignent sur le niveau d'énergie qui trie et classe les sédiments, nous évaluerons ces paramètres en tenant compte de la typologie de l'herbier. La répartition de la fraction inférieure à 63 µm, nous renseigne sur les zones préférentielles de dépôt de particules fines qui sont le reflet d'un hydrodynamisme calme.

Tableau 1: Teneur en fraction fine, et paramètres granulométriques des sédiments de la matte en fonction de la typologie de l'herbier

Type d'herbier	Herbier de plaine	Récif-barrière	Herbier ondoyant 1	Herbier ondoyant 2
% F < 63µm	48 + 17	38 + 2	26 + 11	23 + 8
Mz (phi)	3 + 0,8	2,4 + 0,2	1,5 + 0,7	1,9 + 0,4
* (phi)	0,9 + 0,5	1,2 + 0,2	1,2 + 0,2	1,3 + 0,2

Au niveau de l'herbier de plaine représenté par les stations (10 et 40), les sédiments, caractérisés par la teneur en fraction fine F = 48 + 17 %, à Mz = 1 + 0,8 phi et * = 1,8 + 0,5 phi, sont des sables très fins, assez bien classés, à fraction inférieure à 63 µm importante. Ils reflètent un domaine à hydrodynamisme calme.

Les sédiments de l'herbier ondoyant, qu'il soit de type 1 (9), ou de type II, (2 ; 13 ; 14 ; 15 ; 16) sont des sables moyens médiocrement classés et à fraction fine faible : 26 + 11 et 23 + 8. Ils sont les témoins de fonds à hydrodynamisme assez important. Au sein du «récif-barrière» (stations 5 et 18) les sédiments sont des sables fins moyennement classés, la fraction fine déposée, assez importante témoigne d'un hydrodynamisme plutôt calme.

Les réponses phénologiques des différents types d'herbiers sont résumées (Fig. 3) Pour l'herbier de plaine, à hydrodynamisme calme, les feuilles adultes restent attachées sur le rhizome (3,3 en mai et 3,5 en sept) aucune chute notable n'est enregistrée (Fig. 3 a).

Au niveau de l'herbier ondoyant, (Fig. 3 b). Une baisse importante du nombre des feuilles adultes (2,7) est enregistrée au printemps. Cette chute est directement liée à un hydrodynamisme hivernal important au sein de ce type d'herbier.

C'est ce même hydrodynamisme qui entraîne la mise en place de ce type d'herbier. A cette période ce sont les vents Nord à variante Est qui dominent.

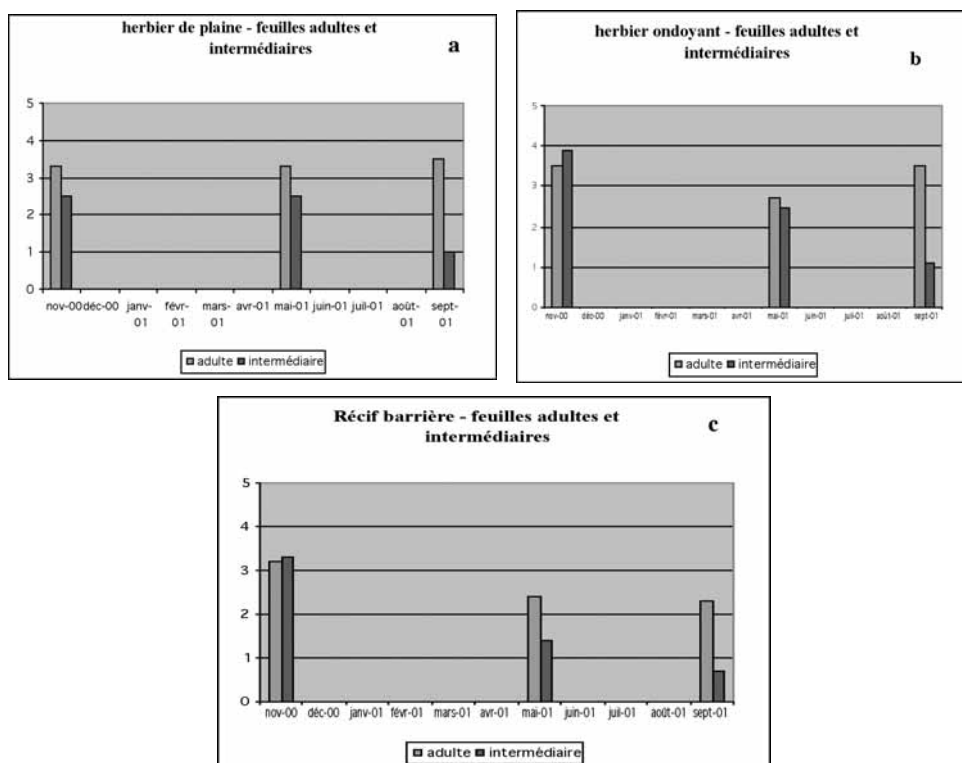

Fig. 3. (a ; b ; c) : Nombre de feuilles adultes et intermédiaires, en fonction des saisons et des stations.

Un nombre faible de feuilles adultes est de même enregistré au sein du «récif-barrière» (Fig. c).

L'hydrodynamisme hivernal se répercute sur cette formation, entraînant une chute des feuilles les plus exposées.

CONCLUSION

Les interactions entre l'herbier à *Posidonia oceanica* et l'hydrodynamisme au sein de la baie de Monastir sont matérialisés dans un premier temps par la typologie variable de l'herbier. Entre 3 et 9 m, nous relevons, ainsi, la présence d'un herbier ondoyant, qui s'installe en réponse à des conditions hydrodynamiques particulières. En deçà de ces profondeurs, la présence d'un «récif barrière» caractéristique des fonds de baie abrités, atteste d'un hydrodynamisme calme. Au delà de 9 m et jusqu'à des profondeurs moyennes de 25 m on rencontre un herbier de plaine, témoin d'un hydrodynamisme régulier et calme. La répartition et la caractérisation des faciès sédimentaires, montrent que l'herbier de plaine, est une zone calme et préférentielle de dépôt de sédiments à tendance sablo-silteuse. L'hydrodynamisme important élimine la fraction fine au sein de l'herbier ondoyant.

Enfin la réponse phénologique montre que l'hydrodynamisme calme permet le maintien, au sein de l'herbier de plaine et tout au long de l'année, des feuilles de *Posidonia oceanica* sur les rhizomes. Par contre, les houles hivernales responsables de la mise en place de l'herbier ondoyant, entraînent une chute printanière des feuilles âgées. Cette chute enregistrée au printemps est directement liée aux variations des conditions hydrodynamiques résultant des vents dominants hivernaux de direction nord à variante est.

REFERENCES

- Boudouresque C.F., Jeudy De Grissac A., Meinesz A. (1984) - Relations entre le sédiment et l'allongement des rhizomes orthotropes de *Posidonia oceanica* dans la baie d'Elbu (Corse). In «*International Workshop Posidonia oceanica Beds*», Boudouresque C.F., Jeudy de Grissac A. et Olivier J. edit., GIS Posidonie publ., 1 : 185-191.
- Boudouresque C.F., Meinesz A. (1982) - Découverte de l'herbier de Posidonie. Cahier N°4. Edit. Parc National Porc-Cros, Parc Naturel Régional de la Corse et GIS Posidonie. 80 pp.
- Burollet P.F. (1979) - Climat et hydrologie. Annales de l'Université de Provence Géologie Méditerranéenne. Tome VI N°1 : 28-34.
- El Asmi-Djellouli Z., Djellouli A., Pergent G., Abdeljaoued S. (2001) - Anthropic impact on the *Posidonia oceanica* meadows, in the Monastir Bay Tunisia. "In *Fifth International Conference on the Mediterranean Coastal Environment, MedCoast 01*" E. Ozhan edit., MEDCOAST Secret. Middle East Technical Univ. Pub., Ankara: 198-202.

Folk R.L. (1966) - A review of grain-size parameters. *Sedimentology*, Oxford, V.6 : 73-79.

Giraud. (1977) - Contribution à la description et à la phénologie quantitative des herbiers à *Posidonia oceanica* (L.) Delile. Thèse Doct. 3ème Cycle, Univ.Aix-Marseille : 1-150.

Giraud G. (1979) - Sur une méthode de mesure et de comptage des structures foliaires de *Posidonia oceanica* (Linnaeus) Delile. *Bull. Mus. Hist. Nat. Marseille*, 39 : 131-132.

Clairefond P., Jeudy De Grissac A. (1979) - Description de structures sédimentaires en milieu marin : recensement de quelques exemples dans l'herbier de Posidonies autour de l'île de Port-Cros (Parc national). *Travaux Scientifiques du Parc National de Port-Cros*, 5 79-104.

Molinier R., Picard J. (1952) - Recherches sur les herbiers de Phanérogames marines du littoral méditerranéen français. *Ann. Inst. océanogr.*, Paris, 27 (3) : 157-234.

CAULERPA TAXIFOLIA: SITUATION CONNUE EN TUNISIE AU 31 JUILLET 2003

Habib LANGAR¹, Aslam Sami DJELLOULI² et Amor EL ABED¹

¹ Institut National des Sciences et Technologies de la Mer, 28 Rue du 2 mars 1934 – 2025 Salammbô – Tunisie

² Faculté des Sciences de Tunis, Campus Universitaire – 1005 Tunis – Tunisie

RESUME

Au 31 juillet 2003, la présence de *Caulerpa taxifolia* (Vahl) C. Agardh a été confirmée dans la Rade de Sousse (Côte Est de la Tunisie) et dans la région du Cap Bon (Nord-Est de la Tunisie) dispersé de Sidi Daoud à El Haouaria. Le linéaire de côte cumulé face auquel *C. taxifolia* est présent approcherait la vingtaine de kilomètres. Un carré permanent installé dans une zone particulière de la Rade de Sousse nous a permis de suivre la progression d'une colonie de *C. taxifolia*, couvrant approximativement 700 cm² en début d'expérience. Au bout de deux années de suivi, la colonie s'est étendue sur une superficie atteignant 7,25 m². *Caulerpa taxifolia* dans les conditions de ce travail semble éprouver des difficultés à s'installer sur le fond meuble du chenal d'intermatte de *Posidonia oceanica* et se développer dans les zones de l'intermatte recolonisées par la Posidonie.

KEYWORDS: *Caulerpa taxifolia*, Cartography, Distribution, Kinetic, Tunisia

INTRODUCTION

La découverte de *Caulerpa taxifolia* (Vahl) C. Agardh, dans les eaux marines tunisiennes a eu lieu au début de l'année 2000 dans la rade de Sousse (Langar *et al.*, 2000). Cette découverte fut le résultat d'une première campagne de prévention et de sensibilisation à l'introduction de *Caulerpa taxifolia* en Tunisie lancée depuis 1997 (Langar *et al.*, 1998). Depuis, les campagnes de sensibilisation se sont intensifiées, multipliant la distribution sur tout les usagers de la mer (plaisanciers, pêcheurs, capitaineries des ports, club de plongées,...) de brochures permettant la reconnaissance de l'algue, et invitant toute personne qui la rencontre à la signaler à un service compétent à l'Institut National des Sciences et Technologies de la mer de Salammbô à Tunis, précisant quelque données relatives à son observation. De même, des rencontres avec les pêcheurs et les plongeurs amateurs ont eu lieu pour leur apprendre à reconnaître l'algue et leur expliquer la conduite à tenir en cas de sa découverte. Toute signalisation est suivie d'un déplacement de spécialistes sur les lieux de la découverte, pour vérification de l'information. Une délimitation de la zone concernée par la présence de l'algue a lieu en cas de confirmation de l'information.

Le but de ce papier est de donner un état de la situation relative à la distribution connue de *Caulerpa taxifolia* en Tunisie au 31 juillet 2003 et de présenter les premières données sur la dynamique de l'expansion de cette algue obtenues pour la première fois sur le littoral oriental de la Méditerranée.

MATERIELS ET METHODES

1 - Délimitation des zones concernées

L'approche standard proposée par de Vaugelas *et al.*, 1999 pour la cartographie de l'expansion de *Caulerpa taxifolia* est adoptée dans le présent travail. C'est ainsi que par zone concernée il est entendu toute surface atteinte dépassant les 10 ha et où il devient très difficile de rechercher les colonies périphériques pour délimiter le polygone convexe de la surface atteinte. Le terme station étant défini comme étant toute surface plus ou moins colonisée par *Caulerpa taxifolia* avec une ou plusieurs colonies proche les unes des autres.

La première station à *Caulerpa taxifolia* découverte en Tunisie a été cartographiée en mars 2000 suite à une campagne de prospection sous-marine dans la zone où l'algue a été découverte (Langar *et al.*, 2002). Cette méthode, très coûteuse en terme de moyens et de temps nous a incité à adopter une autre méthodologie pour le suivi de l'évolution de cette zone et pour cartographier les nouvelles stations découvertes. Cette méthodologie se déroule en deux étapes. En un premier lieu des enquêtes sur la présence de l'algue sont menées auprès des usagers de la mer (plongeurs et pêcheurs) fréquentant le voisinage des zones à *Caulerpa* connues ou nouvellement signalées, ce qui nous permet de délimiter approximativement la zone concernée. En second lieu, des plongées de confirmation de la présence de l'algue dans les points suspects relevés lors des enquêtes, et dans leurs voisinages, sont réalisés ce qui nous permet de limiter la vraie surface concernée délimitée par la position des colonies les plus périphériques.

2 – Dynamique de l'expansion

Un filet carré de 10 m de côté avec un maillage de 50 cm de côté de maille a été étendu dans la rade de Sousse sur une aire de la zone concernée par la présence de *Caulerpa taxifolia*. Cette aire est située, par 13,5 m de profondeur, dans un chenal intermatte de *Posidonia oceanica* (L.) Delile. Sableuse en son milieu, elle est bordée de part et d'autre par des bandes sablo-vaseuses recolonisées par la Posidonie. Dans ce carré, et à la frontière sable-posidonie était implantée, en début d'expérience, une colonie de *Caulerpa taxifolia* d'une superficie d'environ 700 cm². L'évolution de la superficie de cette colonie a été suivie trimestriellement sur une période de deux années par des observations et des mesures faites en plongées autonomes.

RESULTATS ET DISCUSSION

1- Distribution actuelle

La cartographie de la première station à *Caulerpa taxifolia* découverte dans la rade de Sousse a permis de limiter une zone concernée de 350 ha face à un linéaire de côte d'environ 2 km (Langar *et al.*, 2002). La surface couverte était alors estimée entre 0,5 et 1 ha. Les prospections faites depuis, par plongées autonomes, et arrêtées à juin 2003, ont fait état d'une extension de la surface concernée d'une part en direction du port de pêche et d'autre part vers le sud-est de la zone initialement découverte en direction de la zone dite de "Sidi Abd Elhamid" occupée par un herbier de posidonie. La nouvelle zone ainsi délimitée est estimée à environ 1558 ha située face un linéaire de côte d'environ 5 km. Plusieurs centaines de colonies de l'algue sont dispersées dans toute la surface concernée, par des profondeurs allant de 4 à 20 mètres avec un taux de couverture estimé à 2 %. La surface couverte a été, par conséquent, estimée à 31 ha (Figure 1). La dispersion des colonies de *Caulerpa* dans la zone concernée ne pourrait pas être expliquée par un développement naturel de l'algue, ou par un déplacement de bouture par les courants marins. Le développement accru de l'algue dans la zone de «Sidi Abd El Hamid», pêcherie fréquentée par les pêcheurs traditionnels (pêcheurs au filet à partir de barques non motorisées), nous incite à émettre l'hypothèse que son implantation est liée à un transport de boutures par les filets de pêches. La présence de l'algue en direction du port pouvant être expliquée par des implantations de boutures rejetées par les pêcheurs traditionnels lors de l'opération de nettoyage de leurs filets, qui a lieu classiquement lors du retour au port. Bien que les conséquences de telles pratiques soient bien expliquées lors de nos campagnes de sensibilisation, elles demeurent d'usage. Nos appels à la signalisation de l'algue étant intensifiées depuis l'installation de *Caulerpa taxifolia* à Sousse, plusieurs alertes à la présence de l'algue nous sont parvenues. Celles ci se sont avérées toutes erronées due à la confusion avec d'autres algues et plus particulièrement avec *Caulerpa racemosa* (Forskaal) J. Agardh. Ce n'est qu'en octobre 2001 que *Caulerpa taxifolia* fut retrouvée dans la zone du Cap Bon au Nord-est de la Tunisie à deux milles au Nord du port de «Sidi Daoud» par 25 m de profondeur, sur un fond occupé par un herbier de posidonie peu dense. Les enquêtes préliminaires au près des pêcheurs nous ont révélé l'existence de l'algue sur une large étendue, tout le long de la côte allant de «Sidi Daoud» à «Ras Adar» (Cap Bon). Les plongées de vérification nous ont cependant permis de délimiter, à la fin juillet 2003, quatre stations au sens de Vaugelas *et al.* (1999) (Fig. 1):

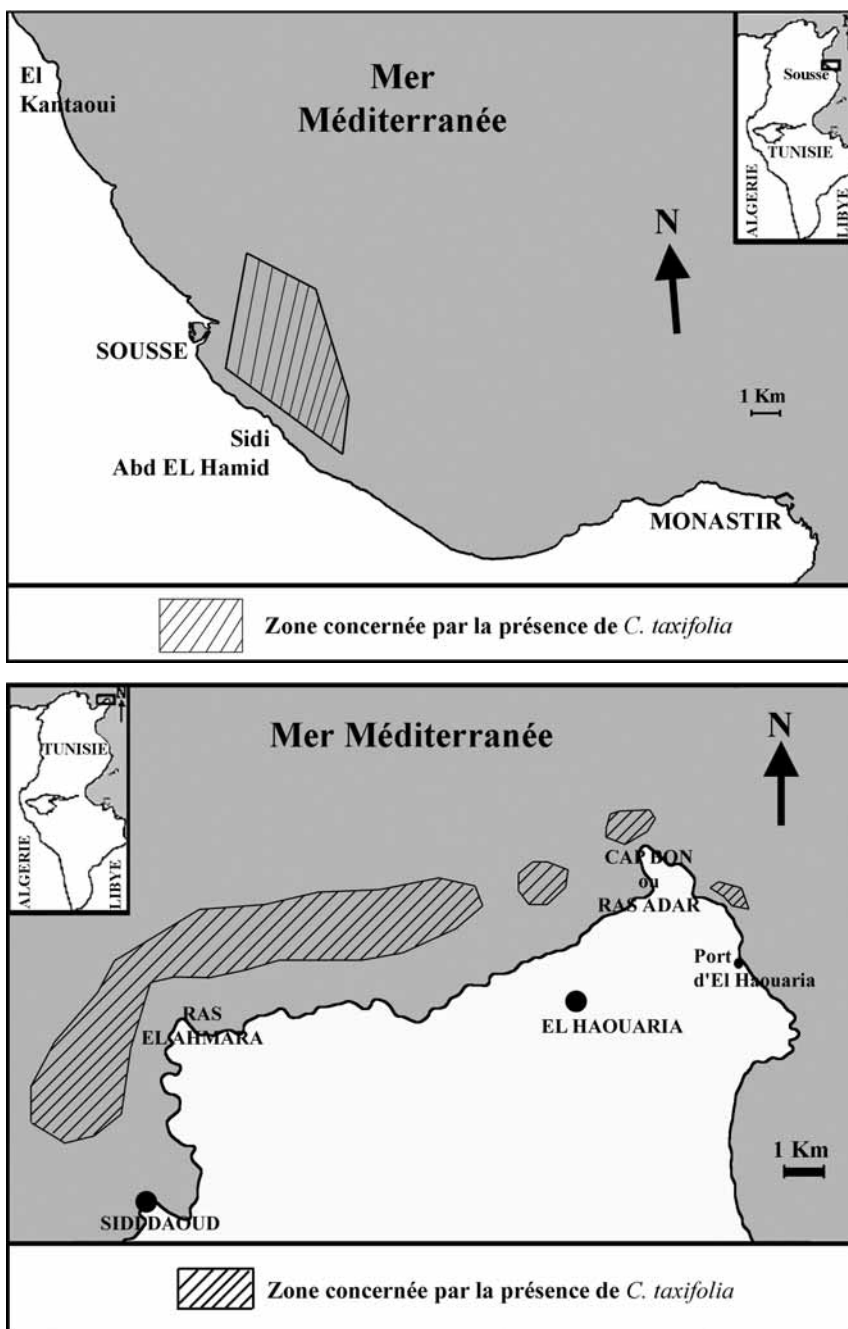

Fig 1 : localisation de *Caulerpa taxifolia* dans les régions de Sousse (carte du haut) et du Cap Bon (carte du bas)

- Station «Ras El Ahmara» : limitée par le point d'implantation de la Madrague (Pêcherie fixe de thon) de Sidi Daoud située à 3 milles Sud-Est du cap «Ras El Ahmara» et s'étendant le long de la côte contournant le cap pour s'arrêter à 5 milles Nord-Est du cap. Cette station, proche du port de pêche côtière de «Sidi Daoud», fait face à un linéaire de côte d'environ 9,5 Km et couvre environ 2041 ha de fond, où le substrat est soit sableux, soit rocheux soit constitué d'une matre morte ou couvert de posidonie. *Caulerpa taxifolia* est éparpillée dans toute la station par des profondeurs variant entre 14 et 45 m, parfois difficilement discernable entre les feuilles denses de Posidonie. Le taux de recouvrement est estimé à 3 % ce qui permet d'estimer la superficie réellement couverte à 61,1 ha.
- Station «El Haouaria» : Située au Nord de la ville «El Haouaria» face à un linéaire de côte de 1,5 Km. Elle couvre une superficie d'environ 100 ha à fond principalement rocheux et profonde de 35 à 40 m. *Caulerpa taxifolia* n'est pas très fréquente dans la station, elle couvre environ 0,5 % de la surface concernée (0,5 ha).
- Station «Ras Adar» : située au niveau du «Cap Bon» dit aussi «Ras Adar» face à un linéaire de côte d'environ 2 Km. Cette station est rocheuse et couvre une superficie de 80 ha dont à peine 0,5 % (0,4 ha) sont colonisés par *Caulerpa taxifolia*. L'algue dans cette station est implantée par des profondeurs allant de 19 à 50 m.
- Station du «Port El Haouaria» : Située au Nord du port d'«El Haouaria» devant un linéaire de côte d'environ 1,5 Km, elle est rocheuse et couvre environ 32 ha faiblement colonisés par *Caulerpa taxifolia* (0,5 % de couverture soit 0,16 ha). La profondeur de cette station varie entre 37 et 45 m.

L'arrivée de *Caulerpa taxifolia* dans la région du Cap Bon, comme dans le cas de la région de Sousse, n'est certainement pas le résultat d'une progression naturelle de l'algue. Son introduction liée à un transport de bouture par des embarcations de pêche ou de plaisance s'avère l'hypothèse la plus probable. Cette introduction aurait été faite à un endroit de la station «Ras El Ahmara» et la pêche côtière (activité principale de la région) a contribué fortement à sa dissémination dans le restant de la région face à un linéaire de côte cumulé de 14,5 Km, sur une surface concernée cumulée de 2253 ha dont 62,16 ha sont réellement couverts. Il reste à souligner que la subdivision de l'ensemble de la zone concernée de la région en quatre stations distinctes selon les critères de Vaugelas *et al.*, (1999), pourrait dans le cas présent paraître superflue vue la proximité des stations l'une de l'autre et l'incertitude sur l'inexistence de l'algue entre les espaces inter-stations: une colonie de l'algue pouvant échapper à la vigilance du plongeur surtout en conditions de forts courants et grandes profondeurs qui caractérisent la région du Cap Bon.

Au 31 juillet 2003, la Tunisie dispose donc d'une superficie concernée globale d'environ 3811 ha devant un linéaire de côte de 19,5 Km. La superficie réellement couverte serait de 93,16 ha.

2 – Dynamique de l'expansion

Après deux années, la surface de la colonie de *Caulerpa taxifolia* qui en début d'expérience était de 0,07 m² a été estimée à 7,25 m². Cette potentialité de croissance, bien qu'importante, ne semble pas diverger de celle décrite par Meinesz *et al.*, (1997)

dans les conditions de la Méditerranée Nord Occidentale. La similarité des souches de *Caulerpa taxifolia* de Tunisie et de celle de la Méditerranée Nord Occidentale (Langar *et al.*, 2001), et les températures saisonnières de l'eau dans la rade de Sousse variant entre 15 et 20 °C différant peu de celles des stations occupées par *Caulerpa taxifolia* en Méditerranée Nord occidentale laissait présager une similarité de la dynamique de croissance de l'algue en rade de Sousse et en Méditerranée Nord occidentale.

Dans nos conditions expérimentales, et au début de son développement, correspondant à la période de la première année de suivie, l'expansion de *Caulerpa taxifolia* a été relativement lente et s'est faite en grande partie sur le fond sableux (fig. 2), l'infiltration entre les rhizomes de *Posidonia oceanica* étant minimale, comme si la Posidonie opposait une résistance à cette infiltration. A partir de la deuxième année de croissance *C. taxifolia* s'est infiltrée plus rapidement et plus profondément dans l'herbier à Posidonie. Le scénario décrivant la résistance de *Posidonia oceanica* au cours des premières années de contact avec *C. taxifolia* finissant par un envahissement total de l'herbier au cours de quatre années de compétition fut déjà avancé par Meinesz *et al.*, (1997) en décrivant l'impact de *Caulerpa taxifolia* sur les herbiers de Posidonie en Méditerranée Nord occidentale. L'adoption de ce scénario dans nos conditions expérimentales tributaire de l'évolution de la superficie occupée par *Caulerpa taxifolia* au cours des quelques années à venir.

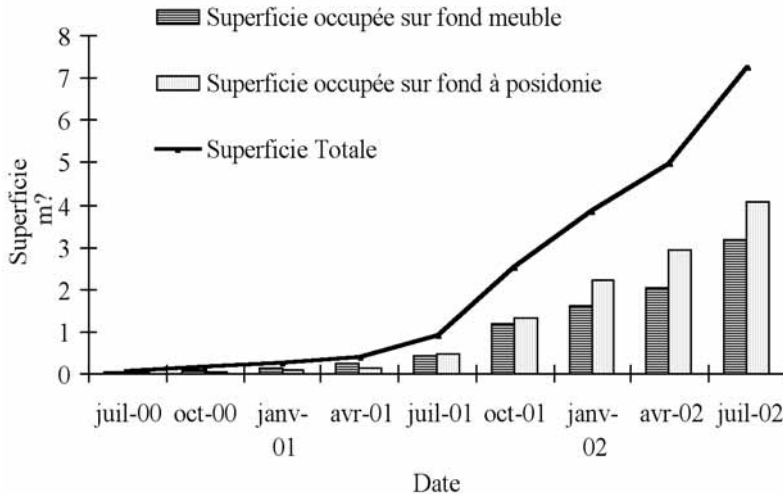

Fig 2. Evolution de la superficie d'une colonie de *Caulerpa taxifolia* dans la rade de Sousse au cours de deux années

CONCLUSIONS

Bien que répondant à une situation particulière, la cinétique de l'expansion de *Caulerpa taxifolia* sus décrite et son impact sur l'herbier de Posidonie restent préoccupants. Un suivi à plus long terme dans plusieurs conditions écologiques différentes devrait nous éclairer quant à l'avenir de nos écosystèmes littoraux. Sans dissémination naturelle ou anthropique de l'algue, la zone concernée de Sousse n'aurait pas augmentée de 4,5 fois en trois années et demie. La lutte contre la progression de *Caulerpa taxifolia* est indissociable de mesures concrètes de prévention de sa dissémination à partir des peuplements existants. Il conviendrait de mieux informer les usagers de la mer (pêcheurs et plaisanciers en particulier) sur les modes de dissémination anthropique de l'algue afin d'éviter tout comportement favorisant son expansion.

REFERENCES

- De Vaugelas J., Meinesz A., Antolic B., Ballesteros E., Belsher T., Cassar N., Ceccherelli G., Cinelli F., Cottalorda J., Frada'Orestano C.M., Grau A., Jaklin A., Morucci C., Rellini M., Sandulli R., Span A., Tripaldi G., Van Klaveren P., Zavodnik N. and Zuljevic A. (1999) - Proposition for a standardization of map representation of *Caulerpa taxifolia* expansion in the Mediterranean sea. *Oceanol. Acta*, 22: 85-94
- Langar H, Djellouli A. Ben Mustapha K., and El abed A. (1998) - Campagne de prévention et de sensibilisation à l'introduction en Tunisie de *Caulerpa taxifolia*. In : (C. F. Boudouresque, V. Gravez, A. Meinesz and F. Pally, eds) Third International Workshop on *Caulerpa taxifolia*, Marseille, 19-20 septembre 1997. GIS Posidonie Publ., Marseille : 17-20.
- Langar H, Djellouli A. Ben Mustapha K., and El Abed A. (2000) - Première signalisation de *Caulerpa taxifolia* (Vahl) J. Agarth en Tunisie. *Bull. Inst. Natn. Scien. Tech. Mer (Tunisie)*, 27 (1): 1-8.
- Langar H, Djellouli A. S., Sellem F. and El Abed A. (2002) - Extension of two *Caulerpa* species along the Tunisian coast. *Journal of Coastal Conservation*, 8: 163-167
- Meinesz A., Cottalorda J.M., Chiaverini D., Braun M., Carvalho N., Febvre M., Ierardi S., Mangialajo L., Passeron-Seitre G., Thibut T., Vaugelas J. De. (1997) - Suivi de l'invasion de l'algue tropicale *Caulerpa taxifolia* devant les côtes française de la Méditerranée: Situation au 31 décembre 1996. Ed. Laboratoire Environnement Marin Littoral, Université de Nice-Sophia Antipolis : 190 pp.

CONTRIBUTE TO THE KNOWLEDGE OF MACROALGAL BIODIVERSITY OF THE LIGURIAN COAST

Luisa MANGIALAJO¹, Giuseppina BARBERIS and Riccardo CATTANEO VIETTI

*Dipartimento per lo Studio del Territorio e delle sue Risorse, Università degli studi di Genova C.so Europa 26, 16132 GENOVA.
Author: Luisa Mangialajo, luisama@dipteris.unige.it*

ABSTRACT

The macrophytobenthos of Liguria (North-Western Mediterranean) was object of various studies in the past: bibliography anterior to 1950 enumerates more than 400 species (as well as other intraspecific taxa). On the other hand recent data concerning this region are scarce and often published in grey literature. In the checklist of Italian macrophytobenthos (Furnari *et al.*, 2003), only 119 species are enumerated between 1950 and 2000. The present work reports new records for the area and contains bibliography, herbaria and unpublished data. More than 50 entities are inedited quotations. A comparison between actual and historical data is here carried out, showing an increase of elements with warm affinities and a decrease of the cold ones.

KEYWORDS: Macrophytobenthos, biodiversity, Liguria

INTRODUCTION

The macrophytobenthos of Liguria (North-Western Mediterranean, Fig. 1) was object of various studies in the 19th century until the beginning of the 20th. Litterature anterior to 1950 enumerates more than 400 species (and other intraspecific taxa); most of these being reported by Ardissonne & Strafforello (1877).

Recent data concerning this region are scarce, often being published in grey literature. In the checklist of Italian macrophytobenthos (Furnari *et al.*, 2003), only 116 entities are enumerated for Liguria between 1950 and 2000, 116 of which belong to Rhodophyta, Phaeophyta and Chlorophyta, the only taxa considered in this study.



Fig. 1: Liguria

MATERIAL AND METHODS

The research of actual records from 1950 on was carried out in literature (Tortonese, 1958, 1961; 1962; Relini *et al.*, 1986; Balduzzi *et al.* 1993; Cattaneo-Vietti *et al.*, 2002; Furnari *et al.*, 2003), in Herbaria (GDOR, GE, HbMangialajo) and in the field. Historical data were searched in the literature (Ardissonne, 1883, 1886; Piccone, 1885; Ardissonne and Strafforello., 1887; Vinassa, 1891a, 1891b; Preda, 1904, 1917; Tosco, 1958) and in Herbaria (GDOR, GE).

Starting point of this work was the checklist of Italian macrophytobenthos (Furnari *et al.*, 2003); the checklists of Mediterranean seaweeds (Ribera *et al.*, 1992; Gallardo *et al.*, 1993; Gomez Garreta *et al.*, 2001) and the webpage ALGABASE (Guiry, M.D. and Nic Dhonncha E., 2003) were also consulted in order to assess a preliminary comparison between historical and recent data. The nomenclature and the chorological elements used in the present work follow the checklist of Italian macrophytobenthos (Furnari *et al.*, 2003).

RESULTS

In the list obtained, representative of the Ligurian flora from 1950 at the actual state of knowledge, 243 entities (241 species and 3 varieties) are enumerated. Rhodophyta are in the number of 151, Phaeophyta 44 and Chlorophyta 48.

54 of the listed entities are inedited quotations for Liguria and 35 are not even reported in the list of the adjacent Tuscany region, where phycological studies have been continuous in time and 408 taxa at the species level have been recorded (Furnari *et al.*, 2003). Finally 7 of the above listed species are introduced, according to Verlaque, 1993. In the following list, only comprehensive of the new records for Liguria (127 entities), each taxa is presented, together with the following details:

- the chorological element, following Furnari *et al.*, 2003 (C=Cosmopolitan, SC=Sub-cosmopolitan, A=Atlantic; AP=Atlantic-Pacific; IA=Indo-Atlantic; IP=Indo-Pacific; Ab=Atlantic-boreal; APTF=Atlantic-Pacific temperate cold; IATf=Indo-Atlantic temperate cold; CB=Circumboreal; CBA=Circumboreo-austral; P=Pantropical; Abt=Atlantic boreo-tropical; APT=Atlantic-Pacific tropical; At=Atlantic-tropical; IAt=Indo-Atlantic tropical)
- the source of record (!=personal communication of the present authors; T1=Tortonese, 1958; T2=Tortonese, 1961; T3=Tortonese, 1962; R=Relini *et al.*, 1986; B=Balduzzi *et al.*, 1992; C=Cattaneo-Vietti *et al.*, 2002; HbM=Herbarium Mangialajo; GE= Herbarium University of Genoa; GDOR=Herbarium Natural History Museum "G. Doria", Genoa).

Rhodophyta

Acrosorium venulosum (Zanardini) Kylin IA ! HbM GE (sub *A. uncinatum*)

Acrosymphyton purpuriferum (J. Agardh) G. Sjöstedt M ! GDOR T1

Acrothamnion preissii (Sonder) E. M. Wollaston IP ! HbM

Anotrichium tenue (C. Agardh) Nägeli IP !

Asparagopsis armata Harvey C C (sub *Falkenbergia rufolanosa*)

Bonnemaisonia asparagoides (Woodward) C. Agardh Ab ! HbM

Bornetia secundiflora (J. Agardh) Thuret Ab ! HbM GE GDOR

Botryocladia botryoides (Wulfen) Feldmann IA ! C

Callithamnion granulatum (Ducluzeau) C. Agardh IA ! HbM

Caulacanthus ustulatus (Turner) Kützing SC !

Ceramium ciliatum (J. Ellis) Ducluzeau v. *ciliatum* AP ! HbM GE

Ceramium circinatum (Kützing) J. Agardh IA !

Ceramium codii (H. Richards) Feldmann-Mazoyer SC !

Ceramium diaphanum (Lightfoot) Roth SC !
Ceramium rubrum auctorum SC ! GE GDOR C *Champia parvula* (C. Agardh) Harvey C !
Chondracanthus acicularis (Roth) Fredericq C ! GE (sub *Gigartina acicularis*) R (sub *G. acicularis*)
Chondria boryana (J. Agardh) De Toni M !
Chondria dasyphylla (Woodward) C. Agardh SC ! GDOR T1 R
Chondrophycus papillosus (C. Agardh) Garbary et Harper C ! R (sub *Laurencia papillosa*)
Chrysiomenia ventricosa (J.V. Lamouroux) J. Agardh At GDOR T1
Contarinia squamariae (Meneghini) Denizot M ! GDOR (sub *Rhizophyllis squamariae*)
T1 (sub *R. squamariae*)
Crouania attenuata (C. Agardh) J. Agardh SC !
Cryptonemia lomation (A. Bertloni) J. Agardh IA GE
Dasya corymbifera J. Agardh Abt !
Digenea simplex (Wulfen) C. Agardh P ! HbM GE
Fauchaea repens (C. Agardh) Montagne et Bory IA ! GDOR T1
Feldmannophycus rayssiae (Feldmann et Feldmann-Mazoyer) H. Augier et Bououresque M !
Gastroclonium clavatum (Roth) Ardissonne Ab ! HbM
Gelidium crinale (Turner) Gaillon SC !
Gelidium pusillum (Stackhouse) Le Jolis SC !
Gelidium spathulatum (Kützing) Bornet Ab !
Gelidium spinosum (S. G. Melin) P. C. Silva SC ! HbM GDOR (sub *G. corneum* v. *tricuspidatum*)
Gracilariopsis longissima (S.G. Gmelin) Steentoft, L. M. Irvine et Farnham C GDOR (sub *Gracilaria confervoides*)
Grateloupia dichotoma J. Agardh Abt !
Grateloupia filicina (J.V. Lamouroux) C. Agardh SC !
Griffithsia opuntioides J. Agardh IA GE
Halopithys incurva (Hudson) Batters IA ! GE (sub *H. pinastroides*) R
Herposiphonia secunda (C. Agardh) Ambronn P !
Hildenbrandia rubra (Sommerfelt) Meneghini SC !
Hypnea musciformis (Wulfen) J.V. Lamouroux P ! HbM GE GDOR C
Hypnea spinella (C. Agardh) Kützing P !
Kallymenia requienii J. Agardh Abt GDOR T1
Laurencia obtusa (Hudson) J.V. Lamouroux C ! GDOR C
Liagora distenta (Mertens ex Roth) J.V. Lamouroux SC ! GDOR T1
Nemalion helmintoides (Valley) Batters SC ! GDOR R
Nithophyllum punctatum Ardissonne IA ! HbM GE (sub *N. punctatum* v. *ocellatum*) GDOR
Osmundaria volubilis (Linnaeus) R.E. Norris IA ! GDOR (sub *Vidalia volubilis*) T1 (sub *V. volubilis*) T2 (sub *V. volubilis*) C
Osmundea truncata (Kützing) K.W. Nam et Maggs Ab !
Osmundea verlaquei G. Furnari M !
Peyssonnelia coriacea Feldmann M C
Peyssonnelia rosa-marina Boudouresque et Denizot M HbM C

- Phyllophora crispa* (Hudson) P.S. Dixon Ab ! GDOR (*sub P. nervosa*) T1 (*sub P. nervosa*) T2 (*sub P. nervosa*)
- Plocamium cartilagineum* (Linnaeus) P.S. Dixon SC ! HbM GDOR (*sub P. coccineum* v. *uncinatum*)
- Polysiphonia opaca* (C. Agardh) Moris et De Notaris Ab !
- Porphyra leucosticta* Thuret A ! GDOR (*sub P. atropurpurea*)
- Porphyra linearis* Greville A ! HbM
- Pterocliadiella capillacea* (S.G. Gmelin) Santelices et Hommersand SC ! HbM GE (*sub Pterocliadia pinnata*) GDOR (*sub P. pinnata*) T1 (*sub P. pinnata*) T2 (*sub P. pinnata*) C
- Pterosiphonia pennata* (C. Agardh) Sauvageau SC !
- Rhodophyllis divaricata* (Stackhouse) Papenfuss Ab ! C
- Rhodymenia pseudopalmata* (J.V. Lamouroux) P. C. Silva Abt !
- Rissoella verruculosa* (A. Bertoloni) J. Agardh M ! HbM GE GDOR
- Rytiphloea tinctoria* (Clemente) C. Agardh IA ! GDOR T2
- Schottera nicaeensis* (J.V. Lamouroux ex Duby) Guiry et Hollenberg IA ! HbM
- Sebdenia dichotoma* Berthold M ! C
- Sphaerococcus coronopifolius* Stackhouse Ab ! HbM GDOR T1 T2 R (*sub S. coronopifolius*) C
- Sphondylothamnion multifidum* (Hudson) Nägeli Ab ! HbM GDOR
- Tricleocarpa fragilis* (Linnaeus) Huisman & R.A. Townsend P ! HbM GDOR (*sub Galaxaura oblongata*) T1 (*sub G. oblongata*) B (*sub G. oblongata*) C
- Wrangelia penicillata* (C. Agardh) C. Agardh P ! GDOR T1 T2

Phaeophyta

- Arthrocladia villosa* (Hudson) Duby Ab !
- Carpomitra costata* (Stackhouse) Batters Aptf !
- Colpomenia sinuosa* (Mertens ex Roth) Derbes et Solier C ! GE GDOR T1 T2 R
- Cutleria multifida* (J.E. Smith) Greville SC ! C
- Cystoseira amentacea* (C. Agardh) Bory v. *stricta* Montagne M ! HbM GE (*sub C. stricta*) GDOR (*sub C. stricta*) T1 (*sub C. stricta*) T2 (*sub C. stricta*) T3 (*sub C. stricta*) B (*sub C. stricta*)
- Cystoseira brachycarpa* J. Agardh emend. Giaccone M !
- Cystoseira compressa* (Esper) Gerloff et Nizamuddin Ab ! GE (*sub C. fimbriata*) B (*sub C. compressa*)
- Cystoseira foeniculacea* (Linnaeus) Greville M R (*sub C. discors*)
- Cystoseira mediterranea* Sauvageau M ! T1 (*sub C. ericoides*)
- Cystoseira spinosa* Sauvageau M B C
- Cystoseira zosteroides* C. Agardh IP ! HbM T1 (*sub C. opuntioides*) B
- Dictyota dichotoma* (Hudson) J.V. Lamouroux v. *intricata* (C. Agardh) Greville SC ! HbM GDOR (*sub D. dichotoma* var. *implexa*) T1 (*sub D. dichotoma* v. *implexa*)
- Dictyota fasciola* (Roth) J. V. Lamouroux SC ! GDOR (*sub Dilophus fasciola*) T1 (*sub D. fasciola*) T2 (*sub D. fasciola*) C
- Dictyota spiralis* Montagne A GE (*sub Dilophus ligulatus*)

Dictyota linearis (C. Agardh) Greville SC C
Hydroclathrus clathratus (Bory ex C. Agardh) M. Howe C C
Liebmannia leveillei J. Agardh Abt ! HbM
Nereia filiformis (J. Agardh) Zanardini At !
Padina pavonica (Linnaeus) J.V. Lamouroux P ! GDOR (sub *P. pavonia*) T1 (sub *P. pavonia*) T2 (sub *P. pavonia*) T3 (sub *P. pavonia*) R B C
Petalonia fascia (O. F. Müller) Kuntze C GE
Ralfsia verrucosa (Areschoug) Areschoug SC ! T1
Sargassum hornschuchii C. Agardh M GE
Sargassum vulgare C. Agardh P ! HbM GDOR (sub *S. vulgare* v. *megalophyllum*) T1 (sub *S. vulgare* v. *megalophyllum*)
Scytosiphon lomentaria (Lyngbye) Link C ! HbM GDOR (sub *S. lomentarius*)
Sphacelaria rigidula Kützing C !
Sporochnus pedunculatus Hudson (C. Agardh) Ap !
Stypocaulon scoparium (Linnaeus) Kützing SC ! GE (sub *Halopteris scoparia*) GDOR (sub *H. scoparia*) T2 (sub *H. scoparia*) R B C (sub *H. scoparia*)
Taonia atomaria (Woodward) J. Agardh IA ! HbM GDOR C

Chlorophyta

Bryopsis cupressina J.V. Lamouroux M !
Bryopsis muscosa J.V. Lamouroux P ! HbM
Bryopsis plumosa (Hudson) C. Agardh SC C
Caulerpa prolifera (Forsskål) J.V. Lamouroux P ! GDOR T1 T3
Caulerpa racemosa (Forsskål) J. Agardh P ! HbM
Chaetomorpha mediterranea (Kützing) Kützing v. *crispa* (Feldmann) Gallardo et al. Ab GDOR (sub *C. capillaris* v. *crispa*) T1 (sub *C. capillaris*) T3 (sub *C. capillaris*)
Cladophora coelotrix Kützing IA !
Cladophora echinus (Biasoletto) Kützing IA ! R
Cladophora lehmanniana (Lindenberg) Kützing IA !
Cladophora pellucida (Hudson) Kützing IA GE
Cladophora ruchingeri (C. Agardh) Kützing Ab GDOR T1 T3
Cladophora socialis Kützing IA !
Codium bursa (Linnaeus) C. Agardh Abt ! HbM GDOR T1 T2 R B C
Codium decortcatum (Woodward) M. Howe IA ! GDOR
Codium effusum (Rafinesque) Delle Chiaje IP ! B (sub *C. adhaerens*)
Codium fragile (Suringar) Hariot ssp. *tomentosoides* (Goor) P.C. Silva A !
Codium vermilara (Olivi) Delle Chiaje At ! GE GDOR R (sub *C. dichotomum*)
Dasycladus vermicularis (Scopoli) Krasser At ! B
Derbesia tenuissima (Moris et De Notaris) P. et H. Crouan SC !
Flabellia petiolata (Turra) Nizamuddin At ! HbM GDOR (sub *Udotea petiolata*) T1 (sub *U. petiolata*) T2 (sub *U. petiolata*) R (sub *U. petiolata*) B C (sub *U. petiolata*)
Halimeda tuna (J. Ellis et Solander) J. V. Lamouroux P ! HbM GDOR T1 T2 R B C
Pedobesia simplex (Meneghini ex Kützing) M. J. Wynne et Leliaert CB GE (sub *Derbesia*

- Iamourouxii*) GDOR (sub *Bryopsis balbisiana*)
- Penicillus capitatus* Lamarck At B
- Pseudochlorodesmis furcellata* (Zanardini) Børgesen v. *furcellata* Abt !
- Rhizoclonium tortuosum* (Dillwyn) Kützing SC GDOR
- Ulva intestinalis* Linnaeus C ! HbM R
- Ulva laetevirens* Areschoug C ! HbM GE (sub *U. lactuca*) T3 (sub *U. lactuca*)
- Ulva linza* Linnaeus C !
- Valonia macrophysa* Kützing P C
- Valonia utricularis* (Roth) C. Agardh P ! HbM T

Fucus vesiculosus Linnaeus and *F. spiralis* Linnaeus, found in 1996 in Liguria (Albisola M., SV), are not included: they were probably discarded by human activity (recreational fishing). It's worth stressing that exactly in the same locality, *F. vesiculosus* was found, apparently settled, by Piccone at the end of 19th century (1889; 1891).

The chorological spectrum of the actual list of Ligurian macrophytobenthos is showed in Fig. 2A. The cosmopolitan and sub-cosmopolitan elements dominate (C+SC=30,3%), with entities characterized by wide distribution (A+AP+IA+IP=23,0%). Elements with warm affinities are more important (P+Abt+APt+At+IA=19,3%) than the ones with cold affinities (Ab+APtf+IAtf+CB+CBA=16,0%). The Mediterranean component (M) accounts for the 11,2%.

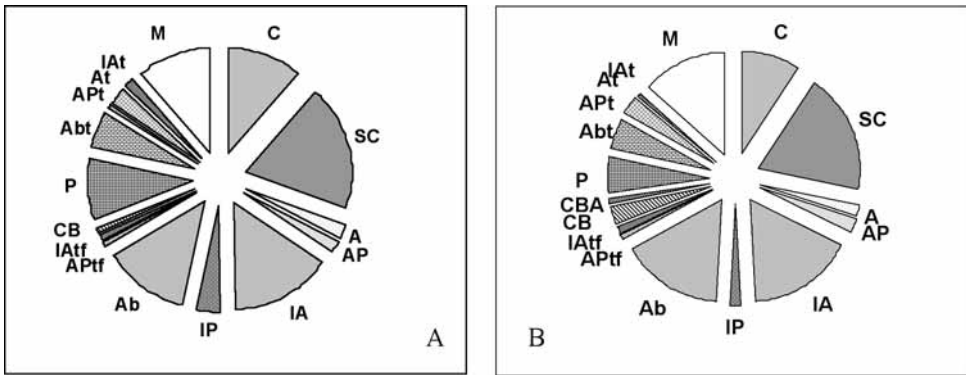

Fig. 2: A) Actual Chorological spectrum. B) Historical Chorological spectrum.

Data in literature before 1950 enumerate 351 taxa. Of these 208 have not been recorded in the last 53 years, but 77 of them are dubious. The chorological spectrum, excluding dubious taxa, is showed in Figure 2B: elements with very large distribution dominate (28,3% and 22,4%); elements with warm affinities are lower than the ones with cold affinities (respectively 14,2% and 21,7%). The Mediterranean component is 13,4%. In Tab. 1 the trend of each divisio is showed.

Tab 1: Percentage values of chorological elements for each division

	Rhodophyta		Phaeophyta		Chlorophyta	
	Lig. 2003	Lig. 1950	Lig. 2003	Lig. 1950	Lig. 2003	Lig. 1950
number of entities	151	177	44	54	48	43
Cosmopolitans (C+SC)	27,8	23,9	42,2	35,3	27,1	37,5
Wide distribution (A+AP+IA+IP)	23,2	22,7	17,8	17,6	27,1	27,5
Cold affinities (Ab+APtf+IAtf+CB+CBA)	19,2	26,4	11,1	19,6	10,4	5,0
Warm affinities (P+Abt+APt+At+IAt)	17,9	14,1	11,1	7,8	31,3	22,5
Mediterranean	11,9	12,9	17,8	19,6	4,2	7,5

DISCUSSION AND CONCLUSION

An inversion of the trend is observed in the chorological spectra. In fact, in the historical data, cold affinity elements are more important than the warm ones, while the actual list shows an opposite trend (Fig. 2), except for Chlorophyta, where both warm and cold-affinity elements increase (Tab. 1).

The present work seems to confirm the popular theory of Mediterranean Sea warming, at least for Liguria, typically one of the colder regions in the basin. Unluckily, this bulk of data, is very far to be exhaustive, both for what concerns the research of taxa to be included in the actual list, and for the taxonomical problems within the historical data. More time and energies will be necessary to achieve a representative list of Ligurian macrophytobenthos, in order to make a more accurate comparison with the other regions of Mediterranean Sea.

ACKNOWLEDGEMENTS

The authors wish to thank Prof. E. Paola and Gilles Passeron for the help on the field, Dr. E. Ballesteros and C. Rodriguez for the help with determination and Dr. R. Poggi, Director of the N.H.M. of Genoa.

REFERENCES

- Ardissone F. (1883) - Phycologia Mediterranea. Parte Prima. Floridee. *Mem. Soc. Crittog. Ital.*, 1: 1-516.
- Ardissone F. (1886) - Phycologia Mediterranea. Parte Seconda. Oosporee-Zoosporee-Schizosporee. *Mem. Soc. Crittog. Ital.*, 2: 1-325.
- Ardissone F., Strafforello J. (1877) - *Enumerazione delle alghe di Liguria*. Ed. Lombarda, Milano. 238pp.
- Balduzzi A., Bianchi C. N., Cattaneo-Vietti R., Cerrano C., Cocito S., Cotta S., Degl'innocenti F., Diviacco G., Morgigni M., Morri C., Pansini M., Salvatori L., Senes L., Sgorbini S., Tunesi L. (1993) - Primi lineamenti di bionomia bentica dell'Isola Gallinaria (Mar Ligure). *Atti del 10° Congr. A.I.O.L., Allassio, 4-6- Nov. 1992*: 603-617.

- Cattaneo-Vietti R., Albertelli G., Bavestrello G., Bianchi C. N., Cerrano C., Chiantore M., Gaggero L., Morri C., Schiaparelli S. (2002) - Can rock composition affect sublittoral epibenthic communities? *Mar. Ecol.*, 23 (1): 65-77.
- Furnari G., Giaccone G., Cormaci M., Alongi G., Serio D. (2003) - Biodiversità marina delle coste italiane: catalogo del macrofitobenthos. *Biologia Marina Mediterranea*, 10 (1): 1-482.
- Gallardo T., Gomez-Garreta A., Ribera M. A., Cormaci M., Furnari G., Giaccone G., Boudouresque C. F. (1993) – Check-list of Mediterranean Seaweeds. II Chlorophyceae *Wille s. l. Bot. Mar.*, 36: 399-421.
- Gomez Garreta A., Gallardo T., Ribera M. A., Cormaci M., Furnari G., Giaccone G., Boudouresque C. F. (2001) – Checklist of Mediterranean Seaweeds. III Rhodophyceae Rabenh 1. Ceramiales Oltn. *Bot. Mar.*, 44: 425-460.
- Guiry M.D., Nic Dhonncha E. (2003) - *AlgaeBase version 2.0*. World-wide electronic publication, National University of Ireland, Galway. <http://www.algaebase.org>.
- Piccone A. (1885) - Nuove spigolature per la ficologia ligustica. *Notarisia* 3: 437-443.
- Piccone A. (1889) - Noterelle ficologiche. I. Il *Fucus vesiculosus* L. vive spontaneo in Liguria? *Notarisia* 3: 437-443.
- Piccone A. (1891) – Noterelle ficologiche. VIII. Nuovi dati intorno alla questione se il *Fucus vesiculosus* L. cresce in Liguria. *Nuova Notarisia* 1: 350-352.
- Preda A. (1904) - Primo contributo alla flora algologica del golfo della Spezia: *Floridee. Malpighia* 28: 59-69.
- Preda A. (1917) - Flora algologica del golfo della Spezia. Secondo contributo. *Nuova notarisia* 18: 76-93.
- Relini G., Ardizzone G. D., Belluscio A. (1986) - Le biocenosi bentoniche costiere delle Cinque Terre (Mar Ligure Orientale). *Boll. Mus. Ist. Biol. Univ. Genova* 52 suppl.: 163-195.
- Ribera M. A., Gomez-Garreta A., Gallardo T., Cormaci M., Furnari G., Giaccone G. (1992) – Check-list of Mediterranean Seaweeds. I Fucophyceae (Warming, 1884). *Bot. Mar.*, 35: 109-130.
- Tortonese E. (1958) - Bionomia marina della regione costiera fra Punta della Chiappa e Portofino. *Arch. Ocean. Limnol.*, 11: 167-210.
- Tortonese E. (1961) - Nuovo contributo alla conoscenza del benthos della scogliera ligure. *Arch. Ocean. Limnol.*, 12 (2): 164-183.
- Tortonese E. (1962) - Recenti ricerche sul bentos in ambienti litorali del Mar Ligure. *Pubbl. Staz. Zool. Napoli*, 32 (suppl.): 99-116.
- Tosco U. (1958) - Contributo alla conoscenza della flora delle "Cinque Terre", Liguria di Levante. I. Le Alghe. *Ann. Mus. Civico Storia Nat. Genova* 70 : 1-7
- Verlaque M. (1993) - Inventaire des plantes introduites en Méditerranée: origine et répercussion sur l'environnement et les activités humaines. *Oceanologica acta* 17 (1): 1-23.
- Vinassa P. E. (1891a) - Contribuzione alla ficologia ligustica. *Atti Soc. Tosc. Sci. Nat. Pisa Processi Verballi*, 8 Marzo: 219-230.
- Vinassa P. E. (1891 b) - Seconda contribuzione alla ficologia ligustica. *Atti Soc. Tosc. Sci. Nat. Pisa Processi Verballi*, 15 Novembre: 14-23.

APPARITION DE LA PHANEROGAME *HALOPHILA STIPULACEA* DANS LE GOLFE DE GABES (TUNISIE)

Héchmi MISSAOUI¹ *, Mohamed Sofière MAHJOUB² et Mohamed CHALGHAF²

¹ Institut Supérieur de Pêche et d'Aquaculture, ISPA, Bizerte 7080 TUNISIE

² Institut National Agronomique de Tunisie, 43 rue Charles Nicole 1082 Tunis TUNISIE

* missaoui.hechmi@inat.agrinet.tn

RESUME

Ce travail signale la première apparition de la phanérogame marine *Halophila stipulacea* (Forsskål) Ascherson (Hydrocharitaceae) dans les eaux tunisiennes. Cette espèce colonise les fonds vaseux proches de 5 m de profondeur en face du port de pêche de Sfax.

L'identification de la macrofaune et de la macroflore associées à ce spermaphyte montre la présence de 45 espèces.

Certains paramètres phénologiques sont traités.

KEY WORDS: First apparition – Phanerogam – *Halophila stipulacea* – Gulf of Gabes- Tunisia.

INTRODUCTION

Depuis l'ouverture du canal de Suez en 1869 plusieurs espèces d'origine indopacifique ont fait leur apparition en Tunisie notamment dans le golfe de Gabès. Parmi les espèces les plus abondantes on note : le bivalve *Pinctada radiata* (Leach, 1814), le poisson *Stephanolepis diaspros* (Fraser-Brunner, 1940) et les crustacés décapodes *Eucrete crenata* De Haan, 1835, *Metapenaeus monoceros* (Fabricius, 1798) et *Trachysalambria palaestinensis* (Steinitz, 1932).

La Phanérogame marine *Halophila stipulacea* (Forsskål) Ascherson (Hydrocharitaceae), considérée comme introduite (Boudouresque and Verlaque 2002), a été signalée en Méditerranée orientale dès la fin du XIX^{ème} siècle et en Méditerranée occidentale dès 1995 (Acunto *et al.* 1995). Cette espèce a été rencontrée en grand nombre sur les filets de pêche des barques opérant dans les faibles profondeurs de la région de Sfax (Tunisie).

Ce travail signale la présence d'*Halophila stipulacea* sur les côtes tunisiennes et donne des informations préliminaires sur la macrofaune et la macroflore associées à cette espèce. Quelques paramètres phénologiques sont traités.

MATERIELS Et METHODES

Nous avons prélevé les échantillons d'*Halophila stipulacea* et des espèces qui leurs sont associées sur les filets des pêcheurs ainsi que par plongée en apnée entre 7 et 8 m de profondeur, en octobre 2003. Ces échantillons ont été conservés au formol (5%).

Les paramètres suivants : longueur du limbe (i), largeur de la feuille (ii) et longueur des inter-nœuds (iii) sur le rhizome ont été mesurés (Fig. 1).

RESULTATS

Identification de l'espèce et phénologie

L'espèce présente un rhizome portant au niveau de chaque nœud une seule racine. Les feuilles sont aplaties, ovales et allongées. Elles sont pourvues de trois nervures : une centrale et deux marginales et leurs bords sont denticulés. Ces critères permettent de confirmer selon les descriptions de Riedl *et al.* (1991) que nous sommes en présence de l'espèce *Halophila stipulacea* (Forsskål) (Hydrocharitaceae).

La longueur du limbe et la largeur des feuilles varient respectivement de 23,2 mm à 65,2 mm (Longueur moyenne : $44 \pm 1,5$ mm) et de 6 mm à 10,5 mm (Largeur moyenne : $7,6 \pm 0,1$ mm). La longueur moyenne de l'inter-nœud sur le rhizome varie entre 2,2 mm et 20,9 mm (Longueur moyenne : $12,7 \pm 0,7$ mm).

Par ailleurs, lors de l'observation des feuilles d'*Halophila stipulacea*, nous avons remarqué que plusieurs d'entre elles montraient des traces de broutage (Fig. 2). Ceci indique que cette espèce fait partie du régime alimentaire de certains animaux benthiques.

Macrofaune et macroflore associées

L'identification de la macrofaune et de la macroflore associées à *Halophila stipulacea* a révélé l'existence de 45 espèces appartenant à 31 familles différentes.

Algues et phanérogames marines

Caulerpaceae *Caulerpa prolifera* (Forsskål) Lamouroux, 1809, Ulvaceae *Ulva sp.*, Udoteaceae *Halimeda tuna* (Ellis et Solander) Lamouroux, 1824, Codiaceae *Codium bursa* (Linnaeus) Kützing, 1822, *Codium vermilara* (Olivi) Delle Chiaje, 1829, Potamogetonaceae *Posidonia oceanica* (Linnaeus) Delile, 1813, *Cymodocea nodosa* (Ucria) Ascherson, Kallymeniaceae *Kallymenia sp.* et Gelidiaceae *Pterocladia sp.*

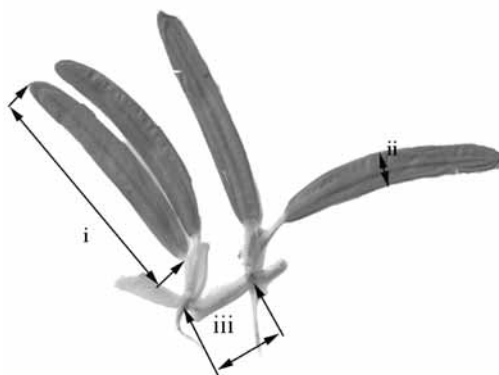

Fig. 1 Mesurations sur *H. stipulacea*



Fig. 2 : Traces de broutage sur *H. stipulacea*

Invertébrés

Styelidae *Styela plicata* (Lesueur, 1823), Pyuridae *Microcosmus* sp. Pinnidae *Pinna nobilis* Linnaeus, 1758, Pteriidae *Pinctada radiata* (Leach, 1814), Sepiidae *Sepia officinalis* Linnaeus, 1758, Balanidae *Balanus* sp., Goneplacidae *Eucrate crenata* De Haan, 1835, Majidae *Libinia dubia* H. Milne Edwards, 1834 et *Maja verrucosa* H. Milne Edwards, 1834, Penaeidae *Penaeus kerathurus* (Forsskål, 1775) et *Trachysalambria palaestinensis* (Steinitz, 1932), Palaemonidae *Palaemon adspersus* Rathke, 1837, Portunidae *Carcinus aestuarii* Nardo, 1847, Squillidae *Squilla mantis* (Linnaeus, 1758), Echinidae *Paracentrotus lividus* Lamarck, 1816, Cypraeidae *Erosaria* sp., Holothuriidae *Holothuria* sp.

Vertébrés

Anguillidae *Anguilla anguilla* (Linnaeus, 1758), Dasyatidae *Dasyatis* sp., Blenniidae *Salaria basilisca* (Valenciennes, 1836), Engraulididae *Engraulis encrasicolus* (Linnaeus, 1758), Labridae *Labrus viridis* Linnaeus, 1758, Monacanthidae *Stephanolepis diaspros* (Fraser-Brunner, 1940), Mugilidae *Liza aurata* (Risso, 1810), Mullidae *Mullus surmeletus* Linnaeus, 1758, Sciaenidae *Sciaena umbra* Linnaeus, 1758, Soleidae *Solea* sp., Sparidae *Dentex dentex* (Linnaeus, 1758), *Diplodus annularis* (Linnaeus, 1758), *D. vulgaris* (Geoffroy St.-Hilaire, 1817), *Lithognathus mormyrus* (Linnaeus, 1758), *Sarpa salpa* (Linnaeus, 1758) et *Sparus auratus* Linnaeus, 1758, Syngnathidae *Hippocampus hippocampus* (Linnaeus, 1758).

CONCLUSION

L'expansion de la phanérogame marine *Halophila stipulacea* vers l'ouest de la Méditerranée a atteint le golfe de Gabès en Tunisie. Ceci confirme, une fois de plus, l'adaptation des espèces lessepsiennes aux conditions hydrologiques de la Tunisie méridionale. Le manque de données sur l'impact de ces espèces sur les populations autochtones tunisiennes nous pousse à approfondir les recherches.

REFERENCES

- Acunto S., Maltagliati F., Rindi F., Rossi F., Cinelli F. (1995) - Osservazioni su una prateria di *Halophila stipulacea* (Forssk.) Aschers. (Hydrocharitaceae) nel mar Tirreno meridionale. *Atti Soc. Tosc. Sci. Nat.*, Mem., Serie B, 102: 19-22.
- Boudouresque C.F., Verlaque M. (2002) - Biological pollution in the Mediterranean Sea: invasive versus introduced species. *Mar.Pollut. Bull.*, 44 (1): 32-38.
- Riedl R. (1991) - *Fauna e flora del Mediterraneo*. Franco Muzzio Editore: 777 pp.

SESSION 'MAPPING MARINE
VEGETATION DISTRIBUTION'

*SESSION CARTOGRAPHIE DE LA
REPARTITION DE LA VEGETATION
MARINE*

CARTOGRAPHIE DE LA PRAIRIE A *POSIDONIA OCEANICA* ET DES PRINCIPAUX FACIES SEDIMENTAIRES MARINS DU PARC NATIONAL DE PORT-CROS (VAR, FRANCE, MEDITERRANEE)

Thomas BELSHER¹, Eric HOULGATTE² et Charles François BOUDOURESQUE³

¹ Ifremer, Avenue Jean Monnet, BP.171, 34203 Sète, FRANCE

² Bureau de Géologie, 12 rue Amiral Linnois, 29200 Brest, FRANCE

³ UMR 6540 Dimar, Centre d'Océanologie de Marseille, campus de Luminy, 13288 Marseille cedex 9, FRANCE

RESUME

La carte a été établie au moyen du sonar latéral, d'une caméra vidéo remorquée, de prélèvements à la benne, de plongées en scaphandre autonome et de photographies aériennes. Le peuplement le plus étendu est la prairie à *Posidonia oceanica*. Les divers faciès sédimentaires correspondant au Détritique Côtier sont également bien représentés. Bien que la prairie à *P. oceanica* semble en bon état, des traces de dégradation, sans doute attribuables à l'ancrage de navires, ont été mises en évidence dans la passe entre Port-Cros et Bagaud.

ABSTRACT

The map was established from data of side scan sonar, trawling camera, crab samples, skin-diving observations and aerial photography. The most extensive population is that of *Posidonia oceanica*. Sedimentary elements, classified in «Détritique Côtier», also cover a large part of the submarine area. While, in general, *Posidonia oceanica* beds appear in good health, signs of degradation appear, due of vessels, are observed in the channel between Port-Cros and Bagaud Island.

INTRODUCTION

La cartographie des peuplements benthiques et des types de fond constitue un outil essentiel pour la gestion des espaces littoraux (Meinesz *et al.*, 1991 ; Pasqualini, 1997 ; Pasqualini *et al.*, 1998, 2000). Ceci est tout particulièrement vrai pour ce qui concerne (i) d'une part la prairie à *Posidonia oceanica* (Linnaeus) Delile (Magnoliophyte, Plantae), espèce protégée en France, inscrite sur les Annexes des Conventions de Berne et de Barcelone et habitat prioritaire de la "Directive Habitats" de l'Union Européenne, (ii) d'autre part une Aire Marine Protégée, le Parc national de Port-Cros (Bougeant, 1990 ; Pergent, 1991 ; Boudouresque *et al.*, 1994, 1996).

La carte des peuplements et des types de fond permet au gestionnaire d'organiser le zonage des usages (plongée, navigation de plaisance, ancrage, pêche amateur et professionnelle) en fonction des types d'habitats et de leur sensibilité (Arata et Lombardi,

1984 ; Politano, 1992 ; Ramos-Esplá et McNeill, 1994 ; Boudouresque, 2002 ; Boudouresque *et al.*, 2004, 2005). En cas d'invasions biologiques, par exemple l'introduction des Chlorobiontes (Plantae) *Caulerpa taxifolia* (Vahl) C. Agardh et *C. racemosa* (Forsskål) J. Agardh var. *cylindracea* (Sonder) Verlaque, Huisman et Boudouresque (Verlaque *et al.*, 2000 ; Meinesz *et al.*, 2001), elle permet d'identifier les habitats les plus susceptibles à la colonisation et d'y concentrer la surveillance (Belsher et Houlgatte, 2000). Enfin, la comparaison de cartes successives permet de valider, ou non, les mesures de gestion.

A Port-Cros (Var, France, Méditerranée), quelques cartes des peuplements benthiques ont été réalisées, généralement avec des techniques anciennes et un positionnement approximatif ; elles concernent principalement la prairie à *Posidonia oceanica* et les petits fonds et ne couvrent qu'une petite partie du Parc national (Molinier et Picard, 1952 ; Augier et Boudouresque, 1967, 1970a, 1970b, 1976 ; Augier et Niéri, 1988 ; Bellone et Meinesz, 1995 ; Loquès *et al.*, 1995). Bourcier (1982) a cartographié quelques faciès de Détritique Côtier et Pérès et Picard (1963) ont présenté une carte à très petite échelle de l'ensemble des fonds entourant Port-Cros. Il existe également une carte inédite des fonds marins de Port-Cros, basée sur des observations en plongée sous-marine (Philippe Tailliez et collaborateurs) et des tentatives de synthèse à très petite échelle des prairies à *Posidonia oceanica* (Blanc, 1975 ; Giraud, 1980 ; Astier et Tailliez, 1984 ; Jeudy de Grissac *et al.*, 1985 ; Iehl *et al.* 1995).

Nous présentons ici une première carte de l'ensemble de la prairie à *Posidonia oceanica* ainsi que des principaux faciès sédimentaires du Parc national de Port-Cros, à partir de données originales. Celles-ci ont été interprétées et complétées, pour partie, grâce aux éléments cartographiques existants et à des observations inédites communiquées par les scientifiques qui ont plongé dans les eaux de Port-Cros.

MATERIEL ET METHODES

Les données originales ont été acquises en Juin 1999 lors d'une campagne du Navire Océanographique "L'Europe" (IFREMER/ICRAM), entre le niveau de la mer et 100 m de profondeur, au moyen d'un sonar latéral et d'une caméra vidéo remorquée. Des plongées en scaphandre autonome et des prélèvements à la benne ont permis de compléter et de faciliter l'interprétation de ces données. Enfin, des photographies aériennes (missions IGN 1978, 1980 et 1995) ont été utilisées. Les isobathes proviennent de la carte SHOM (Service Hydrographique de la Marine Nationale).

Le sonar latéral est constitué par un émetteur ("poisson"), trainé par un bateau (vitesse moyenne : 5 nœuds), qui émet des ondes courtes (inférieures à la milliseconde). Le signal est réfléchi par le fond, en fonction de sa nature, et est restitué sous la forme d'un sonogramme (résolution de l'ordre de 0.5 m). L'interprétation des sonogrammes a été validée grâce à la caméra vidéo remorquée, aux prélèvements à la benne et aux

plongées en scaphandre autonome, permettant ainsi de déterminer la morphologie et la nature du fond (Meinesz *et al.*, 1981 ; Berné *et al.*, 1986 ; Weber, 1989).

Grâce au logiciel de navigation Sodena, le parcours de la camera vidéo remorquée a été reconstitué. Comme pour le sonar latéral, les prélèvements à la benne et les plongées, le positionnement a été établi au moyen d'un GPS (Global Positioning System).

RESULTATS ET DISCUSSION

La topographie des fonds du Parc national de Port-Cros est variée. Des fonds rocheux, sableux ou grossiers (graviers et cailloux) ainsi que la prairie à *Posidonia oceanica* se répartissent en une mosaïque irrégulière mais néanmoins bien hiérarchisée, du fait d'un héritage tant géologique que biologique, dans un milieu soumis à un hydrodynamisme complexe (Fig. 1) Compte tenu du temps imparti à la présente étude, des techniques mises en œuvre et de l'ampleur de la carte à réaliser, nous avons fait le choix de regrouper des faciès qui ne sont pas strictement en rapport avec les étages, sous-étages et horizons définis par Pérès et Picard (1964).

Les peuplements de substrat dur de l'étage infralittoral (au sens de Pérès et Picard, 1964) ont été réunis sous le nom de "roches en place et blocs de natures indifférenciées" (Fig. 1). Les méthodes utilisées ne permettent en effet pas de les différencier, contrairement à ce qui a été fait, à une autre échelle et sur des secteurs limités, par Augier et Boudouresque (1967, 1970a, 1970b, 1976). Cette démarche permet d'éviter toute confusion avec des travaux détaillés, réalisés à très grande échelle (1/1 000 à 1/2 000) par des auteurs soucieux de réaliser une description rigoureuse de l'agencement des biocénoses benthiques, ce qui dépassait les objectifs de la présente étude.

Entre le niveau de la mer et 30-33 m de profondeur, dans l'étage infralittoral, le peuplement le plus étendu est la prairie à *Posidonia oceanica* (Fig. 1). La prairie est généralement dense ; ce n'est qu'en limite profonde, principalement dans la passe entre Port-Cros et Bagaud et très localement ailleurs (par exemple vers la pointe du Tuf), que la prairie se présente sous forme clairsemée. Harmelin et Laborel (1976) et Harmelin (1977) ont indiqué que la limite inférieure se situait entre 32 et 36 (38) m. Bien que la remontée de la limite inférieure de *P. oceanica* soit un phénomène général en Méditerranée nord-occidentale (Boudouresque *et al.*, 2000 ; Mayot *et al.*, 2005), il serait prématuré de conclure à un phénomène similaire à Port-Cros. En effet, les données des années 1970 et la carte actuelle ont été acquises avec des méthodes très différentes. En outre, au cours de l'acquisition des données par vidéo remorquée et plongée, en 1999, nous avons observé localement une limite inférieure à 38 m de profondeur, dans le secteur de la pointe du Vaisseau.

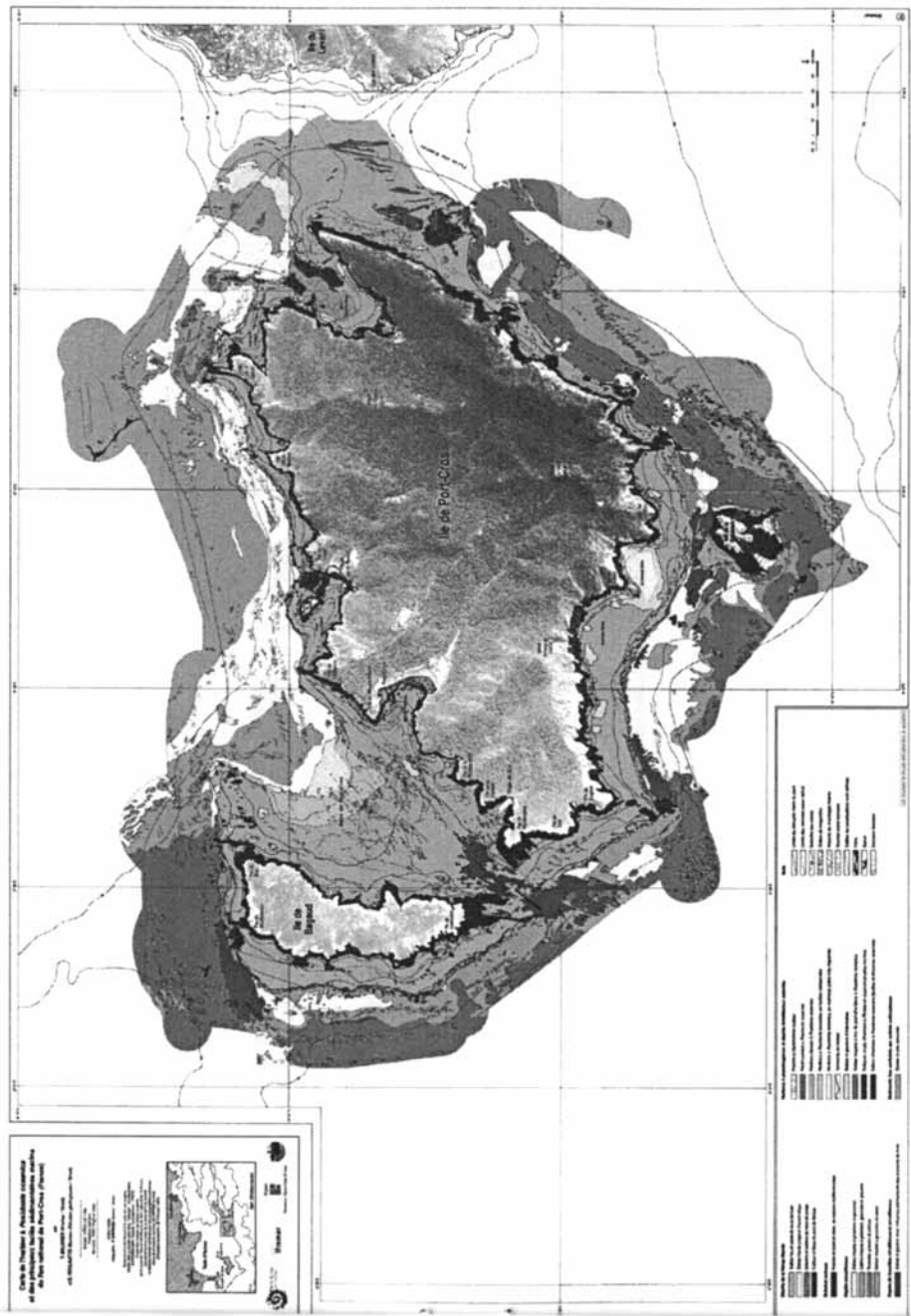

Dans les baies de Port-Man et de Port-Cros, les fonds que nous avons classés comme "sables et silts remaniés (sédiments perturbés par des actions anthropiques)" (Fig. 1) recouvrent en fait des mattes mortes de *P. oceanica* (Augier et Boudouresque, 1970a, 1970b ; Bellone et Meinesz, 1995), la mort de *P. oceanica* pouvant y dater de plusieurs siècles (Boudouresque *et al.*, 1980).

Dans la partie centrale de la passe entre Port-Cros et Bagaud, la prairie à *P. oceanica* est striée par de nombreuses traces que nous attribuons à l'ancrage (Fig. 1). Plusieurs auteurs ont mis en évidence, ou tenté de le faire, l'impact des ancrages sur la prairie à *P. oceanica* (Boudouresque *et al.*, 1995a ; Francour *et al.*, 1997, 1999 ; Ganteaume *et al.*, 2005a), en particulier celui des navires de fort tonnage (Roy *et al.*, 1999 ; Ganteaume *et al.*, 2005b). Nous remarquons que des traces attribuables aux ancres ne sont pas visibles sur les petits fonds situés devant la côte Est de Bagaud, aussi bien dans un secteur où l'ancrage est interdit depuis 1993 que dans ceux où il est autorisé ; la pression de mouillage y est toutefois relativement faible (Ganteaume *et al.*, 2005b) et il s'agit de petits bateaux. Dans le cas de la partie centrale de la passe entre Bagaud et Port-Cros, si les traces observées sont bien dues à des ancres, il pourrait s'agir de navires de fort tonnage.

Les peuplements de substrat meuble de l'Infralittoral ont été cartographiés (Fig. 1) en fonction de leur dominante granulométrique (sable fin, moyen, graviers, cailloux, blocs) et non des biocénoses définies par Pérès et Picard (1964). Un type de substrat meuble particulier a été considéré pour les étendues sableuses incluses dans la prairie à *Posidonia oceanica* ("sables d'intermattes"). Seule la biocénose des Sables et Graviers sous l'influence des Courants de Fonds (SGCF), d'ailleurs commune à l'Infralittoral et au Circalittoral (Pérès et Picard, 1964 ; Bellan-Santini *et al.*, 1994), a été distinguée.

Dans l'étage circalittoral, qui succède vers le bas à l'Infralittoral, comme dans ce dernier étage, les méthodes utilisées ne permettent pas de distinguer les biocénoses et les faciès de substrat meuble, et c'est donc la nature du substrat qui a été cartographiée (Fig. 1). Toutefois, on peut considérer que les "sables moyens à grossiers et granules", les "sables moyens à grossiers, granules et graviers" et les "granules, graviers et cailloux" correspondent à la biocénose du Détritique Côtier (Pérès et Picard, 1964 ; Bourcier, 1982 ; Bellan-Santini *et al.*, 1994).

Une biocénose circalittorale très importante, d'un point de vue patrimonial, le coralligène (Pérès et Picard, 1964 ; Bellan-Santini *et al.*, 1994 ; Boudouresque, 2004), n'a pas pu être individualisée sur notre carte (Fig. 1). En effet, elle se développe principalement sur des parois verticales, de telle sorte que la surface couverte, en projection cartographique, est négligeable.

La Chlorobionte (Plantae) introduite *Caulerpa taxifolia* a été observée dans la baie de Port-Man et à la pointe du Tuf (côte Est de Port-Cros ; vers 34 m de profondeur). Cette

espèce, originaire du Sud de l'Australie (Jousson *et al.*, 1998, 2000), constitue une menace pour le patrimoine biologique du Parc national de Port-Cros (Boudouresque *et al.*, 1995b ; Boudouresque, 1997 ; Romero, 1997 ; Meinesz *et al.*, 2001). Des campagnes d'arrachage sont donc réalisées chaque année, afin de limiter son expansion (Cottalorda *et al.*, 1996 ; Robert, 1996 ; Robert et Gravez, 1998 ; Robert, 2002). Une autre Chlorobionte introduite, *C. racemosa* var. *cylindracea*, est présente à Port-Cros (Robert, 2001). Dans les deux cas, les surfaces couvertes sont négligeables, à l'échelle de notre carte, et n'ont donc pu être représentées.

CONCLUSIONS

La carte des peuplements benthiques et faciès sédimentaires que nous présentons a été établie à partir de données originales (sonar latéral, caméra vidéo remorquée, prélèvements à la benne, plongées). Ces données ont été complétées par des photographies aériennes et par les cartes établies antérieurement, pour des secteurs particuliers ou à des échelles plus réduites.

Depuis la création du Parc national de Port-Cros, en 1963, le travail présenté ici constitue la première tentative de cartographie de l'ensemble des fonds marins de l'île. Toutefois, à l'exception de la prairie à *Posidonia oceanica* et des SGCF, cette carte ne figure pas des biocénoses, mais des faciès sédimentaires.

Néanmoins, cette carte fournit aux chercheurs qui travaillent à Port-Cros une base de travail. Elle a été mise sous système d'information géographique (SIG) et les différentes couches d'information ont été numérisées. Ces données, ainsi que la version papier de la carte au format A0, peuvent être consultées au Parc national de Port-Cros. Il appartient maintenant aux chercheurs qui travaillent dans les eaux du Parc national de les affiner et de les compléter, afin d'améliorer la carte que nous présentons. Celle-ci fournit dès à présent aux gestionnaires de la partie marine du Parc national un outil de décision plus précis que ceux dont ils disposaient jusqu'à maintenant.

REMERCIEMENTS

Les auteurs remercient le Ministère de l'Aménagement du Territoire et de l'Environnement (MATE) et le Parc National de Port-Cros (PNPC), qui ont co-financé cette étude, le Capitaine (Cdt P. Petipas) et l'équipage du Navire océanographique "L'Europe" (Ifremer/Icram) ainsi que les scientifiques, les techniciens et les personnels de l'Ifremer (V. Rigaud, J. Opderbecke, M. Sistiaga, S. Valestra, D. Sémac, D. Chenot, D. Clec'h, O. Dugornay, H. Goragner, E. Le Gall, M. Peleau), de Genavir (C. Prud'homme), du PNPC (P. Robert, M. Poulain), du LEML (Université de Nice), du GIS Posidonie (M. Verlaque) et de la Société ACSA (H. Thomas, PDG, X. Charles, P. Lagier), qui les ont aidés lors de la campagne d'acquisition des données ou pour l'interprétation de celles-ci, grâce à leur connaissance des fonds marins de Port-Cros.

REFERENCES

- Arata P., Lombardi P. (1984) - Considerazioni sulle riserve marine nel quadro della gestione della fascia cos-tiera. Pesca e Ambiente, 1 (1) : 3-65.
- Astier J.M., Tailliez P. (1984) - Pour un plan d'occupation des fonds marins : inventaire des herbiers de Posidonies du littoral du Var. Ann. Soc. Sci. Nat. Archéol. Toulon Var, 36 (1) : 35-46.
- Augier H., Boudouresque C.F. (1967) - Végétation marine de Port-Cros (Parc national). I. La baie de La Palu. Bull. Mus. Hist. nat. Marseille, 27: 93-124 + 1 pl. h.t.
- Augier H., Boudouresque C.F. (1970a) - Végétation marine de Port-Cros (Parc national). V. La baie de Port-Man et le problème de la régression de l'herbier de posidonies. Bull. Mus. Hist. nat. Marseille, 30: 145-164 + 1 pl. h.t.
- Augier H., Boudouresque C.F. (1970b) - Végétation marine de Port-Cros (Parc national). VI. Le récif barrière de posidonies de la baie de Port-Cros. Bull. Mus. Hist. nat. Marseille, 30: 221-228 + 1 carte h.t.
- Augier H., Boudouresque C.F. (1976) - Végétation marine de Port-Cros (Parc national). XIII. Documents pour la carte des peuplements benthiques. Trav. sci. Parc nation. Port-Cros, 2: 9-22 + 1 pl. h.t.
- Augier H., Niéri M. (1988) - Cartographie, balisage et dynamique du récifbarrière à *Posidonia oceanica* de la baie de Port-Cros (Parc national). Sci. Rep. Port-Cros natl. Park, 14: 29-40 + 1 pl. h.t.
- Bellan-Santini D., Lacaze J.C., Poizat C. (1994) - Les biocénoses marines et littorales de Méditerranée, synthèse, menaces et perspectives. Muséum national d'Histoire naturelle publ., Paris : 1-246.
- Bellone E., Meinesz A. (1995) - Cartographie sous-marine du Parc national de Port-Cros (Var, France). I – Elément de cartographie de l'herbier de *Posidonia oceanica* de la baie de Port-Man. Sci. Rep. Port-Cros natl. Park, 16: 123-128.
- Belsher T., Houlgatte E. (2000) - Etude des sédiments marins, des herbiers à phanérogames et des peuplements à *Caulerpa taxifolia* de Menton au cap d'Ail (France-Principauté de Monaco). ISBN 2-905434-87-2 ; Editions Ifremer : 1-43 +3 cartes.
- Berné S., Augustin J.M., Braud F., Chene G., Walker P. (1986) - Cartographie et interprétation de la dynamique sédimentaire des plateformes continentales : amélioration de la technique d'observation par sonar latéral. Bull. Soc. géol. France, 2 (3) : 437-446.
- Blanc J.J. (1975) - Recherches de sédimentologie appliquée au littoral rocheux de la Provence, aménagement et protection. Centre national pour l'exploitation des océans publ., Paris : 1-163.
- Boudouresque C.F. (1997) - Population dynamics of *Caulerpa taxifolia* in the Mediterranean, including the mechanisms of interspecific competition. Séminaire international "Dynamique d'espèces marines invasives : application à l'expansion de *Caulerpa taxifolia* en Méditerranée", Lavoisier publ., Paris : 145-162.
- Boudouresque C.F. (2002) - Concilier protection et usages du milieu marin : l'expérience du Parc national de Port-Cros. Rev. Soc. anciens élèves Ecole polytechnique, Jaune Rouge, 575 : 31-35.
- Boudouresque C.F. (2004) - Marine biodiversity in the Mediterranean: status of species, populations and communities. Sci. Rep. Port-Cros natl Park, 20 : 97-146.
- Boudouresque C.F. Arrighi F., Finelli F., Lefèvre J.R. (1995a) - Arrachage des faisceaux de *Posidonia oceanica* par les ancrs : un protocole d'étude. Rapp. Comm. int. Explor. sci. Médit., 34 : 21.
- Boudouresque C.F., Cadiou G., Guerin B., Le Direach L., Robert P. (2004) - Is there a negative interaction between biodiversity conservation and artisanal fishing in a Marine Protected Area, the Port-Cros National Park (France, Mediterranean Sea). Sci. Rep. Port-Cros natl. Park, 20 : 147-160.

Boudouresque C.F., Cadiou G., Le Diréach L. (2005) - Marine protected areas: a tool for coastal areas management. In : Strategic management of marine ecosystems, Levner E., Linkov I., Proth J.M. (éds.), Springer publ., Dordrecht : 29-52

Boudouresque C.F., Charbonnel E., Meinesz A., Pergent G., Pergent-Martini C., Ca-diou G., Bertrand M.C., Foret P., Ragazzi M., Rico-Rai-mondino V. (2000) - A monitoring network based on the seagrass *Posidonia oceanica* in the north-western Mediterranean Sea. Biol. mar. Medit., 7 (2) : 328-331.

Boudouresque C.F., Giraud G., Thommeret J., Thommeret Y.(1980) - First attempt at dating by 14C the undersea beds of dead *Posidonia oceanica* in the bay of Port-Man (Port-Cros, France). Sci. Rep. Port-Cros natl. Park, 6 : 239-242.

Boudouresque C.F., Gravez V., Meinesz A., Molenaar H., Pergent G., Vitiello P. (1994) -L'herbier à *Posidonia oceanica* en Méditerranée : protection légale et gestion. Actes du colloque scientifique OKEANOS, Maison de l'Environnement de Montpellier publ: 209-220.

Boudouresque C.F., Meinesz A., Ribera M.A., Ballesteros E. (1995b) - Spread of the green alga *Caulerpa taxifolia* (*Caulerpales*, *Chlorophyta*) in the Mediterranean: possible consequences of a major ecological event. Scientia marina, 59 (suppl. 1): 21-29.

Boudouresque C.F., Van Klaveren M.C., Van Klaveren P. (1996) - Proposal for a list of threatened or endangered marine and brackish species (plants, invertebrates, fish, turtles and mammals) for inclusion in appendices I, II and III of the Bern Convention. Council of Europe, Document S/TPVS96/TPVS48E, 96A: 1-138.

Bougeant P. (1990) - Un Parc en forme d'île : bilan des vingt cinq premières années de fonctionnement du Parc national de Port-Cros. Atti del 1° Convegno internazionale "Parchi marini del Mediterraneo, Aspetti naturalistici e gestionali", San Teodoro, 28-30 Avril 1989, Ital. : 75-83.

Bourcier M. (1982) - Nouvelles localisations et délimitation fine de quelques faciès de la biocénose des fonds détritiques côtiers dans le Parc national sous-marin de Port-Cros (France, Méditerranée). Trav. sci. Parc nation. Port-Cros, 8 : 19-23.

Cottalorda J.M., Robert P., Charbonnel E., Dimeet J., Menager V., Tillman M., Vau-gelas J. de, Volto E. (1996) - Eradication de la colonie de *Caulerpa taxifolia* découverte en 1994 dans les eaux du Parc national de Port-Cros (Var, France). Second international workshop on *Caulerpa taxifolia*, Ribera M.A., Ballesteros E., Boudouresque C.F., Gómez A., Gravez V. édit., Univ. Barcelona publ.: 149-155.

Francour P., Ganteaume A., Poulain M. (1999) - Effects of boat anchoring in *Posidonia oceanica* seagrass beds in the Port-Cros National Park (North-Western Mediterranean Sea). Aquatic Conserv: Mar. Freshw. Ecosyst., 9 : 391-400.

Francour P., Poulain M., Bernard G., Bonhomme P., Charbonnel E. (1997) - Impact des mouillages forains sur l'herbier à *Posidonia oceanica* dans le Parc National de Port-Cros (Méditerranée nord-occidentale, France). Contrat Parc national de Port-Cros et GIS Posidonie, GIS Posidonie publ., Marseille : 1-51.

Ganteaume A., Bonhomme P., Bernard G., Poulain M., Boudouresque C.F. (2005a) - Impact de l'ancrage des bateaux de plaisance sur la prairie à *Posidonia oceanica* dans le Parc national de Port-Cros (Méditerranée nord-occidentale). Sci. Rep. Port-Cros natl. Park, 21.

Ganteaume A., Bonhomme P., Emery E., Hervé G., Boudouresque C.F. (2005b) - Impact sur l'herbier à *Posidonia oceanica* de l'amarrage des bateaux de croisière, au large du port de Porquerolles (Provence, France, Méditerranée). Sci. Rep. Port-Cros natl. Park., 21.

Giraud G. (1980) - Synthèse cartographique des herbiers de Posidonies (*Posidonia oceanica*) entre Fos-sur-Mer et la rade d'Hyères. DCAN Toulon et Université d'Aix-Marseille II : 1-43.

Harmelin J.G. (1977) - Evolution de l'herbier de posidonies de Port-Cros au niveau de jalons témoins. Trav. sci. Parc natl. Port-Cros, 3 : 210-211.

Harmelin J.G., Laborel J. (1976) - Note préliminaire sur la morphologie de l'herbier profond de posidonies *Posidonia oceanica* (Linné) Delile à Port-Cros. Trav. sci. Parc natl. Port-Cros, 2 : 105-113.

Iehlé A., Wald L., Boudouresque C.F. (1995) - Analyse et évaluation de la fiabilité de l'information dans le système d'information géographique des assemblages benthiques méditerranéens "MBA". Sci. Rep. Port-Cros natl. Park, 16: 99-113.

Jeu de Grissac A., Meinesz A., Boudouresque C.F., Astier J.M., Bourcier M., Lefèvre J.R. (1985) - Localisation de l'herbier de Posidonie sur le littoral P.A.C.A. Etat des connaissances. GIS Posidonie et DRAE Paca publ.: 1-22 + 1-37 + 1-19.

Jousson O., Pawlowski J., Zaninetti L., Meinesz A., Boudouresque C.F. (1998) - Molecular evidence for the aquarium origin of the green alga *Caulerpa taxifolia* introduced to the Mediterranean Sea. Mar. Ecol. Progr. Ser., 172: 275-280.

Jousson O., Pawlowski J., Zaninetti L., Zechman E.W., Dini F., Giaccone G., Wood-field R., Millar A., Meinesz A. (2000) - Invasive alga reaches California. Nature, 408 : 157-158.

Loquès F., Bellone E., Meinesz A., Villette M. (1995) - Cartographie sous-marine du Parc national de Port-Cros (Var, France). II – La zone protégée de la baie de La Palud. Sci. Rep. Port-Cros natl. Park, 16: 129-133 + 1 carte h.t.

Mayot N., Boudouresque C.F., Leriche (2005) - Unexpected response of the seagrass *Posidonia oceanica* to a warm water episode in the North Western Mediterranean Sea. C.R. Biologies, 328: 291-296.

Meinesz A., Belsher T., Boudouresque C.F., Lefèvre J.R. (1991) - Première évaluation des potentialités du satellite SPOT pour la cartographie des peuplements benthiques superficiels de Méditerranée occidentale. Oceanologica Acta, 14: 199-207.

Meinesz A., Belsher T., Thibaut T., Antolic B., Ben Mustapha K., Boudouresque C.F., Chiaverini D., Cinelli F., Cottalorda J.M. *et al.* (2001) - The introduced alga *Caulerpa taxifolia* continues to spread in the Mediterranean. Biological Invasions, 3 : 201-210.

Meinesz A., Cuvelier M., Laurent R. (1981) - Méthodes récentes de cartographie et de surveillance des herbiers de phanérogames marines. Leurs applications sur les côtes françaises de la Méditerranée. Vie Milieu, 31 : 27-34.

Molinier R., Picard J. (1952) - Recherches sur les herbiers de phanérogames marines du littoral méditerranéen français. Ann. Inst. océanogr., 27 (3) : 157-234.

Pasqualini V. (1997) - Caractérisation des peuplements et types de fonds le long du littoral corse (Méditerranée, France). Thèse Doct. Univ. Corse, Fr: 1-190.

Pasqualini V., Clabaut P., Pergent G., Benyousse L., Pergent-Martini C. (2000) - Contribution of side scan sonar to the management of Mediterranean littoral ecosystems. Intern. J. Remote Sensing, 21 (2) : 367-378.

Pasqualini V., Pergent-Martini C., Clabaut P., Pergent G. (1998) - Mapping of *Posidonia oceanica* using aerial photographs and side scan sonar: application off the Island of Corsica (France). Estuarine, Coastal Shelf Sci., 47: 359-367.

Pères J.M., Picard J., (1963) - Aperçu sommaire sur les peuplements marins benthiques entourant l'île de Port-Cros. Terre Vie, Rev. Ecol., 110 (4): 436-448.

Pères J.M., Picard J. (1964) - Nouveau manuel de bionomie benthique de la Mer Méditerranée. Rec. Trav. Stat. mar. Endoume, 31 (47) : 3-137.

Pergent G. (1991) - La protection légale de la Posidonie en France : un outil efficace – nécessité de son extension à d'autres pays méditerranéens. Les espèces marines à protéger en Méditerranée, Boudouresque C.F., Avon M., Gravez V. édés., GIS Posidonie publ. Marseille : 29-33.

Politano E. (1992) - Analisi critica delle metodologie per la zonizzazione dell'ambiente marino e terrestre nei parchi nazionali. Caso studio : penisola del Sinis e isola del Mal di Ventre. Parte 1a. Analisi critica di alcuni metodi per la valutazione della qualità ambientale di zone destinate a Parco Nazionale. Parchi marini del Mediterraneo, problemi e prospettive. Atti del 2° convegno internazionale, San Teodoro, Sardegna, Ital.: 142-147.

Ramos-Espla A.A., McNeill S.E. (1994) - The status of marine conservation in Spain. Ocean Coastal Management, 24 : 125-138.

Robert P. (1996) - Recherche de l'algue *Caulerpa taxifolia* dans les eaux du Parc National de Port-Cros. Second international workshop on *Caulerpa taxifolia*, Ribera M.A., Ballesteros E., Boudouresque C.F., Gómez A., Gravez V. édit., Univ. Barcelona publ. : 99-100.

Robert P. (2001) - Mission d'éradication localisée de l'algue *Caulerpa racemosa* dans les eaux du Parc national de Port-Cros. Août-Septembre 2001. Parc national de Port-Cros publ., Hyères, Fr. : 17 p. non num.

Robert P. (2002) - Mission de recherche de l'algue *Caulerpa taxifolia* dans les eaux du Parc National de Port-Cros. Parc national de Port-Cros publ., Hyères, Fr. : 1-8 + 1 pl. h.t.

Robert P., Gravez V. (1998) - Contrôle de l'algue *Caulerpa taxifolia* dans le Parc national de Port-Cros (Var, France). Third international workshop on *Caulerpa taxifolia*, Boudouresque C.F., Gravez V., Meinesz A., Palluy F. édés., GIS Posidonie publ., : 79-87.

Romero J. (1997) - Conséquences de l'expansion de *Caulerpa taxifolia* en Méditerranée. Dynamique d'espèces marines invasives : application à l'expansion de *Caulerpa taxifolia* en Méditerranée, Lavoisier publ., Paris : 241-254.

Roy D., Divetain N., Bernard G., Coquillard Y., Bonhomme P., Gravez V. (1999) - Prospection de trois systèmes de mouillage en rade d'Hyères – Analyse et recommandations pour une éventuelle installation en baie de Port-Cros. Contrat Parc National de Port-Cros & GIS Posidonie, Parc National de Port-Cros & GIS Posidonie publ., Marseille : 1-32.

Verlaque M., Boudouresque C.F., Meinesz A., Gravez M. (2000) - The *Caulerpa racemosa* complex (*Caulerpales*, *Ulvophyceae*) in the Mediterranean Sea. Botanica Marina, 43 : 49-68.

Weber O. (1989) - Utilisation et intérêt de l'emploi du sonar latéral sur le plateau continental. Cours intensif eu-ropéen ; connaissance et gestion de la frange littorale et du proche plateau continental. AESTM édit., Strasbourg : 333-356.

LA CARTOGRAPHIE DES HERBIERS À *POSIDONIA OCEANICA* EN ITALIE

Francesco CINELLI, Stefano ACUNTO, David BALATA. et Luigi PIAZZI

Dipartimento di Scienze dell'Uomo e dell'Ambiente – Università di Pisa Via A. Volta 6, 56126 Pisa Italie

ABSTRACT

Le long des côtes italiennes, les fonds littoraux entre 0 et 50 mètres et donc les herbiers à *Posidonia oceanica* (Posidoniaceae) ont été cartographiés presque entièrement, à l'exception de la Mer Adriatique centrale et septentrionale. Les derniers projets de cartographie ont été réalisés à partir du matériel obtenu au moyen du sonar à balayage latéral et de la télédétection aérienne. Des transects perpendiculaires à la côte ont été parcourus par des caméras sous-marines pour l'interprétation des données. Enfin des plongeurs autonomes ont été employés pour obtenir des mesures de densité des faisceaux et des échantillons pour l'étude de la production primaire, de la phénologie, des peuplements épiphytes et des sédiments. Un système SIG a été construit sur la base des informations de la distribution, des données écologiques et biologiques des herbiers.

KEY WORDS: *Posidonia oceanica*, mapping, Italy

INTRODUCTION

La cartographie des fonds marins littoraux est considérée comme une priorité, car c'est grâce à ces documents que l'on peut obtenir la connaissance de la distribution des biocénoses et permettre la gestion de la zone côtière. Les documents cartographiques permettent également de suivre l'évolution dans les temps des biocénoses, en discernant les tendances de progression ou de régression. Enfin, l'analyse des peuplements cartographiés permet d'évaluer la production primaire des aires côtières. En Méditerranée, la cartographie des fonds marins littoraux a été essentiellement associée à la connaissance de la distribution et à la surveillance des herbiers de la phanérogame marine *Posidonia oceanica* (L.) Delile, compte tenu de l'importance écologique et la fragilité de cette biocénose. Le long des côtes italiennes, les fonds littoraux entre 0 et 50 mètres, et donc les herbiers à *Posidonia oceanica*, ont été presque totalement cartographiés, à l'exception de la Mer Adriatique centrale et septentrionale. La cartographie a été réalisée pendant plusieurs années en utilisant plusieurs méthodes. (Fig.1)

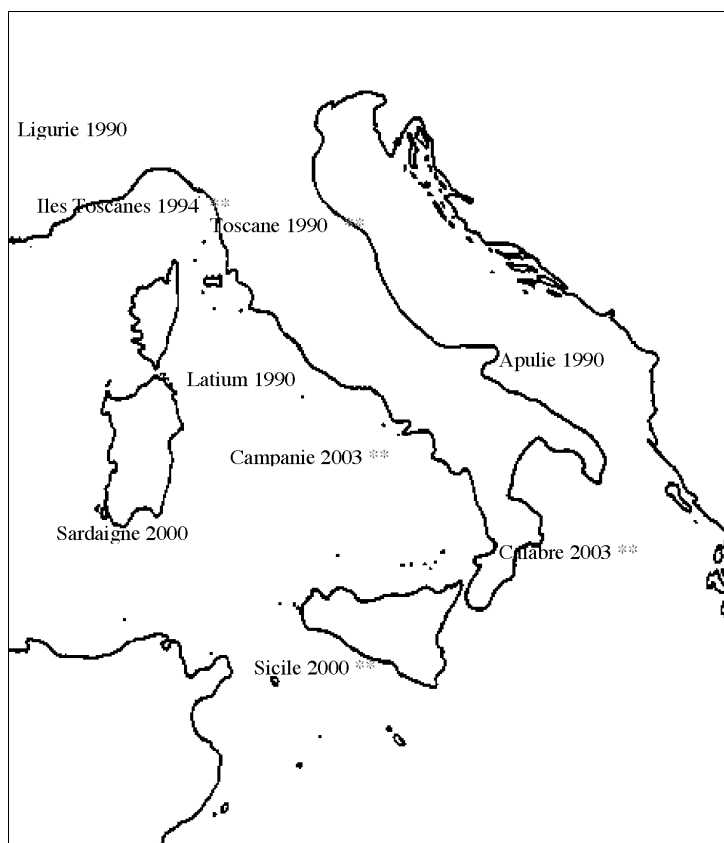

Fig. 1 La cartographie des herbiers à *Posidonia oceanica* en Italie: les années de réalisation
 ** Réalisées par l'Université de Pisa

METHODES DIRECTES

Les méthodes directes ont été utilisées pour la cartographie de petites surfaces. La technique des transects parcourus par des plongeurs a permis d'obtenir des cartographies très précises de certaines zones sensibles et de surveiller la dynamique des herbiers le long des côtes toscanes (Piazzini *et al.*, 1996).

Calvo *et al.* (1993) ont utilisé un instrument topographique (géodimètre) pour tracer la limite de l'herbier de la Baie de Mondello, en Sicile.

Des caméras ont été employées pour des observations le long des côtes du Latium (Ardizzone et Pelusi, 1984; Ardizzone, 1992).

LE SONAR A BALAYAGE LATERAL

Le sonar à balayage latéral représente maintenant la méthode la plus utilisée pour la cartographie des fonds marins. En Italie, le sonar à balayage latéral a été utilisé pour l'étude de la Posidonie à partir des années 80, notamment lors de la cartographie des herbiers autour de l'île d'Ischia, dans le Golfe de Naples (Colantoni *et al.*, 1982). Quelques années plus tard, la cartographie des côtes de la Ligurie, Toscane, Latium et Apulie a été effectuée essentiellement à l'aide du sonar à balayage latéral (Snamprogetti, 1989; AAVV, 1991; Cinelli et Piazzì, 1991; Diviaco, 1991; Diviaco *et al.*, 2001; Bianchi et Peirano, 1995).

PHOTOGRAPHIE AERIENNE ET TELEDETECTION SATELLITAIRE

La photographie aérienne et la télédétection satellitaire sont des méthodes régulièrement employées pour la cartographie des phanérogames marines, mais en Méditerranée leur utilisation ne permet d'identifier que la limite supérieure des herbiers à *Posidonia oceanica*, du fait de la distribution bathymétrique de cette phanérogame. Des images aérophotogrammétriques ont été utilisées pour la cartographie du récif barrière de Santa Liberata (Toscane) (Lenzi, 1987) et de la limite supérieure des herbiers à l'île de l'Asinara (Sardaigne) (Cossu *et al.*, 2002). L'analyse d'images satellitaires a permis la cartographie de la Baie de Mondello (Calvo *et al.*, 1993).

INTEGRATION DE PLUSIEURS METHODES

Les derniers projets de cartographie intègrent l'utilisation des plusieurs méthodes en même temps. Cette intégration a été réalisée pour la première fois en 1994 pour l'île d'Elbe (Acunto *et al.*, 2000; Piazzì *et al.*, 2000). Par la suite, les herbiers présents le long des côtes de la Sardaigne (AAVV, 2002), de la Sicile et ses îles (AAVV, 2002) ont été cartographiés. La cartographie de Campanie et Calabre a été terminée au cours de cette année. Ces derniers projets ont été réalisés à partir des données obtenues au moyen du sonar à balayage latéral et de la télédétection aérienne. Des radiomètres avec des images multispectrales pour le visible et l'infrarouge ont été utilisés. Des transects perpendiculaires à la côte ont été parcouru par des cameras sous-marines pour l'interprétation des données. Enfin des plongeurs en scaphandre autonomes ont été employés pour obtenir des mesures de densité des faisceaux et des échantillons pour l'étude de la production primaire, de la phénologie, des peuplements épiphytes et des sédiments. Ces informations sont intégrées dans la cartographie de la posidonie, permettant de mieux appréhender la situation écologique des herbiers. Pendant la

cartographie de la Sicile les résultats de l'analyse des échantillons ont permis d'obtenir des informations sur les secteurs dégradés autour de l'île et sur les herbiers qui doivent être protégés. L'intégration de la cartographie avec des informations sur l'écologie des herbiers représente une importante aide pour la gestion du milieu marin littoral. Un système SIG (Système d'Informations Géographiques) a été construit sur la base des informations de distribution, des données écologiques et biologiques des herbiers. L'intérêt de ce système est lié à sa capacité d'intégrer des grandes quantités de données spatiales et d'être capable d'analyser les relations parmi ces données.

REFERENCES

- Acunto S., Piazzi L., Cinelli F. (2000) - Mappatura delle praterie a *Posidonia oceanica* dell'Isola d'Elba. *Biol. Mar. Medit.*, 7: 495-498.
- Ardizzone G.D. (1992) - Cartografia bentica con sistemi video controllati a distanza. *Oebalia*, 27: 441-452.
- Ardizzone G.D., Pelusi P. (1984) - Yield and damaging evaluation of bottom trawling on *Posidonia* meadows. *In: Boudouresque C.F., Jeudy de Grissac A., Olivier J. (eds). First International Workshop on Posidonia oceanica beds. GIS posidonie publ., Marseille, 1: 63-72.*
- Ardizzone G.D., Belluscio A. (1996) - Le praterie di *Posidonia oceanica* lungo le coste laziali. *In: Il mare del Lazio. Università di Roma "la Sapienza". Regione Lazio: 194-217.*
- Bedini R., Canali M.G., Bulleri F., Bedini A., Fantini R., Magnarini L., Franca A., Colantoni P. (2002) - Mappatura del limite superiore di alcune praterie di *Posidonia oceanica* lungo la costa toscana. *Biol. Mar. Medit.*, 7: 499-508.
- Bianchi C.N., Peirano A. (1995) - Atlante delle fanerogame marine della Liguria: *Posidonia oceanica* e *Cymodocea nodosa*, ENEA Centro ricerche ambiente marino, La Spezia: 146 pp.
- Bozzano R., Castellano L. (2000) - Utilizzo di un sonar ad alta frequenza per la mappatura di praterie di *Posidonia oceanica*. *Biol. Mar. Medit.*, 7: 580-582.
- Calvo S., Fradà-Orestano C., Abbadessa P. (1993) - The suitability of a topographical instrument for an integrated approach to the cartography of *Posidonia oceanica* meadows, *Oceanol. Acta*, 16: 273-278.
- Calvo S., Ciruolo G., Di Stefano C., La Loggia G. (1995) - Cartografia della vegetazione sommersa lungo la fascia costiera in Mediterraneo attraverso l'impiego di tecniche di telerilevamento. *In: Cinelli F., Fresi E., Lorenzi C., Mucedola A. (eds). La Posidonia oceanica. Rivista Marittima: 142-149.*
- Cinelli F., Piazzi L. (1990) - Mappatura delle praterie a *Posidonia oceanica* (L.) Delile lungo le coste Toscane. CIBM Livorno Relazione Tecnica interna: 80 pp.
- Cinelli F., Pardi G., Papi I., Benedetti-Cecchi L. (1995) - Mappatura delle praterie a *Posidonia oceanica* (L.) Delile intorno alle isole minori dell'Arcipelago Toscano. *Atti Soc. Tosc. Sc. Nat.*, 102 : 93-110.
- Colantoni P., Galignani P., Fresi E., Cinelli F. (1982) - Patterns of *Posidonia oceanica* (L.) Delile beds around the Island of Ischia (Gulf of Naples) and in adjacent waters. *P.S.Z.N.I. Mar. Ecol.*, 3: 53-74.
- Cossu A., Gazale V., Orru P., Pala D., Puddu A. (2002) - Lineamenti morfologici e cartografia dei popolamenti bentonici di Rada Reale dell'Isola dell'Asinara (Sardegna NW). *Biol. Mar. Medit.*, 7: 478-487.

Diviaco G. (1991) - Progetto di Mappatura delle praterie di *P. oceanica* – Regione Lazio. Relazione ICRAP Snam Progetti – Ministero Marina Mercantile: 183 pp.

Diviaco G., Spada E., Virno Lamberti C. (2001) - Le fanerogame marine del Lazio. ICRAM: 113 pp.

Lenzi M. (1987) - Le récif-barrière de *Posidonia oceanica* (L.) Delile de Santa Liberata (Toscane, Italie): cartographie et biometrie. Giorn. Bot. Ital., 121: 155-164.

Piazzì L., Balestri E., Cinelli F. (1996) - Mappatura e monitoraggio di una prateria a *Posidonia oceanica* (L.) Delile situata a sud di Livorno (Toscana, Italia). Inf. Bot. Ital., 28: 67-77.

Piazzì L., Acunto S., Papi I., Pardi G., Cinelli F. (2000) - Mappatura delle praterie a fanerogame marine della Toscana. Biol. Mar. Medit., 7: 594-596.

Snamprogetti Spa. (1989) - Mappatura delle praterie a *Posidonia oceanica*. Stato dell'arte. Relazione. Ministero della Marina Mercantile, Ispettorato Centrale per la Difesa del Mare: 199 pp.

AAVV (1991) - Mappatura delle praterie a *Posidonia oceanica* (L.) Delile lungo le coste di Liguria, Toscana, Lazio, Basilicata e Puglia. Ministero della Marina Mercantile - Ispettorato Centrale per la Difesa del Mare.

AAVV (2002) - Mappatura delle praterie di *Posidonia oceanica* lungo le coste della Sicilia e delle Isole minori circostanti. Ministero dell'Ambiente – Servizio Difesa del Mare.

AAVV (2002) - Mappatura delle praterie di *Posidonia oceanica* lungo le coste della Sardegna e delle Isole minori circostanti. Ministero dell'Ambiente – Servizio Difesa del Mare.

CARTOGRAPHIE DU RECIF-BARRIERE DE POSIDONIES DE LA BAIE DE SIDI RAÏS (CÔTES NORD-ORIENTALES DE LA TUNISIE)

Souha .EL ASMI¹, Chedly RAIS¹, Mohamed Salah ROMDHANE² et Soumaya EL HERRY²

¹Centre d'Activités Régionales pour les Aires Spécialement Protégées (CAR/ASP) BP 337 - 1080 Tunis CEDEX - Tunisie

²Institut National Agronomique de Tunisie (INAT)

RESUME

La baie de Sidi Rais (côtes nord-orientales de la Tunisie) abrite un vaste herbier à *Posidonia oceanica* (L.) Delile renfermant un récif-barrière, l'un des mieux conservés du golfe de Tunis. Au courant de l'été 2001, une campagne de cartographie, s'est déployée sur une surface de près de 130 ha. La technique de cartographie s'est basée sur l'observation du fond suivant 35 radiales parallèles distantes de 50 m, qui débutent au niveau du rivage et s'étendent sur 750 m vers le large. Les observations se sont effectuées le long de ces radiales à 25 mètres d'intervalle, ce qui nous ramène à un réseau de 1050 stations d'échantillonnage visuel. Les résultats montrent un herbier continu, étendu sur la quasi-totalité de la surface cartographiée et caractérisé par un recouvrement, la plupart du temps, supérieur à 75 %. Le récif-barrière, quant à lui, n'est pas continu ; Il se présente sous forme d'îlots d'herbier frangeant séparés par un herbier eynodocea plus profond, par des prairies à *Cymodocea nodosa* (Ucria) Ascherson ou des prairies mixtes à *Cymodocea nodosa* et à *Caulerpa prolifera* (Forsskal) Lamouroux.

MOTS-CLES : *Posidonia oceanica*, récif-barrière, cartographie, baie de Sidi Rais

INTRODUCTION

L'herbier à *Posidonia oceanica* constitue, avec le coralligène, l'écosystème marin le plus important de la Méditerranée (Boudouresque et Meinesz, 1982 ; Boudouresque, 1997). Vu leur rareté et leur fragilité, les récifs-barrières sont des formations végétales considérées comme de véritables "monuments naturels" endémiques de la Méditerranée (PNUE, 1999).

L'herbier à *Posidonia oceanica* est présent le long de l'ensemble des côtes tunisiennes. Le Danois (1925) indique que son extension est très limitée au niveau du golfe de Tunis. Ce n'est qu'au sud du golfe que des herbiers superficiels ont été signalés à Sidi Raïs par Molinier et Picard (1954) et par Ben Alaya (1972). Ce dernier a signalé un récif-barrière à *Posidonia oceanica* à 1,5 km au large de Sidi Raïs.

Malgré sa relative importance, l'herbier à *Posidonia oceanica* de Sidi Raïs et son récif-barrière ont suscité, jusqu'à aujourd'hui, très peu d'intérêt chez les scientifiques. C'est bien dans une optique de description et de caractérisation de l'état de cet herbier et de cartographie de son récif-barrière que nous nous sommes intéressés dans le cadre de cette étude.

Le site de Sidi Raïs est localisé à 45 Km de Tunis entre Soliman et Korbous. La baie de Sidi Raïs est située au Sud-est du golfe de Tunis (Fig. 1).

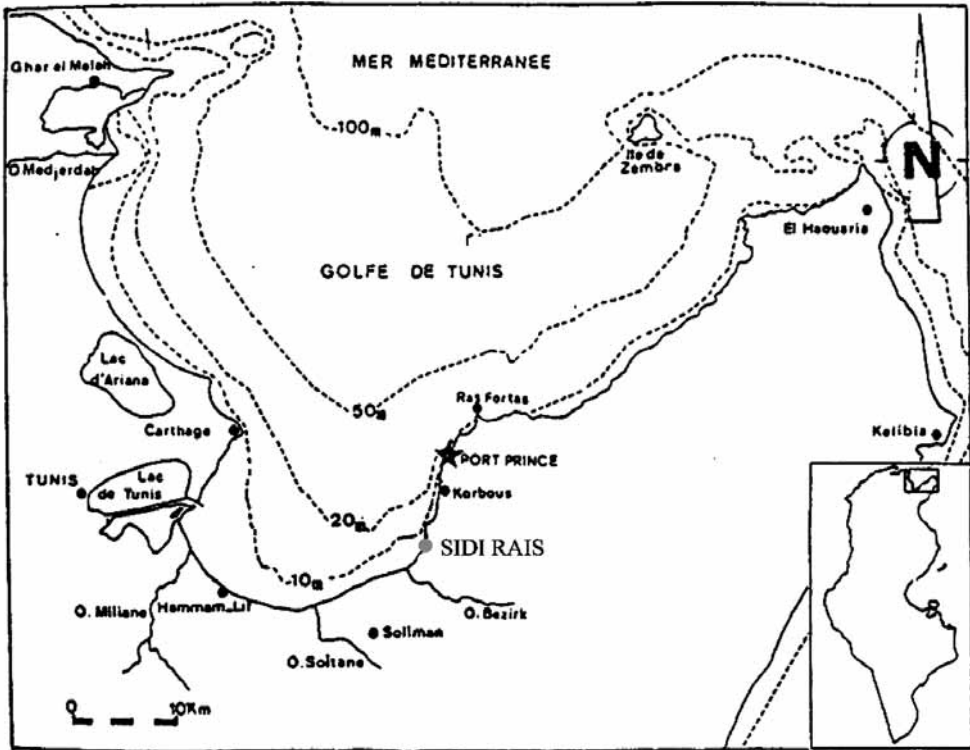

Fig. 1 : Situation géographique de la région de Sidi Raïs

MATERIEL ET METHODES

La littérature ainsi que de multiples investigations préliminaires réalisées sur le terrain laissent croire que l'herbier à *Posidonia oceanica* de Sidi Rais est très vaste. Il semble, en effet, s'étendre vers le Nord jusqu'à la pointe de Ain Oktor (probablement davantage) en extension littorale et atteindre également d'assez grandes profondeurs, jusqu'à l'isobathe 15 m selon Ben Alaya (1972). Quant au récif-barrière, il s'étendrait parallèlement à la côte sur une longueur de près de 2 km. Notre zone d'étude a été choisie de façon à circonscrire au mieux ce récif-barrière. La surface cartographiée était un tétraèdre de 1700 m de long sur 750 m de large. Mille sept cents mètres étant la distance parcourue parallèlement au linéaire côtier et 750 mètres étant la distance parcourue vers le large perpendiculairement à la côte. La surface couverte s'élève donc à près de 130 ha. Le périmètre cartographié s'étend entre les latitudes 36°45'58"N et 36°46'59"N et les longitudes 10°32'22"E et 10°33'07"E (Fig. 2).

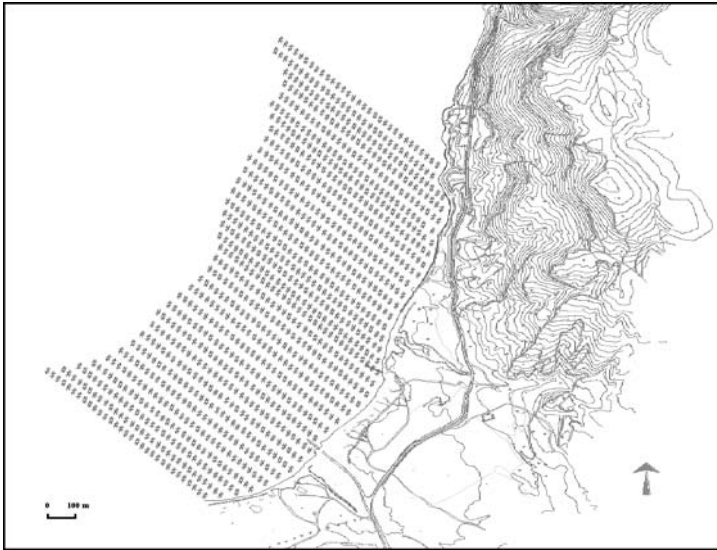

Fig. 2 : Périmètre d'étude choisie dans la région de Sidi Rais

La méthode de cartographie mise en place a été inspirée par celle utilisée par Ramos-Esplà (1984) pour la cartographie de l'herbier superficiel de la baie d'Alicante, qui dans le but de délimiter l'herbier à *Posidonia oceanica* et d'évaluer son état, avait réalisé une série de prospections en scaphandre autonome sur 14 transects de 2 km de longueur. La cartographie de l'herbier a été alors réalisée en distinguant quatre états distincts de l'herbier : (i) herbier dense, (ii) herbier en voie de dégradation présentant des structures érosives (chenaux), (iii) herbier très dégradé et (iv) matre morte avec uniquement un enchevêtrement de rhizomes et de racines (Ramos-Esplà, 1984).

Notre campagne de prospection s'est déroulée en une vingtaine de sorties en mer pendant les mois de juillet, août et septembre 2001. Comme notre méthode de cartographie et de caractérisation de l'herbier superficiel de Sidi Rais se base presque exclusivement sur l'observation, les premières prospections de terrain nous ont permis de nous familiariser avec les différents états et aspects que peut présenter l'herbier et d'identifier les différentes catégories selon lesquelles nous allons le classifier. Cette classification se basera essentiellement sur l'observation des paramètres suivants : recouvrement, vitalité et état de l'herbier, longueur des feuilles, degré d'épiphytisme et présence ou absence de mat. La technique de cartographie mise en place offre l'avantage d'être à la fois facile, assez précise et très peu coûteuse.

Les observations de l'herbier et des différentes biocénoses benthiques se sont effectuées suivant 35 radiales parallèles qui débutent au niveau du rivage et s'étendent sur une distance de 750 m vers le large. Le long de ces radiales, les observations se sont effectuées à 25 mètres d'intervalles, ce qui nous amène à un réseau de 1050 stations d'observation sur toute la surface prospectée (Figure 2). La technique en elle-même consiste à se déplacer à bord d'une embarcation le long de la radiale en observant le fond à l'aide d'une lunette de Calfat et en notant les observations à intervalle régulier de 25 mètres. Pour matérialiser nos radiales et pour pouvoir nous déplacer rectilignement de la côte vers le large, un filin normé tous les 25 m et attaché à un piquet bien fixé sur la plage est déployé au fur et à mesure que la barque s'avance vers le large. Notre filin est garni par endroit de grandes bouées qui nous permettent de visualiser sa trajectoire de loin et de contrôler sa rectilignité par rapport à la direction choisie à mesure que nous progressons vers le large. Le positionnement sur le terrain ainsi que la direction de progression de la barque sont maintenus grâce au système de positionnement par satellite par le biais d'un appareil GPS (Global positioning system). Une fois nous avons parcouru les 750 m de radiale, nous prenons le chemin du retour vers la côte, en prenant soin de ranger notre filin soigneusement dans un panier de façon qu'il ne s'emmêle pas. Une fois le travail terminé le long d'une radiale donnée, nous déplaçons notre dispositif (piquet, filin et bouées) 50 m plus loin, perpendiculairement à la direction de la première radiale et nous redéployons le filin parallèlement à sa position précédente en évoluant vers le large et en observant le fond. Munis d'un échosondeur portatif, cette méthode nous a aussi permis d'effectuer un lever bathymétrique détaillé de la zone cartographiée.

Le logiciel ArcView GIS version 3.0 a été utilisé pour créer notre base de données SIG. Nos observations in situ peuvent être assimilées à des points. Chacune de nos 35 radiales prospectées sur terrain comporterait donc une série de 30 points. Ce qui nous

amène à porter sur la carte du site (au 1/5000^{ème}) un ensemble de 1050 points couvrant toute la surface prospectée et correspondant à l'ensemble de nos observations sur terrain. Chaque point porté sur la carte est défini par ses coordonnées géographiques ou par la distance qui le sépare d'un autre point bien localisé sur la carte (de coordonnées géographiques connues). Afin de compléter notre travail sur le SIG et d'implanter notre base de données, nous avons eu à créer une table et à y introduire les attributs de chaque point porté sur la carte. Ces attributs correspondent aux identifiants caractérisant ou quantifiant les différents paramètres observés sur le terrain : le type de fond, le recouvrement de l'herbier à *Posidonia oceanica*, la longueur des feuilles, le degré d'épiphytisme des feuilles, l'état de l'herbier à *Posidonia oceanica*, la présence ou l'absence de matte sous-jacente à l'herbier de posidonies, les algues accompagnatrices et la profondeur. Ces identifiants peuvent être de type caractère ou de type numérique. L'ensemble de ces points et les identifiants qui leur sont attribués constituent le noyau de la base de données SIG qui sera utilisée pour générer des cartes multicouches.

RESULTATS

Sur la base du fond de carte au 1/5000^{ème} intégré à la base de données, il nous a été donc possible d'obtenir un certain nombre de cartes thématiques. Les cartes ainsi générées sont les suivantes :

- Carte biocénotique de la zone prospectée
- Localisation de l'herbier à *Posidonia oceanica*
- Localisation de la prairie de *Cymodocea nodosa*
- Localisation du récif-barrière (Fig. 3)
- Carte bathymétrique (Fig. 4)
- Localisation de quelques espèces algales relativement abondantes
- Caractérisation du recouvrement de l'herbier (Fig. 5)
- Caractérisation du degré d'épiphytisme des feuilles (Fig. 6)
- Caractérisation de la longueur des feuilles
- Présence ou absence de matte sous-jacente
- Caractérisation de l'état de l'herbier

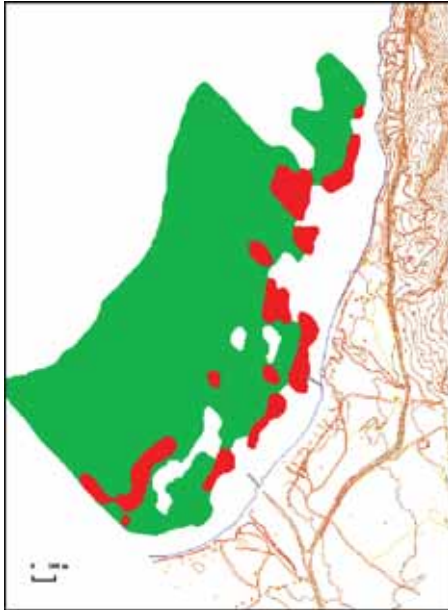

- *Herbier de posidonies*
- *Récif-barrière de posidonies*
- *Absence d'herbier de posidonies*

Fig. 3. Localisation du récif-barrière de la région de Sidi Rais

La carte de localisation de l'herbier de posidonies de la zone cartographiée au large de la région de Sidi Rais (Fig. 3) montre un herbier continu et étendu sur la quasi-totalité de la surface cartographiée. Néanmoins, ce n'est pas le cas au niveau de la côte rocheuse se trouvant dans la partie la plus au nord de la zone d'étude. Dans ce secteur, l'herbier n'est pas très étendu. Il s'étend sur 250 mètres en moyenne, au-delà du récif-barrière. Vers les plus grandes profondeurs, l'herbier cède la place à une étendue de sable. La prairie de *Cymodocea nodosa* s'étend tout au long de la côte avec une limite fortement sinueuse. Celle-ci s'élargit légèrement dans la moitié Nord de la zone cartographiée, pour se rétrécir ensuite au niveau de la limite extrême-nord, c'est-à-dire au niveau de la falaise rocheuse. Il se trouve aussi que l'herbier à *Posidonia oceanica* est parsemé de clairières de sables et de chenaux intermattes. Ce sont les chenaux intermattes qui en s'élargissant, peuvent confluer entre eux pour donner de grandes clairières de sable et/ou de matte morte recouverte de sable, selon que l'herbier est superficiel ou profond. Le "récif-barrière" à *Posidonia oceanica* de Sidi Rais n'est pas un récif continu et parallèle au rivage, comme son nom laisserait entendre (Fig. 3). Il se présente sous forme d'îlots d'herbier frangeant séparés par un herbier plus profond ou par des prairies à *Cymodocea nodosa* ou des prairies mixtes à *Cymodocea nodosa* et à *Caulerpa prolifera*.

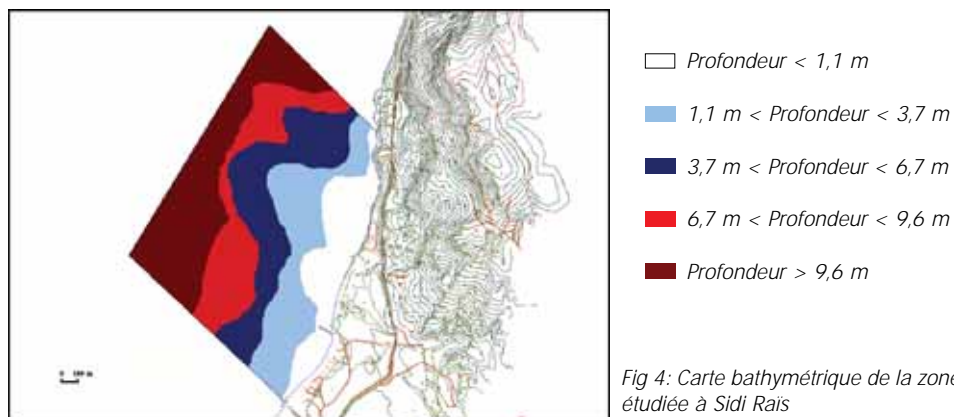

Fig 4: Carte bathymétrique de la zone étudiée à Sidi Rais

La superposition de la cartographie de l'herbier (Fig 3) et de la carte bathymétrique de la région (Fig 4) témoigne que l'installation du récif-barrière dépend étroitement de la profondeur du milieu de cette interdépendance. Il est vrai que la montée d'un herbier vers la surface et la naissance d'un herbier frangeant est condition d'un hydrodynamisme particulièrement atténué. Ces conditions particulières ne sont accomplies qu'au niveau des baies abritées (comme c'est le cas dans la petite baie de Sidi Rais) et par de faibles profondeurs, à l'approche du rivage.

Quant à la caractérisation de l'état de l'herbier suivant plusieurs paramètres sondés visuellement, celle-ci se présentent comme suit :

a) Recouvrement : L'herbier à *Posidonia oceanica* prospecté au large de Sidi Rais est un herbier continu et a généralement un bon recouvrement qui, estimé visuellement, paraît plus important dans le secteur Sud de la zone d'étude (Fig. 5).

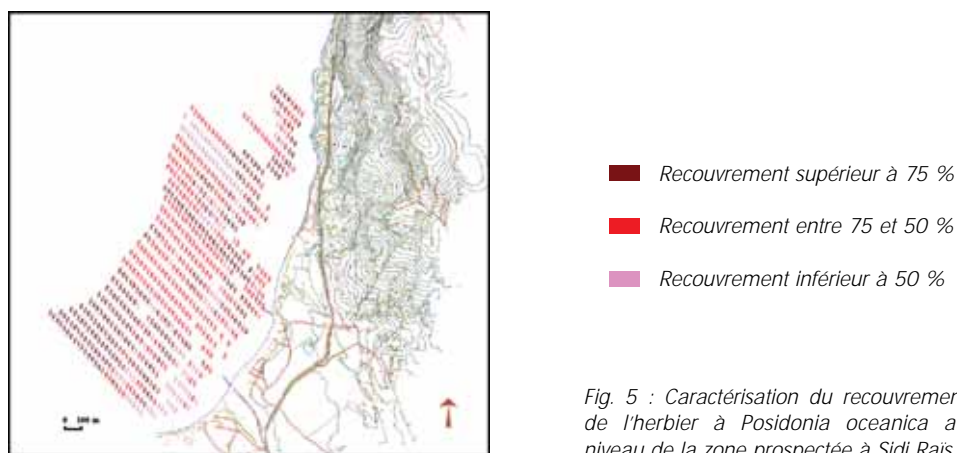

Fig. 5 : Caractérisation du recouvrement de l'herbier à *Posidonia oceanica* au niveau de la zone prospectée à Sidi Rais

b) Degré d'épiphytisme: La turbidité moyenne des eaux, estimée visuellement est plus importante au niveau du secteur Sud qu'au niveau du secteur Nord. Cela se traduit par un épiphytisme plus marqué dans le premier secteur (Sud) que dans le second (Fig. 6). Toutefois, compte tenu de la période de travail (juillet à septembre), cet épiphytisme est peu important par rapport à ce qui est normalement observé, à des profondeurs équivalentes, sur le reste du littoral. Il est à noter que les feuilles de l'herbier frangeant sont particulièrement très épiphytées du fait qu'elles se trouvent près de la surface de l'eau.

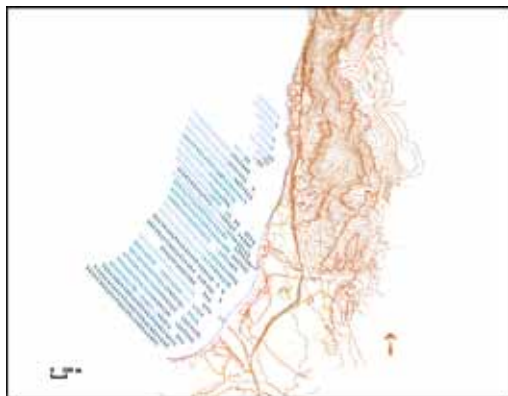

Fig. 6 : Caractérisation du degré d'épiphytisme de l'herbier de *Posidonia* au niveau de la zone prospectée à Sidi Raïs

c) Longueur des feuilles : l'estimation visuelle de la longueur relative des feuilles nous laisse conclure que *Posidonia oceanica* est dotée de longues feuilles sur pratiquement toute la surface prospectée de l'herbier. Cependant, nous remarquons qu'il n'existe qu'un seul secteur caractérisé par des feuilles courtes. Ce secteur se situe au niveau du prolongement de l'apportement. Les feuilles de *Posidonia* sont aussi estimées comme étant moins longues au niveau du récif-barrière. Ces feuilles qui affleurent à la surface sont généralement de petite taille et leurs apex sont souvent détruits.

d) Présence de mat: La présence de matte superficielle est une caractéristique du récif-barrière. C'est pour cela que l'existence de matte sous-jacente à l'herbier a été toujours détectée au niveau de l'herbier frangeant et au niveau de ses alentours immédiats. Cependant, au niveau de quelques secteurs, la matte peut persister au-delà du récif-barrière vers de plus grandes profondeurs. Ceci est le cas de deux secteurs au Nord et au Sud du périmètre prospecté.

e) Etat de l'herbier: L'estimation de l'état de l'herbier compte tenu de toutes ses caractéristiques visibles : longueur, couleur et vigueur des feuilles, degré d'épiphytisme, nous révèle que l'herbier de *Posidonia* de Sidi Raïs se porte bien à part les zones d'herbier frangeant où les feuilles sont nécrosées de couleur noire, très épiphytées et assez courtes. L'évaluation de l'état général de l'herbier prospecté au large de Sidi Raïs est plutôt satisfaisante. Le secteur se portant le moins bien est celui se trouvant le plus

au Sud, surtout la zone située dans le prolongement immédiat de l'apportement. Elle est dotée d'un fort degré d'épiphytisme et de feuilles relativement courtes, selon les observations citées plus haut.

CONCLUSIONS

L'hypothèse selon laquelle nous sommes en présence d'un écosystème à *Posidonia oceanica* très proche d'un peuplement naturel initial, ne peut être écartée. Seule une étude plus détaillée, pluridisciplinaire, prenant en compte une approche fonctionnelle de l'écosystème à *Posidonia oceanica* du site de Sidi Raïs, sur de longues périodes de temps sera en mesure de confirmer ou d'infirmer cette hypothèse.

Cette étude de l'herbier de Sidi Raïs nous a révélé l'existence d'un récif-barrière de grande taille (plus de 100 ha), qui dans l'ensemble est bien conservé.

Par ailleurs, la baie de Sidi Raïs présente un intérêt du point de vue de la conservation, en particulier grâce à la présence d'espèces en danger à l'échelle de la Méditerranée (*Pinna nobilis*, *Cystoseires*, etc.).

REFERENCES BIBLIOGRAPHIQUES

- Ben Alaya H. (1972) - Répartition et conditions d'installation de *Posidonia oceanica* Delile et *Cymodocea nodosa* Ascherson dans le golfe de Tunis. Bull. Inst. océanogr. Pêche Salammbô, Tun., 2 (3): 331-416.
- Boudouresque C.F. (1997) - La diversité biologique marine et lagunaire en Tunisie. Etat et connaissances actuelles, Recommandations pour une stratégie nationale de conservation et d'utilisation durable. Partie 2: Situation de la biodiversité marine et lagunaire en Tunisie. MEAT / PNUE-PAM-CAR/ASP publ.: 1-154.
- Boudouresque C.F., Meinesz A. (1982) - Découverte de l'herbier de posidonie. Parc National de Port-Cros, Parc Naturel Régional de la Corse et GIS Posidonie publ., Cahier de la découverte n°4 : 80 pp.
- Le Danois E. (1925) - Recherches sur les fonds chalutables des côtes de Tunisie (croisière du chalutier "Tanche" en 1924). Ann. Stat. Océanogr. Salammbô, Tun. : 1-56 + 1 carte h. t.
- Molinier R., Picard J. (1954) - Eléments de bionomie marines sur les côtes de Tunisie. Bull. Stat. Océanogr. Salammbô, Tun., 48: 3-47.
- PNUE (1999) - Plan d'action pour la conservation de la végétation marine en mer Méditerranée. PNUE/PAM-CAR/ASP *édit.* : 47 p.
- Ramos-Esplà A. (1984) - Cartografia de la pradera superficial de *Posidonia oceanica* en la bahia de Alicante (SE, Espana). International Workshop *Posidonia oceanica* beds, Boudouresque C.F., Jeudy de Grissac A. & Olivier J. *édit.*, GIS Posidonie publ : 57-61.

ASSESSMENT OF COASTAL ENVIRONMENTAL QUALITY BASED ON LITTORAL COMMUNITY CARTOGRAPHY: METHODOLOGICAL APPROACH

Xavier TORRAS, Susana PINEDO, Maria GARCIA, Luisa MANGIALAJO and Enric BALLESTEROS

Centre d'Estudis Avançats de Blanes, Acc. Cala Sant Francesc 14, 17300 Blanes, SPAIN

ABSTRACT

In this study we present a new methodology for monitoring water quality based on the cartography of rocky benthic communities in the littoral zone. Littoral communities thriving in the selected coast are cartographed from a small boat and the cartographic information is transcribed to a GIS. With the use of spatial databases and geographic information system technology (GIS) it is possible to know not only the distribution of rocky benthic communities along the coast but also to obtain an environmental quality index giving a "quality" value to every community. This index takes into account the length of the coast covered by each community, a value of ecological quality of each community obtained by expert judgement, and a correction by different parameters other than water quality involved in the distribution of littoral communities (e.g. natural or artificial substrate, type of coast) which has been obtained with an accurate study of the distribution of littoral communities in reference zones. This index, named Ecological Quality Ratio, fulfils the requirements of the Water Framework Directive. (2000/60/EC).

INTRODUCTION

Littoral benthic communities can be used as biological indicators of environmental changes because (1) they are exhaustively studied, at least in the Western Mediterranean and other European coasts, (2) they integrate the environmental changes occurring in marine ecosystems, and (3) they are strongly affected by pollution.

Amongst the organisms that can be used as bioindicators we can point up the seaweeds, which have some species that are good indicators of the environmental quality (e.g. Levine, 1984). There are some studies that show the effects of industrial and wastewater discharges on the macroalgae, mainly regarding the Fucoephyceae, characterized in the Mediterranean Sea by the genus *Cystoseira* (e.g. Bellan Santini, 1968; Soltan *et al.*, 2001). According to Belsher (1977) pollution also affects some red algae, with the disappearance of some species of Gelidiales and Rhodymeniales, and the regression of some Ceramiales, Gigartinales and Cryptonemiales.

We have selected the communities of the littoral zone (mediolittoral and upper infralittoral according to Pérès and Picard, 1964) as biological indicators of the environmental quality of the coastal waters. The community of *Cystoseira mediterranea*

or *Cystoseira amentacea* var. *stricta* has been considered as the most mature community in Mediterranean coastal areas with high to moderate water movement, high irradiance and good water quality. The calcareous formation constituted by *Lithophyllum byssoides* (and other corallines such as *Neogoniolithon brassica-florida*) thriving in waters with very high water movement and relatively low irradiances, does not usually allow the development of the *Cystoseira mediterranea/stricta* community, but this community also indicates a very good water quality. These communities are replaced by other communities dominated by different species of the genus *Cystoseira* or by other brown algae in more sheltered environments. All these communities, that can be considered typical of good-water quality environments are replaced by other communities if water quality decreases. First at all, there is a progressive decrease on the cover of *Cystoseira*, *Lithophyllum byssoides* and other species, which ends in a total replacement of the community. Into moderately to very high hydrodynamic environments the community dominated by *Corallina elongata* (Bellan-Santini, 1968; Ballesteros *et al.*, 1984) and/or mussels (*Mytilus galloprovincialis*) (Bellan-Santini, 1968) is very abundant in waters with a high content of particulate organic matter and nutrients. In some places of the central Mediterranean the simplification of the communities dominated by the genus *Cystoseira* leads to the dominance of another species, *Haliptilon virgatum*. In most jetties and quays with high eutrophication levels, these communities can be present, together with other mediolittoral belts of green and blue-green algae. In other conditions with high nutrient loading (even of natural origin, e.g. very dense seagull colonies) the macroalgae of the genus *Ulva* (Golubic, 1970; Rodríguez-Prieto and Polo, 1996), *Cladophora* (Belsher, 1977) and *Enteromorpha* (Ballesteros *et al.*, 1984) appear, which can finally substitute the belts of *Cystoseira* or even *Corallina*. The replacement of all these communities by species of blue green algae (*Oscillatoria*, *Lyngbya*, *Phormidium*) or *Derbesia* indicates extremely high-degraded environments (Golubic, 1970; Littler and Murray, 1975).

Most studies devoted to determine the environmental quality of an area using communities as indicators use samples that are classified and quantified in the laboratory, or use lists of species with semiquantitative estimates of abundance that are directly obtained in the field. Nevertheless, cartographic methods have also been used in the study of littoral communities. First, cartography was used in marine reserves and other protected areas as a tool to know the distribution of the different communities in order to look for long-term changes (Bianconi *et al.*, 1987; Meinesz *et al.*, 1999). The incorporation of GIS methodology in this kind of studies has allowed more accurate cartographies and has made easy the data analysis in order to correlate the extension of the communities with other data (e.g. geomorphology, pollution...) (Mangialajo, 2000; Soltan, 2001). The establishment of a reference network of high status sites permits to estimate the ecological status and adjust this methodology to the Water Framework Directive (2000/60/EC).

DESCRIPTION OF THE METHOD

Sampling is performed in the totality of the rocky areas present in the selected coast. Sedimentary areas are not considered in this methodology if they are devoid of any apparent animal or vegetal coverage, as it is usually the case (with the exception of extremely sheltered environments and coastal lagoons where seagrasses or certain species of seaweeds can be abundant). We do not take into account highly man-modified water environments such as the inner part of harbours and marinas, which do not reflect the environmental quality of the adjacent coast.

The dimension of the sector of the coast to be used as a unit is difficult to precise because of the different coastal morphologies and of its fractal structure. However, and according to the length of the coast where we have applied this methodology, we have estimated this unit as 50 meters of coast length smoothed to the course of a pneumatic boat at a distance of 3 meters of the coastline. Therefore, the whole coast is surveyed with a pneumatic boat and the different units (communities or combination of communities) that are observed are directly indicated in aerial photographs, nautical charts or ortho-photographs. This graphic support has to be of an appropriate scale (in our case enough to differentiate the 50 meter sectors, that is 1:10.000 or 1:5.000) and suitable to be easily used in a small boat. Most of the sampling should be performed in a rather reduced time scale (e.g. one to two months) in order to avoid the great seasonal variability that is usually associated to these littoral communities. In the Northwestern Mediterranean the best months to make this kind of study are May and June, but this may vary when considering other geographical areas.

In our study we have differentiated the following units:

- Cystoseira 5: The belt of *Cystoseira mediterranea* / *stricta* is continuous, with a high density of *Cystoseira* plants.
- Cystoseira 4: The belt of *C. mediterranea* / *stricta* is continuous only in the places that are most suitable for this species.
- Cystoseira 3: The belt of *C. mediterranea* / *C. stricta* is not continuous, and density of *Cystoseira* is only high in the places that are most suitable for this species. There are some small sectors that can be devoid of *Cystoseira* or, if present, it is represented by isolated plants.
- Cystoseira 2: *C. mediterranea* / *C. stricta* never attains high densities and, therefore, a clear belt of this species is inexistent (with the possible exception of some isolated and small patches in very few places very suitable for this species). The isolated plants are usual, even abundant.
- Cystoseira 1: Only scattered plants of *C. mediterranea* / *C. stricta* are present, growing inside other communities. There are no patches, even of very small size, where a *Cystoseira* belt can be described.

Lithophyllum byssoides – formation ("trottoir"): Present in places with high hydrodynamism and steep slope. The growth of *Lithophyllum byssoides* creates an overhang in the upper infralittoral level that prevents the growth of *Cystoseira*.

Cystoseira spp. (sheltered environments): Mainly characterized by *Cystoseira crinita*, *C. brachycarpa*, *C. elegans* but also by other species of the same genus. The same categories used for *C. mediterranea* can be used.

Cystoseira compressa: Belt of *Cystoseira compressa*, it can also be distinguished in the 5 categories we have used for *C. mediterranea* / *C. amentocea* var. *stricta*.

Posidonia oceanica: Barrier reefs of *Posidonia oceanica*, whose leaves attain the water surface can be observed in sheltered environments, usually together with *Cystoseira* spp.

Cymodocea nodosa: Meadows dominated by this species in very sheltered environments, over sand, mud or gravel.

Zostera noltii: Meadows dominated by this species in extremely sheltered environments, usually over muddy and silty bottoms.

Corallina elongata: This unit is characterized by the dominance of this species, which is widespread in the Northwestern Mediterranean, but always with the absence of *Cystoseira*. In fact, the categories 1 and 2 of *Cystoseira* should be usually attributed to this or other communities with the presence of some *Cystoseira* individuals.

Halimtilon virgatum: Community dominated by this species, sometimes with *Dictyota fasciola* and *Laurencia microcladia*. Absence of *Cystoseira* plants.

Mytilus galloprovincialis: Mussel beds, without *Cystoseira*.

Green algae: Green littoral belts dominated by *Ulva*, *Cladophora* without *Cystoseira*.

Encrusting corallines : Belts dominated by the encrusting corallines *Lithophyllum incrustans*, *Neogoniolithon brassica-florida*, and, even, crusts of *Corallina elongata*.

Blue green algae: The dominant species are blue green algae, perhaps with some ulvacean algae and *Derbesia tenuissima*.

The presence/absence and abundance of every community is determined not only by pollution or other anthropogenic disturbances but also by the natural environment. Therefore, different geomorphological parameters that most probably are involved in the establishment and/or development of the communities have to be evaluated in order to account for this natural variability. The geomorphological factors that we have considered are the following:

- Coastline morphology: continuous rock, blocks, stones...
- Substrate constitution: calcareous, basaltic, granitic...
- Coastline slope
- Coastline orientation
- Natural\Artificial
- Degree of wave exposure
- Height of the sea-cliffs

Based on the previous knowledge (expert judgement), obtained by other methods or by the available literature, and for every community or unit we have established a direct correspondence between units and quality based on the vulnerability in front of natural or anthropic disturbances. Each unit or combination of units must have a "quality" value. In our first approach we established a scale from 1 to 20 (table 1), but is possible to use any other scale. Thus, the assessment of the environmental quality of a concrete sector of coastline can be estimated as:

$$EQV = \frac{\sum (l_i * x_i)}{\sum l_i}$$

where,

EQV: Environmental Quality Value of a stretch of coastline.

Li: length of the coastline occupied by the unit i.

Xi: assessment of the quality value of the unit.

Table 1: Examples of quality values for different communities found in the coasts of Catalonia.

UNIT(i)	VALUE(xi)
Cystoseira 5	20
"Trottoir" <i>L. lichenoides</i>	20
Cystoseira 3	15
<i>Corallina elongata</i>	8
<i>Mytilus galloprovincialis</i>	8
<i>Lithophyllum incrustans</i>	6
Green algae	3
Blue-Green algae	1

The cartographic information obtained has to be transcribed, as accurately as possible, to a GIS. This GIS must have a geo-referenced graphical support (e.g. orto-photographs), and the coastline must be generated over this graphical support. The coastline has to be divided in sectors, and we assign a community category and the values of the different parameters for every single sector of coast.

The Mediterranean coastline is, in some places, subject to great anthropogenic modifications. Thus, coastlines coming from different graphical supports can be different and even have strong changes from one year to another (creation of new harbours or jetties, dredging, beach regeneration). These changes have to be taken into account when transcribing the data and the graphical support has to be modified accordingly from year to year.

As established by the WFD (2000/60/EC) in order to ensure comparability between the values obtained by different monitoring systems an ecological quality ratio (EQR) has to be calculated. These ratios represent the relationship between the values observed in the study site and the values observed in the reference sites.

$$EQR = \frac{\text{Relation of observed values of biological parameters}}{\text{Reference values of the biological parameters}}$$

The reference sites have to be selected based on 1) their undisturbed or very minor disturbed state and 2) their similar physico-chemical and hydrogeomorphological conditions with the valuated site. In our case, the reference network for the Catalan coast is formed by three different high status sites: 1) Façade maritime du Parc Naturel Régional de Corse, 2) Reserva dels Freus de Formentera i Eivissa and 3) Reserva del Nord de Menorca. These three reference sites were cartographed in 2001.

The comparison between the Catalan coast and the reference sites has to be made sector by sector. First at all, it is important to assess which are the geomorphological factors that affect the presence/absence or dominance of the different communities. A MDS analysis was performed in the reference sites regarding all the different situations (e.g. 174 in our study) resulting from all the combinations of the geomorphological variables considered and the percentage of coast occupied by each community for each situation.

Results of this MDS analysis shows that "Coastline morphology" (Fig. 1) and "Natural\Artificial" (Fig. 2) are the most important parameters in the determination of the littoral benthic communities in the reference sites. The combination of these parameters permits to define six different "geomorphological relevant situations" (table 2). The value of EQV has been calculated for everyone of these situations (table 2).

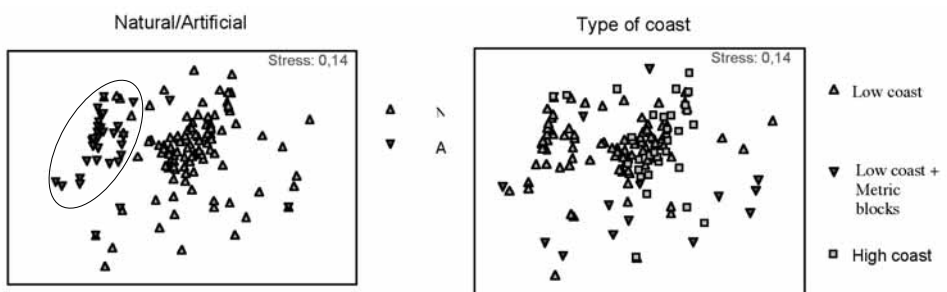

Fig. 1 : MDS analysis: distribution of the 174 different situations resulting from all the available combinations of the geomorphological variables considered in reference sites according to the percentage of coast occupied by each community for each situation. Artificial and natural substrates are indicated with different symbols.

Fig. 2 : MDS analysis: distribution of the 174 different situations resulting from all the available combinations of the geomorphological variables considered in reference sites according to the percentage of coast occupied by each community for each situation. Decimetric blocks, low coast and high coast are indicated with different symbols.

Table 2: Ecological quality values calculated for the six geomorphological relevant situations in reference conditions

Situation	Type of coast	N/A	EQV
1	Decimetric blocks	Artificial	12,06
2	Low coast	Artificial	11,86
3	High coast	Artificial	8,00
4	Decimetric blocks	Natural	12,20
5	Low coast	Natural	16,61
6	High coast	Natural	15,25

The EQR of every sector of coast to be evaluated was calculated based on the relation between the EQV obtained in the study site and the EQV in the reference sites corresponding to the same "geomorphological relevant situation". Therefore, the EQR of a coast is calculated according to the following formula:

$$EQR = \frac{\sum \frac{EQV_{ss_i} * l_i}{EQV_{rs_i}}}{\sum l_i}$$

where:

i : situation

EQV_{ss_i}: EQV in the study site for the situation i

EQV_{rs_i}: EQV in the reference sites for the situation i

l_i: Coastal length in the study coast for the situation i

The EQR is a value quoted from 1 to 0. We classify the range of values in 5 categories of disturbance and status (table 3) that are expressed in five different colors in the maps: blue for high, green for good, orange for moderate, yellow for poor and red for bad ecological status

Table 3: Degree of disturbance and ecological status for different intervals of the Ecological quality ratio

EQR	Disturbance	Status
>0,75 - 1,00	No or very minor	High
>0,60 - 0,75	Slight	Good
>0,40 - 0,60	Moderate	Moderate
>0,25 - 0,40	Major	Poor
0,0 - 0,25	Severe	Bad

EXAMPLE

This methodology has been applied to the coast of Catalonia. Data was collected in spring 2002. The geomorphological parameters were evaluated in year 2001, together with the geomorphological and community cartography of the reference sites. Here, we present the EQR corresponding to different regions, although it can also be obtained for municipalities or other geographical or management-based units (Fig. 3).

The result of the EQR for the littoral regions in Catalonia in year 2002 shows that the ecological status of the northern coast is high, while the center and the south coast have a moderate status, except for the region of "Tarragonès" with a good status. The region "Baix Llobregat" has not been evaluated since its shoreline is completely sandy.



CONCLUSIONS

The cartography of the littoral communities permits to know the distribution of these communities along the coast and the monitoring of the ecological status of coastal waters within the WFD monitoring programs. The sampling of data is relatively quick and, as a visual method, it is non destructive. It is also important to point out that is continuous and every piece of rocky coast can be evaluated. Nevertheless, coasts devoid of any kind of macroscopic vegetation cannot be evaluated (e.g. sandy shores).

ACKNOWLEDGMENTS

This study has been financed by the Water Catalan Agency (ACA) of the Environmental Department of the Generalitat of Catalonia

REFERENCES

- Ballesteros E., Pérez M., Zabala M. (1984) - Aproximación al conocimiento de las comunidades algales de la zona infralitoral superior en la costa catalana. *Collect. Bot.*, 15 : 69-100.
- Bellan-Santini D. (1968) - Influence de la pollution sur les peuplements benthiques. *Rev. Intern. Oceanogr. Med.*, 10 : 27-53.
- Belsher T. (1977) - Analyse des répercussions de pollutions urbaines sur les macrophytobenthos de Méditerranée (Marseille, Port-Vendres, Port-Cros). Thèse Doctorat 3^o cycle. Université d'Aix_Marseille II. : 287 pp.
- Bianconi H., Boudouresque C. F., Meinesz A., Di-Santo F. (1987) - Cartographie de la repartition de *Lithophyllum lichenoides* (Rhodophyta) dans la réserve naturelle de Scandola (côte occidentale de La Corse, Méditerranée). *Trav. Sci. Parc. Nat. Rég. Rés. Nat. Corse*, 13 : 39-63.
- Golubic S. (1970) - Effect of organic pollution on benthic communities. *Mar Poll. Bull.*, 1:56- 57.
- Levine H.G. (1984) - The use of seaweeds for monitoring coastal waters. Algae as ecological indicators, ed. L. E. Shubert, Academic Press. London : 189 - 210
- Littler M. M., Murray S. N. (1975) - Impact of sewage on the distribution, abundance and community structure of rocky intertidal macro-organisms. *Mar. Biol.*, 30:277-291.
- Mangialajo L. (2000) - Area Marina Protetta (A.M.P.) del Promontorio di Portofino: Applicazione di un geographical information system (G.I.S.) alla distribuzione delle comunità superficiali. Università degli studi di Genova.
- Meinesz A., De Vaugelas J., Chiaverini D., Bialecki K., Cottalorda J. M., Komatsu T., Molenaar H. (1999) - Représentation cartographique de l'abondance de quelques algues et invertébrés du littoral de la réserve naturelle de Scandola (Corse). *Ed Lab. Envir. Mar. Litt., U.N.S.A.* pp. 1-69.
- Pérès J. M., Picard J. (1964) - Nouveau manuel de bionomie benthique de la Mer Méditerranée. *Rec. Trav. St. Mar. Endoume*, 31:5-137.
- Rodriguez-Prieto C., Polo L. (1996) - Effects of sewage pollution in the structure and dynamics of the community of *Cystoseira mediterranea* (Fucals, Phaephyceae). *Sci. Mar.*, 60:253-263.
- Soltan D. (2001) - Etude de l'incidence de rejets urbains sur les peuplements superficiels de macroalgues de Méditerranée nord-occidentales. These doctorat. Université de la Méditerranée.
- Soltan D., Verlaque M., Boudouresque C. F., Francour P. (2001) - Changes in macroalgal communities in the vicinity of the mediterranean sewage outfall after the setting up of a treatment plant. *Mar. Poll. Bull.* 42: 59-70.

CYTOSEIRA SPP. ASSOCIATIONS IN THE NORTH-EASTERN MEDITERRANEAN: THE CASE OF EVOIKOS GULF (CENTRAL AEGEAN SEA, GREECE)

Ioanna VARKITZI¹, Panayotis PANAYOTIDIS¹ and Barbara MONTESANTO²

¹ Hellenic Centre for Marine Research, Institute of Oceanography, POB 712, Anavissos 19013, Greece

² Athens University, Section of Ecology & Taxonomy, Panepistimiopolis 15784, Athens, Greece

Ioanna Varkitzi: e-mail address: ioanna@ath.hcmr.gr

ABSTRACT

The species composition of the *Cystoseira* associations was studied on a gradient of decreasing wave energy (from the exposed southern part of the gulf to the sheltered northern part). Samplings were carried out at four sites of the Greek NATURA 2000 network. Phytosociological analysis and statistical treatment grouped together the two sites at the exposed and transitional part of the gulf. In these sites the dominant species was *Cystoseira crinitophylla* and this association corresponded to *Cystoseiretum crinitae* Molinier 1958. The two sheltered sites formed two distinct groups. The dominant species was *Cystoseira foeniculacea* f. *tenuiramosa* but the accompanying species were different. Despite the absence of *C. sauvageauana*, the accompanying species make these two aspects similar to *Cystoseiretum sauvageauanae* Giaccone 1994. However, they do not correspond clearly to any of the *Cystoseira* associations described so far. Therefore, they could indicate a new type of *Cystoseiretum sauvageauanae* or even a new association.

KEYWORDS: *Cystoseira*, NATURA 2000, Mediterranean, Aegean

INTRODUCTION

The genus *Cystoseira* C. Agardh (Fucales, Phaeophyceae) is part of the biological identity of the Mediterranean Sea (Roberts, 1978). *Cystoseira* species are the dominant element of the photophilic algal associations on undisturbed hard substrates of the upper infralittoral zone (Margalef, 1985). Many studies have dealt with the photophilic *Cystoseira* associations of the W Mediterranean so far (Feldmann, 1937; Molinier, 1960; Giaccone, 1968; Boudouresque, 1969; Verlaque, 1988; Ballesteros, 1990b; Giaccone and Bruni, 1973; Cormaci *et al.*, 1992; Rodriguez and Polo, 1996). In the Eastern Mediterranean, Huvé (1972) first studied the distribution and ecology of the *Cystoseira* species in the Aegean Sea. Following researches added more information about the phytosociology, phytogeography and ecology of the *Cystoseira* species in the Greek coastal areas (Haritonidis, 1978; Athanassiadis, 1987; Montesanto and Panayotidis, 2000).

Pères and Picard, (1964) suggested that the algal associations of the genus *Cystoseira* should be considered as the final stage (climax stage) in the ecological succession of the photophilic algal associations in the Mediterranean. Striking differences have been found by

several authors between the dominant *Cystoseira* species as well as the accompanying algal species, under different environmental conditions (Giaccone and Bruni, 1973)

The present study focuses on the changes in the composition of the algal associations dominated by the genus *Cystoseira*, along a gradient of decreasing wave energy in a North Eastern Mediterranean endayment.

MATERIALS AND METHODS

Four sampling sites were chosen as representatives of a gradient of decreasing wave energy in Evoikos gulf, central Aegean Sea. Site 1 was located at the most exposed part of the gulf on a typical rocky coast. Site 2 was again located on a typical rocky coast at the transitional part of the gulf (from the open to the inner part) and was therefore moderately exposed. Site 3 was located at the moderately sheltered part of the gulf. The hard substrate here was boulders dispersed on a sandy seafloor. Site 4 was a tidal flat with high sedimentation and turbidity. It was located at the most sheltered part of the gulf. The hard substrate was limited to big cobbles dispersed on muddy sand.

The samples were collected from the upper infralittoral zone (0.3-1m depth) with free diving in September-October 2000. Four replicates were collected from each site with destructive sampling of a quadrat of 400 cm² surface (20cm x 20cm). This is considered to be the minimal representative sampling area for the photophylic algal associations of the Mediterranean (Dhont and Coppejans, 1977; Boudouresque and Belsher, 1979). The samples were fixed with a Formol-natural seawater solution (4%).

The species were identified microscopically at the Hellenic Centre for Marine Research. The classifications proposed by Ribera *et al.* (1992) for the Phaeophyceae, Gallardo *et al.* (1993) for the Chlorophyta and Athanasiadis (1987) for the Rhodophyta were followed. The species abundance was determined in terms of total and relative surface coverage per sample and site. The Shannon- Weaver diversity index (1963), the Pielou evenness index (1969) and the Bray-Curtis similarity index (1957) were computed with the use of the PRIMER 5 software. Hierarchical clustering and MultiDimensional Scaling (MDS) from the Bray-Curtis similarity matrix were plotted on a dendrogram and an MDS projection.

RESULTS

The number of species, the coverage and the ecological indices are presented in Table 1. A detailed list of the species with mean values of coverage and relative coverage from the four sites are shown in Table 2.

Table 1: Numbers of species, mean values±SE of the coverage, the diversity and the evenness indices from the four replicates of each site

	Species number	Coverage	Diversity (H')	Evenness (J')
SITE 1	38	355,04±24,10	3,29±0,16	0,75±0,06
SITE 2	56	341,11±45,89	3,85±0,12	0,79±0,03
SITE 3	42	217,00±35,48	2,64±0,34	0,61±0,07
SITE 4	28	146,36±38,48	2,83±0,11	0,66±0,02

Table 2 : List of the species, mean values of coverage (MC) and relevant coverage (MRC) from the four replicates of each site

	SITE 1		SITE 2		SITE 3		SITE 4	
	MC	MRC	MC	MRC	MC	MRC	MC	MRC
CHLOROPHYTA								
<i>Acetabularia acetabulatum</i>							7,50	4,63
<i>Anadycomene stellata</i>	2,00	0,56	1,25	0,42	15,13	4,73	0,38	0,39
<i>Chaetomorpha aerea</i>			0,05	0,02	0,03	0,02	0,27	0,17
<i>Cladophora pellucida</i>			0,25	0,08	3,00	1,46		
<i>Cladophora prolifera</i>			1,25	0,27				
<i>Cladophora sp1</i>	0,25	0,06						
<i>Cladophora sp2</i>			3,13	0,72				
<i>Cladophora sp3</i>			0,33	0,13				
<i>Cladophora sp4</i>					23,25	11,88	7,30	5,63
<i>Dasycladus vermicularis</i>	0,08	0,02	0,01	0,01	2,50	0,78	5,29	3,68
<i>Esteromorpha sp</i>							0,16	0,12
<i>Halimeda tuna</i>	0,50	0,16	15,63	4,70				
<i>Pseudochlorodesmis furcellata</i>			1,00	0,28				
<i>Valonia utricularis</i>	0,88	0,23	0,43	0,14	1,00	0,50	1,12	0,93
<i>Udotea petiolata</i>	1,50	0,48	1,50	0,50				
coverage of Chlorophyta	5,20	1,51	24,81	7,27	44,90	19,37	22,21	15,55
PHAEOPHYCEAE								
<i>Cystoseira compressa</i>	35,00	9,52	5,75	1,87				
<i>Cystoseira crinitophylla</i>	82,50	23,61	59,25	18,04				
<i>Cystoseira foeniculacea f. tenuiramosa</i>					97,50	48,98	58,13	40,52
<i>Dictyota dichotoma</i>			1,00	0,29	1,50	0,59		
<i>Dictyota dichotoma var. intricata</i>					0,25	0,13		
<i>Dictyota linearis</i>					0,33	0,23		
<i>Halopteris filicina</i>			0,25	0,07				
<i>Fadina pavonica</i>			5,00	1,39				
<i>cf. Ralfsia verucosa</i>					0,08	0,05	0,33	1,22
<i>Sargassum vulgare</i>			9,00	3,42				
<i>Sphaelaria furgicera</i>	2,75	0,77						
<i>Sphaelaria citrosa</i>	22,50	6,17	29,00	8,78	14,38	6,18	2,10	1,51
<i>Stylocaulon scoparium</i>			1,25	0,32				
coverage of Phaeophyceae	142,75	40,06	110,50	34,19	114,03	56,17	60,55	43,25
RHODOPHYTA								
<i>Asidium helminthochorton</i>			2,50	0,54				
<i>Amphiroa rigida</i>	0,50	0,16						
<i>Astirhammon sp</i>					0,50	0,15		
<i>Botryocladia botryoides</i>	0,06	0,02	0,15	0,06				
<i>Bryocantia byssoides</i>					0,88	0,42		
<i>Callithammon corymbosum</i>	0,01	0,00	0,75	0,22				
<i>Callithammon tetragonum</i>					0,05	0,03		
<i>Ceramium ciliatum</i>			0,13	0,11				
<i>Ceramium circinatum</i>	0,35	0,09						
<i>Ceramium diaphanum</i>	1,78	0,50	2,60	0,84	0,25	0,08		
<i>Ceramium flaccidum, f. gracillimum</i>	2,25	0,66	0,50	0,37	4,50	1,90		
<i>Ceramium tenuissimum</i>			1,25	1,08	1,25	0,64		
<i>Ceramium tenuissimum, f. repens</i>					0,38	0,36		
<i>Ceramium tenuissimum</i>							8,25	5,92
<i>Champia parvula</i>	3,43	0,97	0,13	0,11				
<i>Chondria dasphyllia</i>			2,50	2,16	2,25	1,20	8,03	6,16
<i>Chondria sp</i>	0,08	0,02						
<i>Chondria tenuissima</i>	1,50	0,48						
<i>Corallina elongata</i>			11,55	3,01				
<i>Corallina granifera</i>	41,00	11,78	12,38	3,87	1,25	0,55		
<i>Crouania attenuata</i>					0,75	0,27		
<i>Dasya rigidula</i>	0,14	0,04	1,00	1,13	1,00	0,48		
<i>Dipterosiphonia rigens</i>	3,25	1,03						
<i>Bythotrichia carnea</i>	0,15	0,04	0,18	0,04	0,03	0,02		
<i>Posidella farinosa</i>	14,50	3,89	11,33	3,12	2,88	0,97	0,87	0,56
<i>Gelidium pusillum</i>			0,33	0,52	2,63	1,57		
<i>Gelidium latifolium</i>			8,50	3,49				
<i>Gonotrachelum alsidi</i>	0,03	0,01	0,01	0,01	0,01	0,01		
<i>Griffithsia barbata</i>			1,50	1,70				
<i>Griffithsia tenuis</i>	0,28	0,07			5,68	2,42	0,01	0,00
<i>Herposiphonia secunda</i>	11,25	3,32	10,50	2,50			0,35	0,20
<i>Herposiphonia tenella</i>			3,38	5,40	1,45	0,83	1,07	0,76
<i>Heterosiphonia crispella</i>			0,50	0,67	2,50	0,77		0,01
<i>Jania rubens</i>	62,00	17,69	41,00	11,50	15,50	5,87	0,82	0,51
<i>Laurencia obtusa</i>	10,68	2,99	39,08	11,11	0,25	0,24	2,10	1,41
<i>Laurencia papillosa</i>			0,13	0,14				
<i>Lejolia mediterranea</i>	0,25	0,08	2,25	3,60	1,50	0,96	0,01	0,00
<i>Lithophyllum sp</i>	4,38	1,29	7,25	2,59	0,20	0,16	0,71	0,50
<i>Lophosiphonia cristata</i>	13,25	3,52			0,75	0,46		
<i>Lophosiphonia obtusa</i>							0,43	0,29
<i>Lophosiphonia scopulorum</i>			0,50	0,57				
<i>Lophosiphonia subadunca</i>	12,50	3,58			3,00	1,29		
<i>Polysiphonia breviarticulatae</i>							10,12	6,19
<i>Polysiphonia brodiaei</i>	0,05	0,02	1,43	2,28				
<i>Polysiphonia furcellata</i>			2,50	2,83				
<i>Polysiphonia opaca</i>							23,68	15,88
<i>Polysiphonia sanguinea</i>					0,75	0,77		
<i>Polysiphonia sertularioides</i>			2,13	0,96	0,05	0,05	3,42	2,72
<i>Polysiphonia setacea</i>	10,00	2,49	20,95	5,80	5,65	2,54	2,10	1,64
<i>Polysiphonia subulifera</i>			4,25	5,69				
<i>Polysiphonia tenerima</i>	2,50	0,72	0,40	0,64	0,50	0,48		
<i>Polysiphonia tripinnata</i>			1,75	1,05				
<i>Phloerhammon plumum</i>							0,03	0,02
<i>Spermothammon Rabellatum</i>			0,75	0,85				
<i>Spermothammon Isajolisi</i>					1,00	0,62		
<i>Spyridia filamentosa</i>					1,00	0,82	0,68	0,38
<i>Spyridia sp</i>			0,01	0,01				
<i>Titanoderma cystoseirae</i>	12,38	3,28	9,80	2,66			0,95	0,62
<i>Wrangelia penicillata</i>	0,08	0,02						
coverage of Rhodophyta	208,59	58,77	205,80	58,43	58,37	24,52	63,61	43,76
TOTAL coverage	356,54	100,34	341,11	99,89	217,00	100,12	146,36	100,00

Fig. 1: presents the results of Bray-Curtis similarity clustering. An MDS plot from the Bray-Curtis similarity matrix is presented in Figure 2

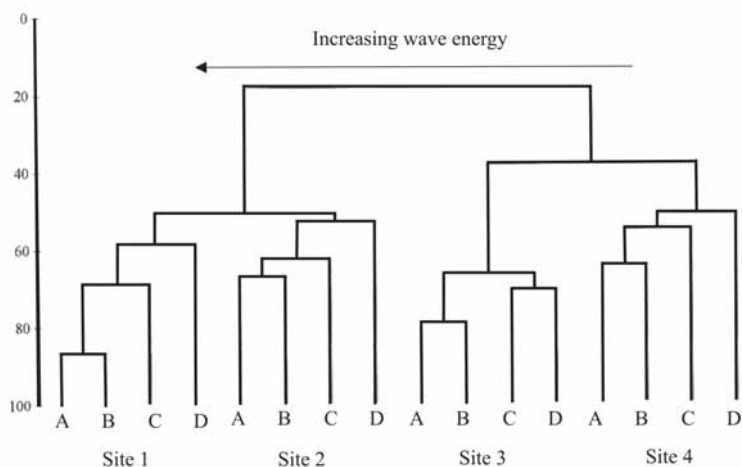

Fig. 1: Similarity (%) among the replicates and the sites

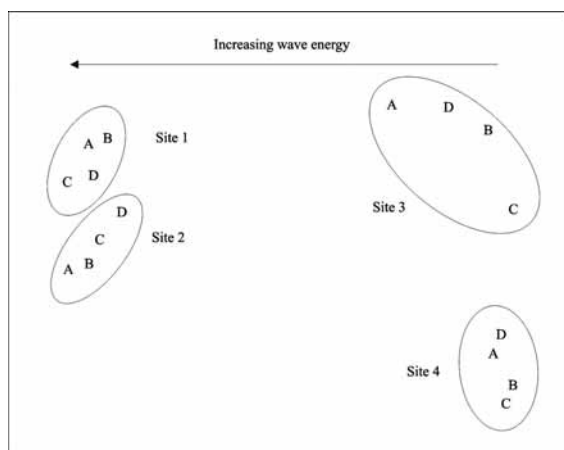

Fig. 2: MDS plot. A-D are replicates of each site

DISCUSSION

The highest number of species was found in the moderately exposed site (Site 2) and the lowest in the most sheltered (Site 4). Interestingly the Rhodophyta represent the highest number of species in all four sites, with the highest number in Site 2, while Phaeophyceae represent the lowest. The highest values of Shannon-Weaver diversity index and Pielou evenness were observed in Site 2 and the lowest in Site 3 (the moderately sheltered site).

Under high wave energy, *Cystoseira crinitophylla* was dominant. This result is in accordance with previous observations from the Aegean (Montesanto and Panayotidis, 2000). The accompanying species are less abundant in Site 1 than in Site 2 probably because the high wave energy of Site 1 plays a limiting role on the settlement of seasonal or opportunistic species. This lack of competition for *C. crinitophylla* in Site 1 could also account for the highest coverage found in this site. The *Cystoseira* association in Site 2 is more balanced. The moderate wave energy here is not a limiting factor for the settlement of other species. This could explain the highest numbers of species and coverage for Rhodophyta and therefore the highest values of the diversity and evenness indices. The numbers of species for Phaeophyceae were the highest in Site 2 as well.

The hierarchical clustering that derived from the Bray-Curtis similarity matrix gave the dendrogram presented in Figure 1. The replicates of each site are grouped together with high similarity values. Sites 1 and 2 (high wave energy) formed one group (similarity 50.76%). In the MDS plot (Figure 2), the Euclidean distances among the sites give us more information. Sites 1 and 2 are strongly grouped together.

The *Cystoseira* associations in these two sites construct typical aspects of the *Cystoseiretum crinitae* Molinier 1958. This is a common association for moderately exposed coasts of the Mediterranean with most frequent species *C. crinita* and *C. compressa* (Giaccone and Bruni, 1973). In the Aegean Sea, Montesanto and Panayotidis (2000) have found that *C. crinitophylla* replaces *C. crinita* in highly or extremely exposed areas.

C. foeniculacea f. tenuiramosa was the dominant species in the moderately sheltered site (Site 3). This species is obviously tolerant to the conditions of low wave energy. In addition, the re-suspension of the fine sand among the boulders could create high turbidity conditions. Ercegovic (1952) suggested that *C. foeniculacea f. tenuiramosa* (= *C. schiffneri f. tenuiramosa*) is favored by conditions of low wave energy and transparency. The poor contribution of the accompanying species to this *Cystoseira* association and the very high coverage of *C. foeniculacea f. tenuiramosa* probably account for the lowest values of the diversity and evenness indices here. *C. foeniculacea f. tenuiramosa* was the dominant species in the most sheltered site (Site 4). The lowest number of species and the lowest total coverage were found here as well.

In the dendrogram of Fig. 1, Sites 3 and 4 (low wave energy) formed another distinct group with lower similarity (38.39%) than Sites 1 and 2. In the MDS plot, Sites 3 and 4 formed two distinct groups. The lower similarity here could be attributed to the presence of different epiphytic species in the two sites.

Cystoseira schiffneri has a problematic taxonomy (Ercegovic, 1952). The associations of *C. foeniculacea* and *C. barbata* were first described by Feldmann (1937) in protected areas where the hard substrate was occasionally covered by sediments. Athanassiadis (1987) also found *C. foeniculacea* in protected sites often. Montesanto and Panayotidis (2000) found that *C. foeniculacea* (= *C. schiffneri*) accompanies *C. crinita* and *C. compressa* in sheltered or moderately exposed sites in the Aegean.

The *Cystoseira* associations in these two sites do not correspond clearly to any of the associations described so far from the Mediterranean. Giaccone and Martino (2000)

suggested the association *Cystoseiretum sauvageauanae* Giaccone 1994 (Ord. Cystoseiretalia, All. *Cystoseirion crinitae*) with *C. sauvageauana*, *C. foeniculacea* f. *tenuiramosa* (= *C. schiffneri* f. *tenuiramosa*) and *Stilophora rhizodes* as dominant species. Moreover the accompanying species that we found in the *Cystoseira* associations from the moderately and very sheltered sites correspond to a previous more detailed description of *Cystoseiretum sauvageauanae* by Giaccone and Bruni (1973). However, these authors reported that *C. sauvageauana* was replaced by *C. corniculata* in the E Mediterranean. In addition, the *Cystoseiretum sauvageauanae* described from the E Mediterranean (Aegean Sea) was reported from high wave energy conditions (Huvé, 1972, Montesanto and Panayotidis, 2000). For these reasons, the associations we found with *C. foeniculacea* f. *tenuiramosa* as the dominant species could possibly consist a new type of *Cystoseiretum sauvageauanae* or even a new association. This conclusion highlights the need for further research on the *Cystoseira* associations of the E Mediterranean.

ACKNOWLEDGEMENTS

This research was financed by the Greek Ministry of Environment in the framework of the elaboration of the Greek part of the European "NATURA 2000" network.

REFERENCES

- Athanassiadis A. (1987) - A survey of the seaweed of the Aegean sea with taxonomic studies on the species of the tribe Antiathamnieae (Rhodophyta). PhD Thesis. Univ. of Göthenburg : 174pp
- Ballesteros E. (1990) - Structure and dynamics of North-Western Mediterranean phyto-benthic communities: a conceptual model. *Oecol. Aquat.*, 10 : 223-242.
- Boudouresque C. F. (1969) - Etude qualitative et quantitative d'un peuplement algale à *Cystoseira mediterranea* dans la région de Banyuls sur Mer. *Vie et Milieu*, 20 : 437-452.
- Bray J.R., Curtis J.T. (1957) - An ordination of the upland forest communities of southern Wisconsin. *Ecol. Monogr.*, 27 : 325-349.
- Boudouresque C. F., Belsher T. (1979) - Le peuplement du port de Port-Vendres: recherches sur l'aire minimale qualitative. *Cahiers de Biologie Marine*, 20 : 259-269.
- Cormacci M., Furnari G., Giaccone G., Scammacca B., Serio D. (1992) - Observations taxonomiques et biogéographiques sur quelques espèces du genre *Cystoseira* C. Agardh. *Bull. de l'Institut. Océan.*, Monaco, 9 : 21-35.
- Dhont F., Coppejans E. (1977) - Résultats d'une étude d'aire minima des peuplements algaux photophiles sur substrat rocheux à Port-Cros et à Banyuls/Mer (France). *Rapp. Comm. Int. Mer Médit.*, 24(4) : 141-142.
- Ercegovic A. (1952) - Jaadranske Cistosire. Njihova morfologija, ekologija I razvitak. *Fauna I Flora Jadrana*, Split, 2 : 212pp.
- Feldmann J. (1937) - Recherches sur la végétation marine de la Méditerranée. *Rev. Algol.*, 10 : 1-339.

Giaccone G., Bruni A. (1973) - Le Cistoseire e la vegetazione sommersa del Mediterraneo. Atti dell'Istituto Veneto di Scienze, Lettere ed Arti : 60-103.

Giaccone G., Di Martino V. (2000) - Past, present and future of vegetational diversity and assemblages on Mediterranean Sea. First Mediterranean Marine Vegetation Symposium, RAC/SPA, UNEP, Corsica 3-4/10/2000 : 1-24.

Giaccone G. (1968) - Contributo allo studio fitosociologico dei popolamenti algali del Mediterraneo orientale. Giorn. Bot. Ital., 102 : 485-506.

Haritonidis S. (1978). A survey of the marine algae of Thermaikos Gulf, Thessaloniki, Greece. Bot. Mar., 21 : 527-535.

Huve E. (1972) - Aperçu sur la distribution en Mer Egée de quelques espèces du genre *Cystoseira*. Société Phycologique de France, 15 : 22-37.

Margalef R. (1985) - Western Mediterranean. Pergamon Oxford Press. : 262pp.

Molinier R. (1960) - Etudes des biocénoses marines du Cap Corse. Vegetation, 9 : 121-192 & 217-312

Montesanto B., Panayotidis P. (2000) - The *Cystoseira* spp. communities from the Aegean Sea (NE Mediterranean). J. Mar. Biol. Ass. U.K., 80 : 357-358.

Peres J. M., Picard J. (1964) - Nouveau manuel de bionomie benthique de la mer Méditerranée. Rec. Trav. St. Mar. Endoume, 31(47) : 5-137.

Pielou E. C. (1969) - The measurement of diversity in different types of biological collections. Journal Theoretic Biology, 13 : 131-144.

Roberts M. (1978) - Active speciation in the taxonomy of the genus *Cystoseira* C. Ag. Modern approaches to the taxonomy of red and brown algae, London, Academic Press : 399-422.

Rodriguez-Prieto C., Polo L. (1996) - Effects of sewage pollution in the structure and dynamics of the community of *Cystoseira mediterranea* (Fucales, Phaeophyceae). Sci. Mar., 60(2-3) : 253-263.

Shannon C. E., Weaver W. (1963) - The mathematical theory of communication. Urbana University Press, Illinois.

Verlaque M. (1988) Végétation marine de la Corse. (Méditerranée). Bot. Mar., 31(2) : 187-194.

SESSION «ANTHROPOGENIC IMPACTS
ON MARINE VEGETATION IN THE
MEDITERRANEAN»

*SESSION «IMPACTS ANTHROPIQUES
SUR LA VEGETATION MARINE DE
MEDITERRANEE»*

CARACTERISATION DE L'ETAT DES HERBIERS A *POSIDONIA OCEANICA* (L.) DELILE DU NORD-EST DES ILES KERKENNAH (TUNISIE)

Soumaya EL HERRY¹, Mohamed Salah ROMDHANE¹, Chedly RAÏS² et Amel BEN REJEB JENHANI¹

¹ Institut National Agronomique de Tunisie (INAT)

² Centre d'Activités Régionales pour les Aires Spécialement Protégées – Tunis (CAR/ASP)

RESUME

Le présent travail présente les résultats relatifs à la caractérisation de l'état de l'herbier de Posidonies de la zone Nord Est des îles Kerkennah, moyennant l'étude de la phénologie et de la lépidochronologie, au niveau de six stations réparties dans la zone d'étude. La majorité des feuilles examinées sont des feuilles adultes. Le nombre moyen de ces feuilles par faisceau varie entre un minimum de 5.3 et un maximum de 6.8. La longueur moyenne des feuilles adultes varie entre 36.5 cm et 60.4 cm. Le coefficient de broutage «A» est compris entre 11.0 et 37.6 %. L'indice foliaire global ou IF global, correspondant à la surface foliaire par faisceau pour les feuilles adultes et intermédiaires, varie entre 208.6 et 369.5 cm²/faisceau. La croissance des rhizomes, pour une même station, présente d'importantes variations interannuelles. Le maximum observé est de l'ordre de 3.5 cm, et le minimum est de 1.1 cm.

KEYWORDS: *Posidonia oceanica*, seagrass, phenology, lépidochronology, Kerkennah islands.

INTRODUCTION

Les îles Kerkennah abritent un herbier de Posidonies considéré comme l'un des mieux préservés de la Méditerranée (Burolet, 1983). Il présente des caractéristiques morphologiques très particulières (touffes semi-circulaires, atolls, aspect tigré) (Blanpied *et al.*, 1979, Burolet, 1983). Toutefois, l'herbier des îles Kerkennah reste peu étudié, malgré quelques études portant sur la répartition, la floraison ou l'état de santé de l'herbier (Le Danois, 1925 ; Molinier et Picard, 1954 ; Burolet, 1983 ; Pergent *et al.*, 1989).

Ce site possède une multitude d'atouts de nature à privilégier sa protection. De plus, la fragilité du milieu naturel est en train de s'accroître de plus en plus à travers l'exploitation des ressources, par les populations locales, devenue actuellement irrationnelle.

Dans le cadre de ce travail, une campagne d'échantillonnage a été menée durant le mois de mars 2002 en vue de caractériser l'état de l'herbier à travers une étude de la phénologie et de la lépidochronologie.

MATERIEL ET METHODES

La présente étude s'intéresse au secteur Nord Est des îles Kerkennah. Six stations, réparties sur le secteur d'étude, ont été prospectées (Fig. 1).

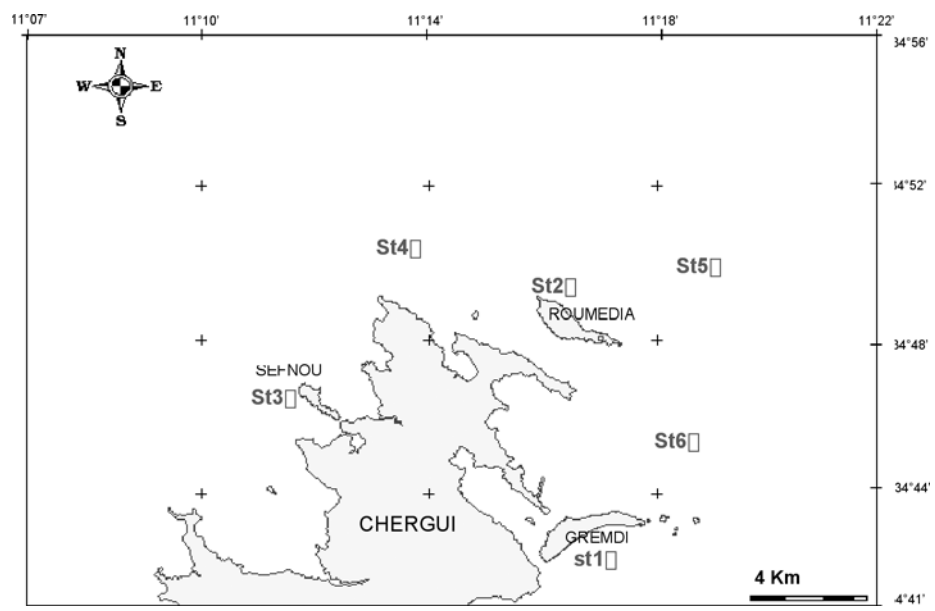

Fig. 1 : Répartition des stations d'étude

Les caractéristiques des stations figurent dans le tableau 1.

Tableau 1. Caractéristiques des stations prospectées

Stations	Profondeur (m)	Type d'herbier
1	2.0	Herbier en micro-atoll
2	1.5	Herbier en cordon
3	1.0	Herbier en cordon
4	3.2	Herbier en tâche
5	3.7	Herbier en tâche
6	3.0	Herbier en tâche

Pour l'étude de la phénologie et de la lépidochronologie, 15 faisceaux par station ont été examinés. La récolte des faisceaux a été réalisée par plongée en apnée.

RESULTATS

A- PHENOLOGIE

Les principaux résultats relatifs à l'étude phénologique sont représentés dans le tableau ci-dessous.

Tableau 2. Paramètres et indices phénologiques moyens de l'herbier de *Posidonies* au niveau des stations étudiées. NFm : Nombre moyen de feuilles par faisceau ; LTm : Longueur total moyenne des feuilles ; A : Coefficient de broutage ; IF global : Indice Foliaire global ;

St	NFm	LTm (cm)	A (%)	IF global (cm ² /faisceau)
1	6.8	54.7	23.1	362.4
2	6.2	52.4	37.6	322.7
3	5.8	60.4	34.4	369.5
4	5.3	44.6	18.2	208.6
5	5.7	36.5	11.1	212.9
6	6.2	46.1	21.2	269.9

Nombre moyen de feuilles par faisceau

Le nombre moyen de feuilles adultes par faisceau varie entre un minimum de 5.3 dans la station 4 à un maximum de 6.8 dans la station 1. La majorité des feuilles examinées sont des feuilles adultes. Le pourcentage des feuilles adultes dans les six stations prospectées varie entre 95.2 % et 100 %. Ce résultat semble indiquer que le maximum des feuilles adultes s'observe durant notre période de prélèvement.

Structure des feuilles

(i) Longueur moyenne des feuilles

La longueur moyenne des feuilles par station varie entre 36.5 cm et 60.4 cm. La longueur maximale observée est enregistrée au niveau de la station 3, soit 106.5 cm. La longueur moyenne des feuilles est similaire pour les stations superficielles 1, 2 et 3, alors qu'elle est moins importante pour les stations 4, 5 et 6 les plus profondes. Il semble donc que la longueur des feuilles diminue pour des profondeurs croissantes. La longueur des feuilles intermédiaires observées au niveau des six stations est toujours inférieure à celle des feuilles adultes. Ceci s'explique par le fait que ces feuilles n'ont pas encore achevé leur croissance. La longueur des feuilles juvéniles, inférieure à 5 cm, est comprise entre 2.5 cm et 4.0 cm.

(ii) Largeur moyenne des feuilles

La largeur des feuilles adultes, au niveau des six stations, est comprise entre 0.8 cm et 1.1 cm, alors que la moyenne varie entre 0.85 et 1.02 cm. Généralement, ce sont les feuilles les plus externes dans le faisceau ou les plus âgées qui sont généralement les plus larges dans toutes les stations. Les feuilles adultes sont plus larges que les feuilles intermédiaires. Pour ces dernières, la largeur moyenne varie entre 0.82 et 0.90 cm. Pour les feuilles juvéniles, la largeur moyenne varie entre 0.72 cm et 0.90 cm.

(iii) Longueur du pétiole

La longueur du pétiole varie avec le rang de la feuille. Elle est maximale pour les feuilles externes du faisceau, et peut atteindre 6.4 cm.

Coefficient «A»

Le coefficient «A» correspond au pourcentage des feuilles intermédiaires et adultes ayant perdues leur apex. En comparant les valeurs du coefficient A, avec celles existantes dans la littérature, on constate que l'impact des brouteurs, ou l'hydrodynamisme, dans les stations étudiées est peu important. Il semble que le coefficient A varie en fonction de la profondeur. On remarque qu'il diminue avec la profondeur croissante ce qui semble indiquer une consommation des feuilles de Posidonies plus importante dans les herbiers les plus superficiels que dans les herbiers situés plus profondément, ou traduire la réduction de l'hydrodynamisme en profondeur.

IF (Indice Foliaire) ou LAI (Leaf Area Index)

L'indice foliaire IF correspond à la surface foliaire par faisceau pour les feuilles adultes ou intermédiaires. L'indice foliaire varie en fonction des valeurs moyennes de la longueur, la largeur et du nombre des feuilles adultes et intermédiaires.

B) LEPIDOCHRONOLOGIE

L'étude des 90 rhizomes montre que:

- Le nombre moyen de feuilles produites par année varie entre 6.2 et 7.2 ;
- La croissance moyenne est comprise entre 19.7 et 22.6 mm/an ;
- La production moyenne des rhizomes est comprise entre 172 à 198 mg PS/faisceau/année.

On remarque que la croissance des rhizomes pour une même station subit d'importantes variations interannuelles. Le maximum de croissance observé est enregistré au niveau de la station 2 (34.5 mm), et le minimum, au niveau de la station 4 (11.0 mm).

CONCLUSION

Cette étude a permis d'établir un premier bilan indispensable pour mettre en place de futures investigations plus exhaustives, destinées à mieux connaître l'herbier de Posidonies du Nord Est des îles Kerkennah. En comparant nos résultats à ceux trouvés par Ramos-Espla et al. (2000) et par Ben Mustapha et Hattour (1992), on remarque qu'ils sont plus au moins semblables.

Les futures recherches scientifiques portant sur cet herbier de *Posidonies* devront mettre l'accent sur :

- la localisation et la dynamique de la limite inférieure des herbiers à *Posidonia oceanica*; ce suivi peut être basé sur la mise en place de balises (repères fixes) au contact de l'herbier il devra être réalisé en plongée.
- la vitalité de l'herbier ; elle sera estimée par des mesures in situ de densité et de recouvrement, complétées par des prélèvements de faisceaux pour l'étude phénologique et lépidochronologique sur une période d'étude plus étendue dans le temps (cycle annuel);
- la position et la structure de la limite supérieure de l'herbier grâce à la télédétection aéroportée (photographies aériennes ou satellitaire).

REFERENCES

Ben Mustapha K. & Hattour A. (1992) – Les herbiers de *Posidonies* du littoral tunisien : I : Le golfe de Hammamet. Nat. Inst. Nat. Scien. Techn. Océanogr. Pêche, Salammbô, 2 : 1-20.

Blanpied C., Burrolet P.F., Clairfond P. & Shimi M. (1979) – Sédiments actuels et holocènes. In : Géologie Méditerranéenne, la Mer pélagienne. 6(1) : 61-82.

Burollet P.F. (1983). Répartition des *posidonies* à l'Est de la Tunisie. Rapp. Comm. Int. Mer Médit., 28(3) : 173-174.

Le Danois E. (1925) – Recherches sur les fonds chalutables des côtes de Tunisie (croisière du chalutier 'Tranche' en 1924). Annls. Sta. Océanogr. Salammbô, 1 : 1-56.

Molinier R. & Picard J. (1954) – Eléments de bionomie marine sur les côtes de Tunisie. Bull. Sta. Océanogr. Salammbô, 48 : 1-47.

Pergent G., Ben Maiz N., Boudouresque C.F. & Meinesz A. (1989) – The flowering of *Posidonia oceanica* over the past fifty years: a lepidochronological study. In: Boudouresque C.F., Meinesz A., Fresi E. & Gravez V. (eds.), International Workshop on *Posidonia oceanica* Beds. GIS Posidonie Publ. 1: 57-61.

Ramos-Espla A.A., Ouergui A., Bayle J.T., Ben Mbarek N., Fernandez-Torquemada Y., Guallouz S., Khidri R., Sanchez-Lizaso J.L. & Yamaks S. (2000) – Contribution a la caractérisation des herbiers à *Posidonia oceanica* (L.) Delille aux îles Kerkennah (Est de la Tunisie, Méditerranée orientale), Actes du premier symposium Méditerranéen sur la végétation marine (Ajaccio, 3-4 octobre 2000), 1 :177-181.

MACROALGAL ASSEMBLAGES IN THE GULF OF NAPLES: SPATIAL VARIABILITY IN RELATION TO ANTHROPOGENIC DISTURBANCE

Ivan GUALA, Antonio ESPOSITO. and Maria Cristina BUIA

*Benthic Ecology Laboratory - Stazione Zoologica 'A. Dohrn' Punta S. Pietro 80077 Ischia (Naples) - ITALY
Ivan Guala guala@szn.it*

ABSTRACT

Subtidal assemblages are affected by biotic and abiotic factors which work at different spatial scales; moreover human activities can be an important source of variation in community composition.

In order to detect the macroalgal assemblages variability in relation to anthropogenic disturbance, a visual assessment of the cover of algal species was performed on sub-horizontal rocky substrates, at both 5 and 10 m depths, in 12 localities of the Gulf of Naples (Italy), for a total of 216 observations.

Important taxa in differentiating localities were identified. Among these, *Caulerpa racemosa*, recently introduced in the studied area, was one of the most important species in differentiating impacted and relatively undisturbed localities. Deep non impacted communities seem to be more vulnerable to the introduction of this alien seaweed. Its invasiveness, strictly linked to its reproductive modality, may be associated with summer anchorages of many leisure boats rather than with the environmental conditions of recipient localities.

KEY-WORDS: community diversity, anthropogenic disturbance, rocky substrate, *Caulerpa racemosa*.

INTRODUCTION

Urban development and anthropogenic activities are often the cause of disturbance on marine communities (GESAMP, 1997; Lindegarth and Hoskin, 2001). Plant assemblages may be threatened by chemical contaminants, excess nutrients, sewage discharge, reduced light penetration which can alter species composition and also limit the growth and depth distribution of plant species (Boyle, 1984; GESAMP, 1997; Middelboe and Sand-Jensen, 1998). Industrial centres, mercantile ports, power plants, touristic and fishing harbours, aquaculture facilities and, generally, densely populated urban zones, represent the most important sources of disturbance.

In recent years many authors have also indicated biological invasions as a possible threat to marine environment. Trade and transports globalisation has favoured a great increase of marine species introductions all over the world. In suitable conditions, non-native species can become invasive, playing a conspicuous role in recipient ecosystems, taking the place of native species, affecting the biodiversity (Carlton and Geller, 1993;

Williamson and Fitter, 1996; Piazzì *et al.* 2001; Boudouresque and Verlaque, 2002; Carlton, 2002). Human disturbed habitats are often thought to be more susceptible to invasions (Ribera and Boudouresque, 1995; Ruiz *et al.*, 1997; Leppäkoski *et al.*, 2002). With reference to the Mediterranean, Boudouresque and Verlaque (2002) listed 84 macroalgal species which have probably been introduced, 9 of these are considered invasive. Among them the tropical green alga *Caulerpa racemosa* (Forsskål) J. Agardh has invaded in the last decade the western side of the Mediterranean, spreading on every kind of substrate, from the surface to 60 m depth, and becoming a severe threat to algal diversity (Piazzì *et al.*, 2001). Recently, *C. racemosa* was also observed for the first time in the Gulf of Naples (Buia *et al.*, 2001).

About 2 000 000 of inhabitants live in the area of the Gulf of Naples (Italy, Southern Tyrrhenian Sea); a wide urban area and a big commercial port, with a maritime traffic volume near to 36000 vessels per year (Flagella, pers. comm.), is present in the inner side of the gulf, and several fishing and touristic harbours, and aquaculture facilities are spread all around the coast. Such high density of population and consequent anthropogenic activities are able to determine strong disturbances on marine ecosystems with possible changes in macroalgal communities.

In the framework of the ALIENS project, a survey along Neapolitan coasts was performed, during the summer 2002, with the aim to detect the distribution of *C. racemosa*, also providing a description of the recipient communities, comparing habitats with a different degree of human interference. On the basis of macroalgal composition, differences among localities placed in human disturbed areas and localities far from possible source of disturbance were described. The occurrence of *C. racemosa* in many studied localities was discussed in relation to species richness, total algal coverage and presence of main taxa.

MATERIALS AND METHODS

Study area and sampling design

In July 2002 a hierarchical survey in the Gulf of Naples (Fig. 1) was performed on subtidal rocky substrate at both 5 and 10 m depth. Sampling localities were selected on the northern and southern sides of the Gulf; the inner part was not considered because of its sandy and muddy bottoms. Six "impacted" localities (named from 1 to 6) were *a priori* selected in human disturbed areas (close to farming facilities, harbours and urban zones), six (from 7 to 12) were chosen in relatively undisturbed areas: they were considered as "controls". Each locality comprised a stretch of shoreline of about 0.2 - 1.5 Km and included three sites, 15 m long, randomly selected; at each site three random quadrats (50 x 50 cm on sub-horizontal substrate at both depths) were examined by visual estimation of the coverage of conspicuous macroalgal species (more than 2 cm in size or smaller, but forming patches occupying more than 4 square cm); species not recognised in field were collected and fixed in formal 4% to be identified in laboratory. Species richness (number of taxa) and total percent coverage were calculated for each of the studied quadrats.(Fig.1)

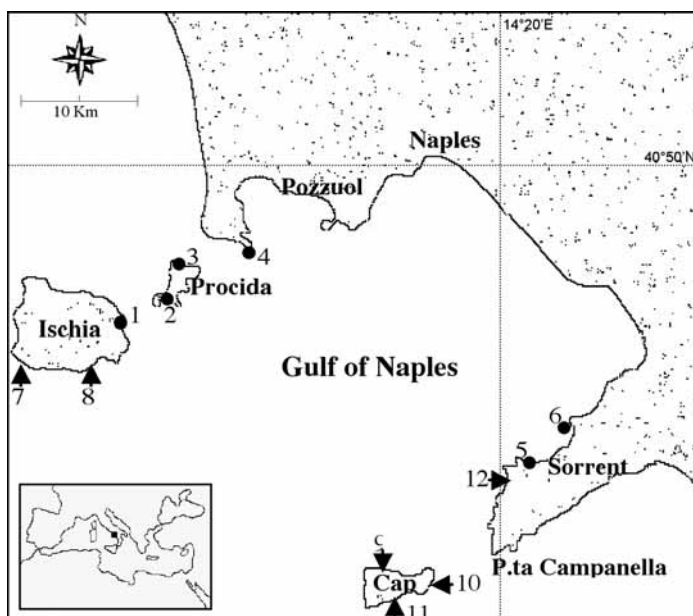

Fig. 1: Studied area and sampling localities. Dots are impacted localities (1-6) and arrows are controls (7-12).

Statistical procedures

Effects of human disturbance and depth were tested on species richness and total coverage by using 4-way analysis of variance (ANOVA): anthropogenic disturbance (impacted and control) and depth (5 and 10 m) were considered as fixed and orthogonal factors, locality (6 levels), nested in condition, and site (3 levels), nested in locality, as random. Cochran's test was used to examine *a priori* the homogeneity of variances.

Multivariate patterns of macroalgal assemblages were displayed by non-metric multidimensional scaling (nMDS); data were 4th root transformed and the similarity matrices were built with Bray-Curtis index, considering locality centroids (the mean coverage values of each taxon in the 3 sites of each locality).

Taxa contributions to dissimilarity between impacted localities and controls at both depths were assessed by PRIMER SIMPER routine (Clarke and Warwick, 2001). Pattern distribution of the invasive species *C. racemosa* was analysed by using 4-way ANOVA. A *posteriori* comparison of levels of significant factors was performed by SNK test.

RESULTS

Two-hundred and sixteen quadrats were observed and a total of 61 conspicuous taxa were identified. The number of taxa per quadrat ranged from a minimum of 3 to a maximum of 15 and the total algal coverage per quadrat varied between 40 and 100%; mean values per locality varied between 5.6 ± 2.1 and 10.8 ± 1.8 for species richness and between 71.4 ± 14.5 % and 100 ± 0.0 % for algal coverage (Fig. 2); no significant differences were found in relation to disturbance and depth, while both variables varied among localities and sites within localities (Table 1).

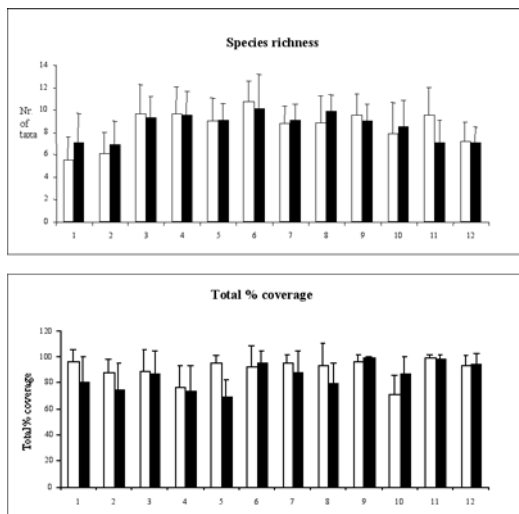

Fig. 2: Spatial patterns of species richness and total coverage ($n = 9$). White and black bars indicate respectively 5 and 10 m depth.

Table 1 : Results of ANOVA on species richness and total coverage. Di = Disturbance condition (impacted vs control), L = Locality (6 levels), S = Site (3 levels), De = Depth (5 vs 10 m); ns = not significant, * = $p < 0.05$, ** = $p < 0.01$, *** = $p < 0.001$

Source of variation	Species richness				Total coverage		
	df	MS	F	p	MS	F	p
Di	1	0.02	0.00	ns	2140.74	2.40	ns
L(Di)	10	33.20	5.33	***	891.50	2.94	*
S(DixL)	24	6.23	1.73	*	303.02	2.17	**
De	1	0.02	0.00	ns	1239.84	2.44	ns
DixDe	1	2.24	0.45	ns	1169.01	2.30	ns
DexL(Di)	10	4.93	0.73	ns	508.54	2.90	*
DexS(DixL)	24	6.78	1.89	*	175.50	1.26	ns
Res	144	3.59			139.67		
Cochran test (C)	C = 0.067	ns	C = 0.084	ns			

Non-metric MDS ordinations of locality centroids at both depths (Fig. 3) showed differences among localities ignoring the variability among sites and quadrats. Impacted localities and controls resulted well separated only at 10 m depth where controls were disjointed in two groups while the highest scattering of impacted localities pointed out the presence of more heterogeneous assemblages in this condition.

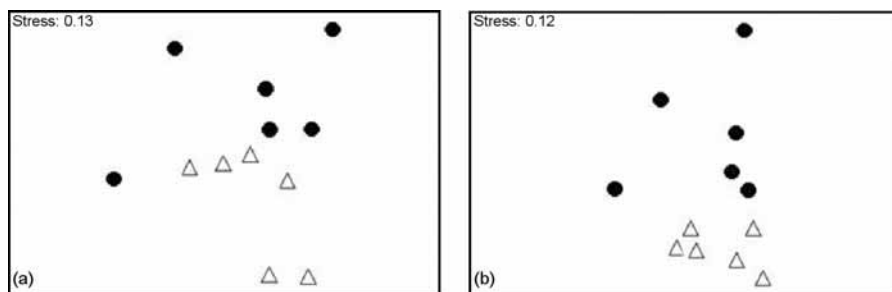

Fig. 3: MDS plots of (•) impacted locality and (Δ) control centroids at (a) 5 and (b) 10 m depth.

Taxa contributing most to dissimilarities were encrusting *Corallinaceae*, *Cladophora prolifera*, Sphacelariales and *P. pavonica* at 5 m depth and *Caulerpa racemosa*, *Dasycladus vermicularis* and encrusting *Corallinaceae* at 10 m depth.

C. racemosa was found in 9 of 12 studied localities. Its spatial distribution indicated a great heterogeneity of their abundance along the coast (Fig. 4). ANOVA, performed in spite of heterogeneity of variance ($p < 0.01$), because of the great number of freedom degree (144 in the residual) (Benedetti-Cecchi, 2003), confirmed these observations (Table 2): significant differences were observed among sites within localities. No differences were observed in relation to the disturbance conditions and depth but the interaction between these two factors showed significant differences, with highest coverage in the controls at deep stands.

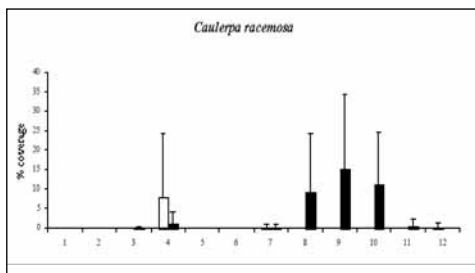

Fig. 4: Spatial patterns of coverage of *C. racemosa* ($n = 9$). White and black bars indicate respectively 5 and 10 m depth.

Table 2: Results of ANOVA on coverage of *C. racemosa*. Di = Disturbance (impacted vs control), L = Locality (6 localities), S = Site (3 sites), De = Depth (5 vs 10 m); ns = not significant, * = $p < 0.05$, ** = $p < 0.01$, *** = $p < 0.001$.

Source of variation	df	MS	F	p
Di	1	290.39	2.33	ns
L(Di)	10	124.83	1.50	ns
S(DiL)	24	83.27	2.64	***
De	1	320.84	2.76	ns
DiXDe	1	667.64	5.74	*
DexL(Di)	10	116.38	1.49	ns
DexS(DiL)	24	78.27	2.48	***
Res	144	31.54		
Cochran test (C)		C = 0.367		$p < 0.01$

Discussion

Results of this study point out a clear difference between impacted localities and controls only at 10 m depth and an overall heterogeneity of macroalgal composition of rocky subtidal beds at site level. Actually, human interference effects could be partially hidden by several natural factors not considered in this study: different types of rocky substrates (calcareous in the southern side of the gulf and volcanic in the northern one), sediment regime, light and waves exposure, current flow and moreover biotic interactions, could play substantial role in determining the community structure (Blanchard and Bourget, 1999). Synergisms of all these factors could have great influence mainly at smaller spatial scale; this is in agreement with the high variability and the patchiness distribution of macrobenthic communities recorded at site level in different locations (Fraschetti *et al.*, 2001; Ponti and Abbiati, 2003).

Moreover impacted localities were selected at intermediate and distinct levels of disturbance: three touristic harbours, two urban zones and one mussel-farm. This probably caused the higher heterogeneity of observed assemblages compared to the control ones, and it is in accordance with other studies which mark how very high disturbance implies higher homogeneity rather than intermediate level of perturbation (Fraschetti *et al.*, 2001).

With reference to *C. racemosa*, its first records in the Gulf of Naples in the late summer 1999 revealed a patchy distribution (Buia *et al.* 2001); present observations showed a relevant increase in its spreading, demonstrating the invasive behaviour of this species. Its larger occurrence in localities selected far from possible source of disturbance is not in agreement with the previous observations that human impacted areas are more

vulnerable to invaders. In reality localities selected as controls cannot be judged as pristine, because during the summer they are favourite destinations for many leisure boats which anchor innumerable. In agreement with Boudouresque *et al.*, 1995, Ceccherelli and Cinelli, 1999 and Sant *et al.*, 1996, anchorages could be the cause of the spreading and the abundance of *C. racemosa* at local scale, above all in virtue of the main reproductive modality, through vegetative fragmentation, of Caulerpales in the Mediterranean Sea.

ACKNOWLEDGEMENTS

We are grateful to Maria Monia Flagella, Mariamichela Cigliano, Raffaella Raniello, Nikos Andreakis, Bruno Iacono, Maurizio Lorenti, Gabriele Procaccini, Wiebe Kooistra, Marco Dappiano, Francesco Paolo Patti, Vincenzo Rando and Vincenzo Di Martino for their assistance during sampling activities. A special thank to Eleanor Fiore and Rosanna Messina for correcting English. This research is part of the ALIENS project funded by the European Community.

REFERENCES

- Benedetti-Cecchi L. (2003) - Disegno sperimentale ed analisi di ipotesi in ecologia. In: Gambi M.C., Dappiano M. (eds), Manuale di metodologia di campionamento e studio del benthos marino mediterraneo. Biol. Mar. Medit. 10 (Suppl.): 433-484
- Blanchard D., Bourget E. (1999) - Scales of coastal heterogeneity: influence on intertidal community structure. Mar. Ecol. Prog. Ser. 179: 163-173
- Boudouresque C.F., Verlaque M. (2002) - Biological pollution in the Mediterranean Sea: invasive versus introduced macrophyte. Mar. Poll. Bull., 44: 32-38
- Boudouresque C.F., Meinesz A., Ribera M.A., Ballesteros E. (1995) - Spread of the green alga *Caulerpa taxifolia* (Caulerpales, Chlorophyta) in the Mediterranean: Possible consequences of a major ecological event. Scientia Marina 59 (Dec) Suppl. 1:21-29
- Boyle T.P. (1984) - The effects of environmental contaminants on aquatic algae. In: Shubert L.E. (eds), Algae as ecological indicators. Academic Press Inc. (London) Ltd.: 237-256
- Buia M.C., Gambi M.C., Terlizzi A., Mazzella I. (2001) - Colonization of *Caulerpa racemosa* along the southern Italian coast: I. Distribution, phenological variability and ecological role. 352-360 pp. In: Fourth international workshop on *Caulerpa taxifolia*, Gravez V., Ruitton S., Boudouresque C.F., Le Direac'h L., Meinesz A., Scabbia G. and Verlaque M. eds., GIS Posidonie publ.
- Carlton J.T., Geller J.B. (1993) - Ecological roulette: the global transport of nonindigenous marine organisms. Science 261: 78-82
- Carlton J.T., (2002) - Bioinvasion ecology: assessing invasion impact and scale. In: E. Leppäkoski et al. (eds), Invasive Aquatic Species of Europe. 7-19. © Kluwer Academic Publishers. Printed in the Netherlands
- Ceccherelli G., Cinelli F. (1999) - The role of vegetative fragmentation in dispersal of the invasive alga *Caulerpa taxifolia* in the Mediterranean. Mar. Ecol. Prog. Ser. 182: 299-303
- Clarke K.R., Warwick R.M. (2001) - Change in marine communities: an approach to statistical analysis and interpretation, 2nd edition. PRIMER-E: Plymouth

Fraschetti S., Bianchi C.N., Terlizzi A., Fanelli G., Morri C., Boero F. (2001) - Spatial variability and human disturbance in shallow subtidal hard substrate assemblages: a regional approach. *Mar. Ecol. Prog. Ser.* 212: 1-12

GESAMP (1997) - Marine biodiversity: patterns, threats and conservation needs. *Rep. Stud. GESAMP*, (62): 24 p.

Leppäkoski E., Gollasch S., Olenin S. (2002) - Aliens species in European waters. *In: E. Leppäkoski et al.* (eds), *Invasive Aquatic Species of Europe*. 1-6. © Kluwer Academic Publishers. Printed in the Netherlands

Lindegarth M., Hoskin M. (2001) - Patterns of distribution of macro-fauna in different types of estuarine, soft-sediment habitats adjacent to urban and non-urban areas. *Estuarine, Coastal and Shelf Science*. 52: 237-247

Middelboe A.L., Sand-Jensen K. (1998) - Patterns of macroalgal species diversity in Danish estuaries. *J. Phycol.* 34: 457-466

Piazzi L., Ceccherelli G., Cinelli F. (2001) - Threat to macroalgal diversity: effects of the introduced green alga *Caulerpa racemosa* in the Mediterranean. *Mar. Ecol. Prog. Ser.* 210: 149-159

Ponti M., Abbiati M. (2003) - Variability in distribution of macrobenthos on rocky shores at Elba Island. The Sixty International Conference on the Mediterranean Coastal Environment, 7-11 October, Ravenna, Italy

Ribera M.A., Boudouresque C.F. (1995) - Introduced marine plants, with special reference to macroalgae: mechanisms and impact. *In: Round and Chapman eds., Progress in Phycological Research*, Biopress Ltd publ. 11: 187-268

Ruiz G.M., Carlton J.T., Grosholz E.D., Hines A.H. (1997) - Global invasions of marine and estuarine habitats by non-indigenous species: mechanisms, extent, and consequences. *Amer. Zool.*, 37: 621-632

Sant N., Delgado O., Rodríguez-Prieto C., Ballesteros E. (1996) - The spreading of the introduced seaweed *Caulerpa taxifolia* (Vahl) C. Agardh in the Mediterranean Sea: testing the boat transportation hypothesis. *Bot. Mar.* 39: 427-430

Williamson M., Fitter A. (1996) - The varying success of invaders. *Ecology* 77(6):1661-1666

BIOMONITORING OF ENVIRONMENTAL METALLIC CONTAMINATION

Céline LAFABRIE¹, Buno ANDRAL², Lila FERRAT¹, Vanina LEONI¹, Christine PERGENT-MARTINI¹, Didier SAUZADE²

¹ Equipe EqEL, Université de Corse, 20250 CORTE, France

² Ifremer PAC, BP 330, 83507 La Seyne st Mer Cedex - France

ABSTRACT

As part of the MONIQUA program initiated by the Corsican Territorial Collectivity, the biomonitoring of metallic contamination along the Corsican coast (Mediterranean) have been carried out using *Posidonia oceanica* (L.) Delile as bioindicator species. The analysis of mercury levels was realized in the belowground tissues (scales and rhizomes, by a lepidochronological study) on three sites: Bastia, Lumio and Macinaggio. The results show that mercury concentrations are very weak, in both tissues, for all studied sites, compared to the literature data all over the Mediterranean, nevertheless, the site of Bastia appears more contaminated than the others. This result can be explained by the level of anthropization of this site (e.g. demography). The use of a "correction factor", based on the relative theoretical contribution of scales and rhizomes weight to the belowground biomass allowed to highlight, for all sites, a significant decrease of mercury levels between 1997 and 2001.

KEY WORDS: biomonitoring / mercurial contamination / *Posidonia oceanica* / Mediterranean Sea

INTRODUCTION

The Directive Cadre on Water 2000/60/CE, forecasts the setting of the ecological and chemical state of waters and associated ecosystems monitoring. In this way, the Territorial Collectivity of Corsica initiated, in collaboration with the regions of Sardinia and Tuscany, a communal programme INTERREG (N° MCD IIIA-03/08) aiming at setting a monitoring of the waters and the marine littoral environment quality (MONIQUA). This monitoring necessity is not a recent approach and, if initially it was limited to the measure of the physico-chemical parameters and of the contaminants in the water masses and/or the sediments (e.g. Réseau National d'Observation – RNO), it is then extended to the living matter using bioindicators organisms (Claisse and Cossa, 1999) allowing a real biomonitoring. This one is based on the capacity of the bioindicator organism to concentrate in its tissues the chemical contaminants in a proportional factor to their bioavailability (Andral and Stanisière, 1999).

The interest borne to *Posidonia oceanica* (Linnaeus) Delile, in so far as a biological indicator is showed by many studies for about twenty years (Pergent, 1991). The use of this species is justified by its longevity, its benthic character, its wide geographical repartition, its capacity of concentration towards several stable pollutants (Pergent *et al.*, 1995) and its capacity to memorise the mercury, which associated to the possibilities of dating by lepidochronology, offers the possibility of a temporal follow-up of this contaminant (Pergent-Martini, 1998).

This study aims at appreciating the use of *Posidonia oceanica* for the evaluation of the actual and past environment quality.

MATERIALS AND METHODS

The study is realised in three sites of the Corsican littoral (Bastia, Lumio, Macinaggio; Fig. 1), characterized by different quality levels (Ifremer, 1994).

10 orthotropic shoots of *Posidonia oceanica* are sampled, by scuba diving, at -10 meters, in 2002, in each site. A lepidochronological analysis is realised. This technique, related to the dendrochronology, allows to date the scales (or old foliar petioles) which persist along the rhizomes (Pergent, 1990). Scales and rhizomes constitute the belowground part of the plant.



Fig. 1: Localization of the studied sites (SHOM).

At the end of the treatment, a series of rhizomes sections and the corresponding scales lots are obtained, each section/lot corresponding to a lepidochronological year (Pergent, 1990). The samples (scales and rhizomes) are frozen (-20° C), frozen-dry (>72 h) and then reduced in powder. After microwave digestion in closed vessel (Ferrat et al., 2002), the mercury is measured by flameless atomic absorption spectrometry (FIMS 100, Perkin Elmer®).

RESULTS

The measured mercury concentrations vary in function of the tissue, the year and the site.

• Influence of the tissue

A significant difference of the mercury concentrations is observed between the two studied tissues, all sites and years mingled, with higher values in the rhizomes (Kruskall Wallis, $p = 0.000056$; Table 1). This difference is also observed, all sites mingled, for the years 1998 to 2001 (ANOVA; Table 1). The concentrations in the rhizomes are here still higher than in the scales, except for 1998.

Table 1: Mercury concentration (in ng.g^{-1} of dry weight) in the scales, the rhizomes (Rhiz.) and the belowground part (Below. p.) of *Posidonia oceanica* – Lepid. year: lepidochronological year; Maci.: Macinaggio. Confidence intervals are indicated on 95% threshold.

Lepid. year	1997	1998	1999	2000	2001	Mean	
Scales	Bastia	82.6±15.0	68.9±7.5	68.1±9.7	76.4±11.6	54.5±8.1	69.7±5.2
	Lumio	58.0±12.3	51.8±5.7	59.7±16.6	42.9±4.9	44.3±5.2	51.2±4.7
	Maci.	51.0±6.4	56.8±8.3	60.4±6.9	56.4±6.1	48.3±10.7	54.6±3.6
	Mean	62.7±8.0	58.8±4.8	62.6±6.8	58.6±6.7	49.0±4.9	58.2±2.9
Rhiz.	Bastia	57.1±10.3	54.5±5.2	75.6±13.3	79.4±12.4	98.5±12.9	72.1±6.7
	Lumio	58.5±16.2	45.0±7.5	71.8±12.1	66.4±9.5	81.6±6.5	63.9±5.9
	Maci.	58.7±13.6	48.4±5.8	74.3±11.4	77.3±10.9	89.1±10.7	68.6±6.2
	Mean	58.1±7.6	49.3±3.8	73.8±6.8	73.9±6.4	90.1±6.6	68.1±3.6
Below. p.	Bastia	71.8±13.0	63.1±6.6	70.8±11.0	77.3±11.8	61.8±8.9	69.0±5.7
	Lumio	58.2±14.0	49.2±6.4	64.9±14.6	51.0±6.5	50.3±5.4	54.7±5.9
	Maci.	54.6±9.8	53.2±7.2	66.0±8.7	63.7±7.8	55.7±10.7	58.6±5.1
	Mean	61.5±10.2	55.2±8.1	67.2±3.6	64.0±14.9	55.9±6.5	60.8±4.3

Finally, for each site, the mercury concentrations, all years mingled, are higher in the rhizomes than in the scales, but this difference is significant only for the sites of Lumio and Macinaggio (ANOVA, $p = 0.0002$ and $p = 0.0001$ respectively, Fig 2). Regarding only the concentrations in the scales, all years mingled, the concentrations are significantly higher in Bastia (ANOVA, $p = 0.00001$) than in the two others sites (Fig. 2). For the rhizomes, the tendency is the same but the differences between sites are not significant (ANOVA, $p = 0.0636$; Fig. 2).

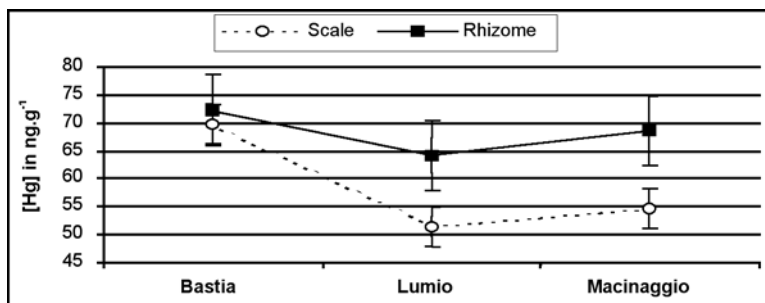

Fig. 2: Mercury concentration (in ng.g^{-1} dry weight) in scales and rhizomes of *Posidonia oceanica* in function of the site, all years mingled.

- Influence of the site

The average mercury concentration in the belowground part is determined taking into account the relative contribution of each tissue. The previously observed tendencies stay valid. All years mingled, Bastia presents the highest concentrations compared to Lumio and Macinaggio, which are little different one of the other (Table 1).

- Influence of the year

Annual differences of the mercury concentrations are recorded all sites and tissues mingled (Table 1). The 1998 year presents the weakest concentrations, whereas the maximal concentrations are observed for the year 1999.

The temporal evolution in the scales shows different tendencies for the three sites. For Bastia, a significant decrease of the mercury concentration is noted (Kruskall Wallis, $p < 0.05$) from 1997 to 1999, then from 2000 to 2001 (Table 1). For Lumio and Macinaggio, the observed variations are not significant (Kruskall Wallis, $p \geq 0.05$; ANOVA, $p \geq 0.05$), nevertheless for Macinaggio an increase of the concentrations until 1999 and a decrease since then are observed (Table 1). Conversely, the temporal evolution of mercury concentrations in the rhizomes is comparable for the three sites (ANOVA, $p \geq 0.05$), with a significant increase from 1998 to 2001 (ANOVA, $p = 0.00001$; Table 1).

DISCUSSION AND CONCLUSION

The results confirm the importance of the different factors (nature of the tissue, site and year) on the mercury contents accumulated by the marine magnoliophyta *Posidonia oceanica*. The tissue factor plays a determinant role, with higher concentrations in the rhizomes than in the scales. This preferential accumulation in the rhizomes has ever been notified by several authors (Capiomont, 2000; Maserti *et al.*, 1991). It can be due to the fact that mercurial absorption is mainly made by the root system in *Posidonia oceanica* (Ferrara and Serriti, 1989; Maserti *et al.*, 1988). It can be also due to the fact that rhizomes are living organs (Francour, 1985) which continue having a functional activity, and so accumulating trace-metals, during several years, whereas scales (dead organs) have no active accumulation (Pergent, 1987). A different accumulation (availability of the chemical forms) by the rhizomes and the foliar tissues, especially with regards to the petioles (future scales), can not be excluded, as this difference of behaviour is also observed at the level of the different sites.

So considering only the concentrations in the rhizomes, Bastia, Lumio and Macinaggio seem to behave equally. Conversely, the contents recorded in the scales individualize the site of Bastia as more contaminated than the two others sites. Consequently the factor site seems to be able to overimpose and/or to modify the behaviour of the different tissues. With regards to the literature data (Capiomont, 2000; Pergent-Martini and Pergent, 2000; Sanchiz *et al.*, 1999), the values measured in this study stay relatively weak, for the scales and the rhizomes as well as for the belowground biomass in its whole, with concentrations between 50 and 70 $\text{ng}\cdot\text{g}^{-1}$. These values can be considered as the back noise of the Mediterranean Sea.

The mercury concentrations study shows that interannual variations exist at the general level (all sites and tissues mingled), as at the level of a given tissue (Table 1). So, 2001 appears significantly weaker than the other years, if only mercury concentrations in the scales, all sites mingled, are considered (Table 1). However, it is difficult to know if this reduction of mercury concentrations in the scales is correlated to a decrease of this metal in the coastal environment or if it only reflects a passive accumulation of mercury (adsorption), during the ageing of the scales or if it illustrates mechanisms of biological dilution. Indeed, Capiomont (2000) shows that during the ageing of the scales, there is a loss of biomass of these ones and that this loss is accompanied by an increase of the mercury concentrations whereas the total quantities of mercury decrease weakly. According to this author, mercury could be consequently associated to a more refractory

fraction of the decomposition. The existence of passive fixation mechanisms on the scales in function of the time has also been showed for Iron (Pergent-Martini *et al.*, 1993), but this mechanism seems circumscribed to this element. Finally, a decrease of the mercury contents in the environment can be possible but does not seem to be confirmed with regard to what is observed for the rhizomes. Indeed, these latter show an increase of mercury concentrations, in all sites, since 1998 (Table 1). Pergent (1987) evokes the fact that the growth of the rhizome, situated at the apex, is not achieved and that it can continue during two-three years, causing consequently an increase of its biomass. Pergent-Martini (1994) shows it exists a negative correlation between the quantity of mercury memorized by the rhizomes and the size of these latter. The quantities of mercury, recorded in the rhizomes for the three last years, may be so overestimated. A correction factor, based on the «theoretical» relative contribution of scales and rhizomes to the belowground biomass, can be calculated taking into consideration the relative contribution observed in 1997 and 1998, in each sites (Fig. 3). So the theoretical mercury concentration obtained shows an important decrease between 2000 and 2001. Indeed, the correction does not integrate the fact that if the rhizome had continued to grow, it would have probably continued to accumulate mercury.

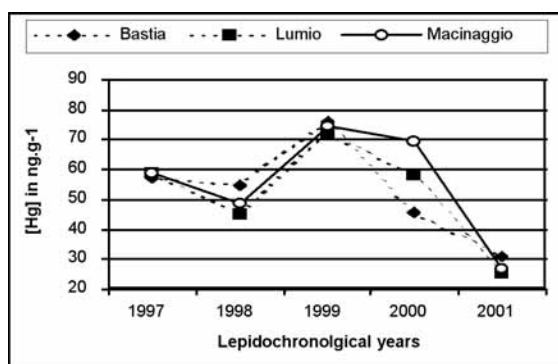

Fig 3: Corrected temporal evolution of mercury concentrations in the rhizomes of *Posidonia oceanica*, in Bastia, Lumio and Macinaggio.

Although it seems necessary improving the correctional factor to apply to the more recent years, the results obtained confirm all the interest of the use of *Posidonia oceanica* to evaluate the mercurial contamination of the coastal environment. Indeed, because of its big sensitivity, it allows establishing a gradient of quality between sites little contaminated and allows moreover to inform on the past contamination levels and to apprehend the future kinetics.

REFERENCES

Andral B., Stanisiere J.Y. (1999) - Réseau Intégrateurs Biologiques Rinbio: évaluation de la qualité des eaux basées sur l'utilisation de stations artificielles de moules en Méditerranée, résultats de la campagne 1998. Rapport détaillé Ifremer, Agence de l'eau RMC: 46 pp + Ann.

- Capiomont A. (2000) - Concentration et mémorisation du mercure chez la phanérogame marine *Posidonia oceanica*. Thèse Doct., Univ. Corse: 144 pp + Ann.
- Claisse D., Cossa D. (1999) - Historique et bilan général de la surveillance RNO dans les organismes marins. In: "RNO – 25 ans de surveillance du milieu marin", Actes de colloque Ifremer, Ifremer centre de Nantes edit, Ifremer publ: 56-62.
- Ferrara R., Seritti A. (1989) - Mercury and trace metals in waters of the western mediterranean. EROS 2000, 1 Workshop on the North-West Mediterranean Sea, Paris, 7-9 March 1989, Water Pollution Research report 13: 199-207.
- Ferrat L., Bingert A., Romeo M., Gnassia-Barelli M., Pergent-Martini C. (2002) - Mercury uptake and enzymatic response of *Posidonia oceanica* after an exposure to organic and inorganic forms. Environ. Toxicol. Chem., 21 (11): 2365-2371.
- Francour P. (1985) - Root and rhizome biomass of *Posidonia oceanica* bed. Rapp. P. V. Réunion. Comm. int. Explor. sci. Médit., 29 (5): 183-185.
- IFREMER (1994) - Qualification du littoral méditerranéen et cartographie en zones homogènes. Rapport final. Conv. Agence Eau RMC - Ifremer : 42 pp.
- Maserti B.E., Ferrara R., Morelli M. (1991) - *Posidonia oceanica*: uptake and mobilization of mercury in the Mediterranean basin. FAO/UNEP/IAEA Consultation meeting on the accumulation and transformation of chemical contaminants by biotic and abiotic processes in the marine environment, La Spezia, Italy, 24-28 Sept 1990, MAP Technical Reports, 59: 243-249.
- Maserti B.E., Ferrara R., Paterno P. (1988) - *Posidonia* as an indicator of mercury contamination. Mar. Pollut. Bull., 19 (8): 381-382.
- Pergent G. (1987) - Recherches lépidochronologiques chez *Posidonia oceanica* (Potamogetonaceae). Fluctuations des paramètres anatomiques et morphologiques des écailles des rhizomes. Thèse Doct. Océanol., Univ. Aix-Marseille II: 853 pp.
- Pergent G. (1990) - Lepidochronological analysis in the seagrass *Posidonia oceanica*: a standardized approach. Aquatic botany, 37: 39-54.
- Pergent G. (1991) - Les indicateurs écologiques de la qualité du milieu marin en Méditerranée. Oceanis, 17 (4): 341-350.
- Pergent G., Pergent-Martini C., Boudouresque C.F. (1995) - Utilisation de l'herbier à *Posidonia oceanica* comme indicateur biologique de la qualité du milieu littoral en Méditerranée: Etat des connaissances. Mésogée, 54: 3-27.
- Pergent-Martini C. (1994) - Impact d'un rejet d'eaux usées urbaines sur l'herbier à *Posidonia oceanica*, avant et après la mise en service d'une station d'épuration. Thèse Doct., Univ. Corse: 208 pp.
- Pergent-Martini C. (1998) - *Posidonia oceanica*: a biological indicator of past and present mercury contamination in the Mediterranean Sea. Mar. Environ. Res., 45 (2): 101-111.
- Pergent-Martini C., Pergent G. (2000) - Marine phanerogams as a tool in the evaluation of marine trace-metal contamination: an example from the Mediterranean. Int. J. Environment and Pollution, 13 (1-6): 126-147.
- Pergent-Martini C., Rico-Raimondino V., Pergent G., Boudouresque C.F., Bouquegneau J.M., ARNOUX A. (1993) - Mémorisation des métaux-traces par *Posidonia oceanica*. In: Boudouresque C.F., Avon M., Pergent-Martini (eds), Qualité du milieu marin - Indicateurs biologiques et physico-chimiques, GIS Posidonie publ, Marseille, 3: 105-120.
- Sanchiz C., Garcia-Carrascosa A.M., Pastor A. (1999) - Bioaccumulation of Hg, Cd and Zn in four phanerogams and the alga *Caulerpa prolifera* (Försskal) Lamouroux from the east coast of Spain. Botanica Marina, 42: 157-164.

EFFETS DE L'INCORPORATION DE L'*ULVA* sp. DANS L'ALIMENTATION DU TILAPIA DU NIL

¹ Fethi MENSI, ¹Jamel KSOURI ¹Naceur DRAIEF et Amor EI ABED

Institut National des Sciences et Technologies de la Mer (INSTM)

RÉSUMÉ

Cette étude porte sur le potentiel de la farine de l'algue *Ulva* sp. utilisé dans des aliments formulés pour des alevins du Tilapia du Nil. Les algues collectées sont lavées à l'eau douce, séchées à l'air libre, ensuite broyées. La farine d'algue présente une teneur en matière sèche de 72.08 %, en protéines de 10.67 %, en matières grasses de 0.05 %, en minéraux de 28.51% et une teneur en extrait non azoté de 32.82 %. Trois aliments isoprotéiques (30 %) ont été distribués durant 45 jours à des alevins ayant un poids moyen initial égal à 2.4 g dans un circuit ouvert dans une station aquacole du sud tunisien exploitant les eaux géothermales. Un aliment témoin ne contenant pas de la farine de l'algue *Ulva* et deux aliments en contenant 9 % et 18 % ont été formulés pour évaluer leurs effets sur le poids d'alevins de Tilapia, l'indice de conversion (IC) et l'efficacité protéique (EP). Le meilleur poids est obtenu avec l'aliment contenant 9 % de la farine d'algue. Les IC et EP sont similaires pour les différents traitements.

MOTS CLES : *Ulva*, alimentation, composition, *Tilapia*.

INTRODUCTION

L'intensification de l'élevage de *Tilapia* impliquant une dépendance grandissante en aliments concentrés, la recherche sur les besoins nutritionnels a pris deux directions, la détermination des besoins de l'animal et l'identification des matières premières intéressantes (coût bas, abondance, teneur en protéines et en énergies convenables). En Tunisie plusieurs sous-produits existent en quantités suffisantes et bon marché à savoir les pulpes de betteraves et tomates, la farine de poissons, les marcs de raisins et les fientes de volaille. De même, les algues constituent un réel potentiel d'utilisation en nutrition animale par référence à leur composition biochimique intéressante. Leur place comme complément alimentaire est toute indiquée. Selon Ksouri, (1999), les algues vertes *Chaetomorpha linum* et *Ulva* sp. ainsi que les phanérogames *Posidonia oceanica*, *Ruppia maritima* et *Cymodocea nodosa* peuvent engendrer des quantités importantes soit par leur développement dans le milieu naturel lui-même soit par leur échouage sur les rivages. La valorisation de ces sous produits permet de remplacer des quantités non négligeables des matières premières importées pour la fabrication d'aliments composés et infligant à l'économie nationale des charges financières considérables. Le Tilapia du Nil étant une espèce omnivore, son régime alimentaire dans le milieu naturel est souvent constitué d'algues, bactéries et protozoaires. Les algues vertes filamenteuses et micro algues vertes possèdent des teneurs assez importantes en protéines et énergie avec une bonne digestibilité (Manandhar, 1977 et Pampa 1982).

L'incorporation de la farine d'*Ulva* dans les aliments pour les juvéniles de la daurade (*Sparus aurata L.*) et du loup (*Dicentrachus labrax L.*) à un taux de 5 % entraîne une amélioration du poids chez les deux espèces (Wassef *et al.*, 2002a et 2002b). Au cours de cette étude, nous essayons d'étudier l'effet d'incorporation de la farine de l'*Ulva Sp.* sur les performances zootechniques du Tilapia.

MATERIEL ET METHODES

Les ingrédients utilisés dans cette étude ont été procurés du marché local; la farine de poissons provenant des usines de conservation de sardines. La farine obtenue, de qualité moyenne, contient un faible taux protéique et un taux élevé de cendre. Trois aliments iso protéiques (30 %) sont formulés, le tourteau de soja et le maïs sont remplacés par la farine de l'algue verte *Ulva sp.* à raison de 9 % (U1) et 18 % (U2). Un aliment ne contenant pas d'algue a été formulé pour servir comme témoin. Des analyses chimiques des différents ingrédients ont été faites dans le but de formuler les aliments. Matière sèche, protéines, matière grasse et minéraux sont déterminés selon les méthodes standards du O.A.C (1996). L'ENA est obtenue par différence la valeur énergétique est calculée selon Guillaume *et al.*, (1999). Les aliments sont formulés en utilisant le software excel. Le tableau 1 montre la composition chimique des différents ingrédients et la formulation des aliments.

Les algues sont collectées au cours du mois de juin à partir du lac de Ghar El Melah situé au Nord de la Tunisie. Dès leur arrivé à la station, les algues sont lavées à l'eau douce, séchées à l'air libre sur des lits de séchage. Les algues, le maïs, le tourteau de soja et la farine de poissons sont finement broyés et tamisés à l'aide d'un tamis de maille 400µm. Pour chaque formule les ingrédients sont dosés, mélangés à la main puis extrudés à travers les grilles d'un hachoir à viande (1et 3mm de diamètre). Les aliments sont pesés, ensachés et stockés dans un frigo à une température inférieure à 20°C, jusqu'à leur utilisation.

Tous les alevins ayant servi pour l'expérience ont été pesés individuellement, et répartis aléatoirement au niveau des différents traitements. Pour chaque traitement, nous avons effectué trois répétitions à raison de 100 alevins par répétition. Les poids moyens sont de 2.39, 2.40 et 2.32 g respectivement pour le lot témoin, 9 % *Ulva* (U1) et 18 % *Ulva* (U2). L'expérience a démarré le premier mai 2003 sous serre selon un système d'eau contenu et dans trois bassins chacun de 3 m de longueur, 1m de largeur et 0.70 m de profondeur. Chaque bassin est divisé en trois compartiments correspondant aux trois répétitions La séparation a été faite à l'aide des filets de mailles 500µm. Pour chaque traitement les trois lots de chaque traitement sont répartis aléatoirement au sein des bassins. Les alevins sont stockés dans les bassins, 7 jours avant le début de l'expérience pour les acclimater aux nouvelles conditions. Au cours de cette période, on a substitué les aliments habituels par les aliments expérimentaux. Le débit d'eau à l'entrée de chaque bassin étant de 0.5 l/s, permet un renouvellement d'eau de 5 fois par jour. La température de l'eau est maintenue entre 28 et 30°C grâce à un bassin tampon situé en amont de la station. Chaque jour, les bassins sont siphonnés, afin d'éliminer les déjections et les restes des aliments.

Les aliments ont été distribués manuellement trois fois par jour à raison de 20 % du poids moyen de chaque lot pour la première quinzaine et à raison de 10 % pour le reste de la période de l'expérience. Les poissons ont été pesés et comptés bimensuellement afin d'ajuster la quantité d'aliment distribuée.

Dans notre analyse statistique, les valeurs moyennes du poids des individus en élevage sont considérées pour chaque répétition comme une observation. Toutes les données recueillies ont subi une analyse de la variance selon la procédure GLM du système STATISTICA, afin de dégager les différences significatives. Le seuil de signification utilisé est 5%.

Tableau 1 : Composition chimique et formules alimentaires

Ingédient (g/kg)	Aliments			
	Témoïn	U1	U2	
Mais	330	290	250	
Tourteau de soja	520	450	420	
Farine de poisson	120	140	120	
<i>Ulva rigida</i>	-	90	180	
CMV ¹	30	30	30	
Valeurs nutritive				
Protéine (%)	30.6	30.1	29.5	
Energie (KJ/g) ²	15.3	14.5	13.8	
Composition chimique des ingrédients (%)	Mais	Tourteau de soja	Farine de poisson	Ulva Sp.
Matière sèche	86.12	85.76	90.65	72.08
Protéine	7.25	43.50	47.04	10.67
Matière grasse	0.74	0.52	0.93	0.05
Minéraux	1.28	6.50	30.23	28.51
Extrait non azoté	76.84	35.40	12.40	32.82
Energie (KJ/g)	15.22	16.6	13.64	8.19

1 Complexe miniro – vitaminique(CMV); Les vitamines et minéraux sont exprimés par kg.

VitA : 250.000UI; VitD3 : 62500UI; Vit K3 : 100mg; Vit B1 : 41mg; Vit B2 : 150mg; Calpan : 175mg; VitB6 : 90mg; Vit B12 : 0.33mg; Ac. Folique : 20mg; Biotine : 2mg; Choline : 2500UI. Fe : 1500 mg;Cu 200 mg;Mn 1750 mg; Zn : 1250 mg;I : 10 mg; Se 7.5 mg; Co : 8 mg; P : 82 mg;Ca : 240 mg; Na : 35 mg.

2 Le calcul d'énergie est basé sur les protéines : 23.7kJ/g; les matières grasses : 39.5 kJ/g et l' ENA : 17.2 kJ/g.

RESULTATS ET DISCUSSION

Comme illustré dans le tableau 2, le meilleur poids à la fin de l'expérience est celui du lot U1 qui contient 9 % d'Ulva sp. Les poids du lot, ne contenant pas d'Ulva et celui en contenant 18 % sont similaires. Selon l'analyse de la variance, la différence de poids entre ces derniers et le lot U1 est significative ($p < 0.05$). Le traitement U1 engendre la valeur la plus élevée, alors que le traitement U2 a la valeur la plus basse. L'incorporation de la farine d'Ulva entraîne une amélioration du taux de survie ($p < 0.05$). La qualité nutritionnelle des aliments formulés est similaire indépendamment de leurs compositions centésimales. En effet, il n'y a pas de différence significative en ce qui concerne le gain moyen quotidien (GMQ) et le taux de croissance spécifique (TCS).

Tableau 2 : Performances zootechniques

	Aliments Témoïn	U1	U2
Taux de survie (%)	74b	94a	92a
Poids initial (g)	2.39a	2.40a	2.32a
Poids final (g)	14.94b	16.42a	14.77a
Gain du Poids (%) ¹	525.85	583.72	537.83
Gain du Poids (g/j) ²	0.27a	0.31a	0.27a
Taux de croissance spécifique (%/j) ³	1.78a	1.84a	1.78a
Indice de conversion ⁴	2.72a	2.62a	3.12a
Efficience protéique ⁵	1.20a	1.33a	1.10a

1 Gain du Poids : $GP(\%) = 100(\text{Poids final} - \text{Poids initial}) / \text{Poids initial}$

2 Gain du Poids : $GMQ(g/j) = (\text{Poids final} - \text{Poids initial}) / (\text{Période, jours})$

3 Taux de croissance spécifique : $TCS(\%/j) = 100(\log \text{ poids final} - \log \text{ Poids initial}) / (\text{Période, jours})$

4 Indice de conversion : $IC (g/g) = \text{Quantité d'aliments ingérée} / \text{Gain moyen quotidien}$

5 Efficience protéique : $EP = \text{Gain moyen quotidien} / \text{Protéines ingérées}$

Il n'y a pas de différence significative à travers les traitements pour l'indice de conversion (IC) et l'efficience protéique (EP). A la lumière de ces résultats, la farine d'algues est utilisée efficacement par les alevins de Tilapia. Les performances obtenues restent similaires à celles des alevins nourris sur l'aliment témoin, sans farine d'Ulva sp. Il paraît que la farine d'Ulva peut être utilisée dans les aliments destinés pour des alevins de Tilapia en tant que source de protéines. Mais dans les conditions expérimentales de cette étude, il n'est pas possible de l'incorporer à des taux assez élevés. Malgré la similitude du niveau protéique des différents aliments une diminution des performances a été enregistrée. Cette diminution peut être attribuée à la source même de protéines (remplacement du tourteau par la farine d'algue). Ceci va rejoindre les conclusions tirées à partir d'autres travaux ayant essayé de remplacer le tourteau par d'autres sources protéiques ; la qualité des aliments obtenus est affectée par la présence de facteur antinutritionnel tel que l'incorporation du luzerne (Miguel *et al.*, 1990 ; Omer *et al.*, 1994). Le tourteaux de coton (Mbahinzireki, 2001) et les sous produits du transformation du coca (Jauncey, 1999). De plus, l'augmentation du niveau d'incorporation de la farine d'algue dans l'aliment s'accompagne par une diminution de la teneur en amidon et par conséquent une diminution de la valeur nutritive de l'aliment. Dans notre cas l'incorporation d'Ulva entraîne une diminution du taux d'amidon dans l'aliment. Ceci confirme les observations de Kesharanth *et al.*, (2002), qui montrent que la substitution de la farine de poisson par du maïs entraîne une amélioration des performances du carpe, il paraît que le maïs entraîne l'épargne des protéines ; ceci a été démontré chez plusieurs espèces (Cho et Kaushik, 1990 ; Shiau et Peng 1993 ; Erfanullah et Jafari 1995).

L'indice de conversion le plus élevé enregistré avec l'aliment U2 est du à la mauvaise valorisation de l'aliment par les alevins de même l'EP reflète la bonne utilisation de l'aliment ayant le faible taux protéique par rapport au témoin et U1. L'EP est amélioré avec la diminution du taux protéique (Gangadhara *et al.*, 1997).

REFERENCES

- Association of Official Analytical Chemists. (1990) - Official methods of analysis. 14th ed AOAC, Washigton, DC
- Cho C.Y., Kaushik S. J. (1990) - Nutrition energetic in fish : energy and protein utilisation in rainbow trout (*Salmo gairdeneri*).Word Rev. Nutr. Diet., 61 : 132-172.
- Erfanallaht Jafii A. K. (1995) - Growth response of fingerling Indian major carp, *Labeo rohita*(ham.) to various sources of dietary carbohydrate. J Aqua.Trop., 10 : 287-296.
- Gaugadhara B., Nandeeshha M.C., Varghese T. J., Keshavanath P. (1997) - Effect of varying protein and lipid levels on the growth of rohu, *labeo rohita*. Asian Fish. Sci., 10 : 139-149.
- Guillaume J., Kaushik S., Bergot P., Métailler R. (1999) - Nutrition et alimentation des poissons et crustacés. INRA Éditions : 485 pp
- Jauncy K., Falaye A. E. (1999) - Body composition of acceptability and digestibility by *Tilapia Oreochromis niloticus* of feeds containing coca husk. Aquaculture Nutrition, 5 : 157-161.
- Ksouri J. (2002) - Valorisation des végétaux marins par l'extraction de produits d'intérêt économique et par la culture.INSTM – Salammbou.
- Manandhar H. N. (1977) - Digestibility of phytoplankton by silver and three tilapias in polyculture with channel catfish. Master's Thesis, Auburn University, Auburn, AL.
- Mbhinzirek G. B., Dabrowski K., Lee K. J., El Saïdy D., Wisner E. R. (2001) - Growth feed utilisation and body composition of *Tilapia (Oreochromis Sp.)* Fed with cottonseeds meal – based diets in recirculating system. Aquaculture Nutrition, 7 : 189-200.
- Miguel A., Olvera-Novoa S., Campos G., Mirna Sabido G., Martinez Palacios C.A., (1990) - The use of alfalfa leaf protein concentrates as protein source in diets for *Tilapia (Oreochromis mossambicus)*. Aquaculture, 90 : 291-302.
- Pompa,T.J. (1982) - Digestibility of selected feedstuffs and naturally occurring algae by Tilapias. Ph.D.Diss., Auburn University, Auburn, AL.
- Shian S.Y., Perus C. Y. (1993) - Protein sparing effects by carbohydrates in diets for *Tilapia Oreochromis niloticus X O.aureus*. Aquaculture, 117 : 327-339.
- Lovell T. (1988) - Nutrition and feeding of fish. AVI Book, Publié par Van Nostrand Reinhold, New York.
- Wassef E. A., El – Sayed A. M., Kandeel K. M., Mansour H. A., Sakr E. M. (2000a) - The effect of feeding *Pterocladia* and *Ulva Sp.*meal in diets for Gilthead bream *Sparus aurata* L. 10th International Symposium on Nutrition and Feeding in Fish. Feeding for Quality. 2-7 June 2002. Rhodes – Greece.
- Wassef E. A., El – Sayed A. M., Kandeel K. M., Mansour H. A., Sakr E. M. (2000b) - Evaluation of two macroalgae (*Pterocladia* and *Ulva Sp.*) as dietary supplement for European Seabass *Dicentrarchus labrax* L. 10th International Symposium on Nutrition and Feeding in Fish. Feeding for Quality. 2-7 June 2002. Rhodes – Greece.

MARINE BENTHIC MACROPHYTES AS BIOINDICATORS OF EUTROPHICATION IN SELECTED EASTERN MACEDONIAN & THRACE LAGOONS, NORTH GREECE

Sotiris ORFANIDIS, Enaggelia TSIAGGA and Nikolaos STAMATIS

*Fisheries Research Institute, National Agricultural Research Foundation, 640 07 Nea Peramos, Kavala, GREECE
(sorfamid@otenet.gr)*

ABSTRACT

The marine benthic macrophytes were monitored across an eutrophication gradient of selected Macedonian & Thrace lagoons. *Ruppia cirrhosa* was the most abundant angiosperm dominated in pristine lagoons or sites within lagoon; the seaweeds *Gracilaria bursa-pastoris*, *Ulva* sp. and *Cystoseira barbata*, dominated in eutrophicated lagoons/sites. Angiosperms and seaweed coexisted at intermediate conditions. Seaweed community and key environmental parameters were more intensively monitored (2 sites x 13 months x 3 samples) in the eutrophicated lagoon Vassova. Multivariate techniques at species- and functional group-level and the Ecological Evaluation-EEI index indicated the spatio-temporal variability of water eutrophication. A cost-effective monitoring system of benthic macrophytes in lagoons could include summer destructive samplings, functional-form classification, and use of the EEI.

KEY-WORDS: monitoring, functional groups, angiosperms, seaweeds, ecological evaluation index

INTRODUCTION

Bioindicators are readily measured components of the biota that are used by managers to provide long-term ecologically relevant information about the quality (state) of ecosystem (Anderson, 1999). This approach effectively distinguishes responses of human impact from natural variability, when supported by predictive modeling and sound ecological theory. It was recently adopted by the European Union (Water Framework Directive) in order to evaluate water quality in five Ecological Status Classes (ESC) from bad to high.

Marine benthic macrophytes (seaweed and seagrasses) are key structural and functional components of some of the most productive ecosystems of the world, including lagoons. As photosynthetic sessile organisms, they respond directly to aquatic environment, and thus represent good indicators of its changes. Extensive field and laboratory experimentation have provided mechanistic explanations of their community-environment interactions.

Eutrophication is a human induced disturbance mainly caused by nitrogen and phosphorus added to water, as well as to other biological and chemical processes (de

Jonge *et al.*, 2002). Nutrient concentrations in water alone are not indicative of eutrophication status, especially in shallow ecosystems, since primary producers assimilate the nutrients very efficiently and respond non-linearly and self-accelerating when certain nutrient boundaries are crossed (Duarte, 1995). High organic content of sediment, in addition, could be toxic to marine angiosperms. Eutrophication is better indicated by its symptoms, which in the lagoons include shifts in species composition from angiosperms to the dominance of opportunistic and often bloom forming seaweeds (Harlin, 1995; Schramm and Nienhuis, 1996). This predictable successional dynamic of macrophytes is induced also by other kinds of human disturbance, e.g. bottom-trawling, overharvesting of grazers or predators and is in accordance to classical theory of r- and K-selection.

The use of benthic macrophytes as bioindicators of eutrophication and of water quality in general, several concepts, and numerical techniques (indicator taxa, diversity and biotic indices, multivariate tools) have been developed. Although composition analysis at species level is often measured, a more predictive science might be achieved by using appropriate functional classifications. They could reduce the apparent complexity of ecological systems and allow comparisons between communities with little species overlap. Furthermore, they could help to develop user-friendly protocols and cost-effective monitoring systems.

The idea of defining plant types that are in some way related to ecosystem function is not new. For seaweeds, Littler and Littler (1980) have proposed functional groups, that irrespective of phylogeny, are similar in morphology and similar in their responses to certain ecosystem functions, e.g. productivity, grazing. Orfanidis *et al.* (2001, 2003) have included seagrasses in this form-function system and then have used it to divide the benthic macrophytes in two differently responding to environmental disturbance groups, the late-successional (K-selection) and the opportunistic (r-selection). The result of this approach, which explains general macrophyte patterns across a pollution gradient mainly through their competitive abilities (Sommer and Worm, 2002), was the Ecological evaluation-EEI index.

In this study we monitored the marine benthic macrophytes across an eutrophication gradient of selected Eastern Macedonian & Thrace lagoons. The aims were (1) to select reliably interpretable signals of macrophyte responses by critically comparing different parameters of composition analysis, based at species- and functional group-level, and the biotic index EEI, (2) to suggest user-friendly protocols for a cost-effective monitoring program, e.g. WFD.

MATERIAL AND METHODS

Study area. The studied lagoons belong to the Nestos River and Vistonida estuarine system catchments (Fig. 1). They are protected by Ramsar convention and were suggested to be included in the European Natura 2000 network. Traditional fish aquaculture (mesh frames, stationary entrapment system) is the main commercial use of the lagoons. The main nutrient sources of the Nestos lagoons are agricultural run-offs

coming in from surrounding drainage channels and the old bed of the Nestos River, whereas those of the Fanari lagoon are the autumn-winter rainfalls (Orfanidis *et al.*, 2001).

Sampling: Marine benthic macrophytes were sampled between spring 1998 and summer 2001. The sampling was destructive by using a 30 cm x 50 cm x 100 cm (width x length x height) metallic stainless frame and a net (more details in Orfanidis *et al.* 2001). The site 1 (close to outlet, 0.8 m depth) and 3 (inner part, 0.4 m depth) of the Vassova lagoon (Fig. 1) were sampled monthly for seaweeds (3 random samples per site, per month), environmental parameters, and sediment from March 1998 to April 1999. Each sample was carefully sorted and identification at species- and functional group-level was attempted. The biomass of species was estimated by drying the fresh seaweed material at 60°C until constant weight.

At the middle of the water column temperature (T°C), salinity (PSU), dissolved oxygen (% saturation) and pH by using portable meters (WTW instruments) were measured. Dissolved nutrients (N-NO₃, N-NO₂, N-NH₄ and P-PO₄), chlorophyll-a (chl-a) and sediment (% organic content) were determined in the laboratory.

Data analysis: Univariate and multivariate techniques (PRIMER v. 5.0, STATGRAFICS v. 5.5) were used to describe the water and the marine benthic macrophytic community parameters. The ecological evaluation-EEI index was calculated according to Orfanidis *et al.* (2001, 2003).

RESULTS

Water parameters. Temperature (June 30.3°C, December 9.2°C) and salinity (August 26 PSU, February 34.6 PSU) followed inversely seasonal changes (Table 1). They correlated

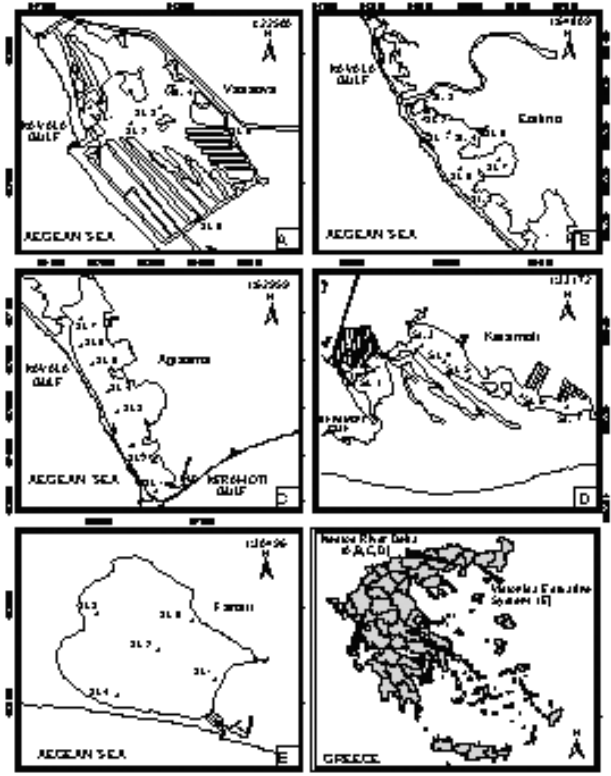

Fig. 1: A map of the studied area (St. = sampling site).

to total dissolved inorganic nitrogen (TDIN) and nitrate-N, which increased from summer (max. TDIN=6.37 $\mu\text{mol/l}$) to winter (max. TDIN=23.32 $\mu\text{mol/l}$). Phosphate-P concentrations (August 2.76 $\mu\text{mol/l}$, December 1.9 $\mu\text{mol/l}$) and pH values followed inversely seasonal changes. Dissolved oxygen (aver. 110.3 to 163.2 % saturation) and chl-a (aver. 0.13 to 0.36 $\mu\text{g/l}$) increased from the station 2 to 3.

Benthic macrophytes: Twenty-one taxa were identified in total. Three Phaeophyceae (most abundant *Cystoseira barbata*), six Chlorophyceae (most abundant *Ulva* sp. *Cladophora liniformis*, *Chaetomorpha aerea*), ten Rhodophyceae (most abundant *Gracilaria bursa-pastoris*, *Chondria tenuissima*, *Polysiphonia elongata*), and two Liliopsida (*Ruppia cirrhosa* and *Cymodocea nodosa*). They belonged into 5 functional-form groups: sheet, filamentous, coarsely branched, thick blades and seagrasses.

Table 1: Results of two-way Anova using factor scores of the PCA of water parameters (* $p < 0.05$, ** $p < 0.01$).

	df Effect	MS Effect	F
FACTOR 1 [TDIN, NO₃, S, (-T)]			
Site	1	0,28	0,85
Season	3	5,98	17,95**
Site x Season	3	0,28	0,84
Error	18	0,33	
FACTOR 2 [PO₄, (-pH)]			
Site	1	0,06	0,06
Season	3	2,96	3,36*
Site x Season	3	0,07	0,08
Error	18	0,88	
FACTOR 3 [O₂, Chl-a]			
Site	1	10,41	18,08**
Season	3	1,24	2,15
Site x Season	3	0,36	0,62
Error	18	0,58	

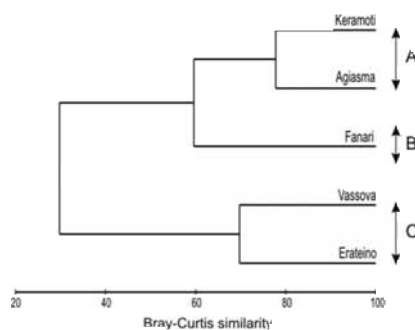

Fig. 2: Dendrogram of Bray-Curtis similarity of Eastern Macedonian & Thrace lagoons based on species composition of macrophytes.

Multivariate analysis at species-level classified the lagoons in three groups (Fig. 2, significant different at 0.1%). Simper analysis showed their characteristic species: The lagoons of group A (Agiasma, Keramoti) were dominated by *Ruppia cirrhosa*, *Cladophora liniformis* and *Gracilaria bursa-pastoris*; the lagoon of group B (Fanari) dominated by *Ruppia cirrhosa*; the lagoons of group C (Erateino, Vassova) dominated by *Cystoseira barbata*, *Gracilaria bursa-pastoris* and *Ulva* sp. A similar classification structure of the lagoons was resulted by analysing macrophytes at a functional level.

The seaweed community of the Vassova lagoon comprised sixteen taxa (3 Phaeophyceae, 4 Chlorophyceae, 9 Rhodophyceae), which belonged into 4 functional-form groups: sheet, filamentous, coarsely branched and thick blades. Total dry biomass values were changed significantly in season and station. The highest and lowest mean values were recorded in January (1276.33 g/m^2) and February (23.4 g/m^2) 1999 at site 3 and 2, respectively.

Two-way Anova of diversity indices (unit number, Shannon-Weaver, Pielou) at species- and functional group-level showed a similar trend (not shown). Multivariate analysis of the Vassova seaweed at species- and functional group-level formed one group for site 2 and two and three groups for site 3, respectively (Fig. 3).

The EEI changed seasonally in the Vassova lagoon and classified both studied sites in bad-ESC (Fig. 4). Using the EEI the studied lagoons were classified as: Vassova, Eratino and Keramoti-low ESC; Agiasma-moderate; Fanari-high.

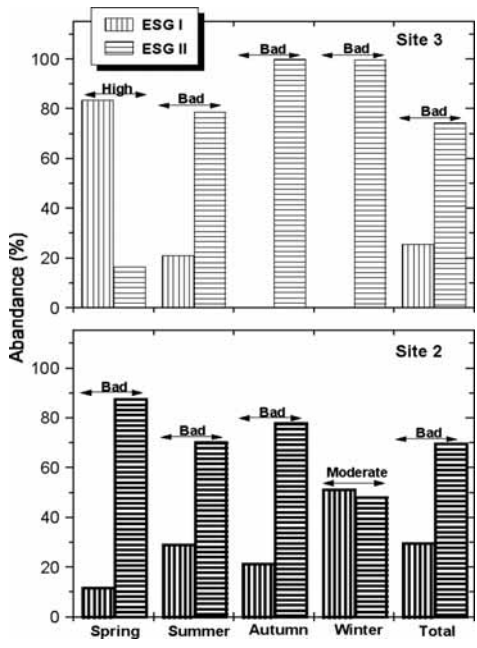
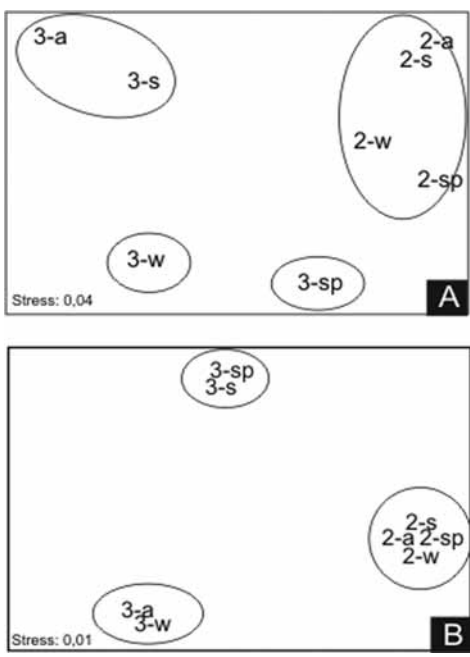

Fig. 3: MDS plot of Bray-Curtis similarity of seaweed at species (A) and functional group (B) level (w=winter, sp=spring, s=summer, a=autumn, numbers indicate site).

Fig. 4: Spatial and seasonal variability of the water quality of the Vassova lagoon based on the Ecological Evaluation index (ESG=Ecological State Group).

DISCUSSION

Taxa can be selected as bioindicators when they are abundant, functional important, sensitive to environmental changes, easily handled, but more importantly, when their responses to human impact, e.g. changes in abundance, diversity etc, can be reliably interpreted (Anderson 1999). For latter, a consensus of predictive modeling, sound ecological theory, and the perturbation pattern of the study area is needed.

Marine benthic macrophytes were dominant components of the studied lagoons benthic vegetation. The angiosperm *Ruppia cirrhosa* was dominated in the Fanari, an uniform in shape lagoon that receives, in comparison to other lagoons, the lowest agricultural run-

offs (group B; Fig. 2). The lagoons of Delta Nestos are divided in several sub-basins and receive considerable amounts of urban and agricultural run-offs from drainage channels and the old bed of the Nestos River. There, *R. cirrhosa* grew in relative restricted areas alone or in coexistence with seaweed populations (group A). In sites or lagoons where angiosperms were scarce or absent, the seaweeds species *Gracilaria bursa-pastoris*, *Ulva* sp. and *Cystoseira barbata* were dominated (group C). These results indicate the existence of a eutrophication gradient (Harlin, 1995; Schramm and Nienhuis, 1996) between two stable equilibrium states (see Scheffer *et al.*, 2001), the oligotrophic-pristine (group B) and the eutrophic-degraded (group C). The dominance of *Ruppia cirrhosa*, a late-successional angiosperm, indicates the oligotrophic state, which is characterized by low nutrient and clear water conditions. By contrast, the dominance of opportunistic seaweeds indicates the eutrophic state, which is characterized by high nutrients and turbid conditions. These conditions favor rapid growth and/or colonization ability of seaweeds to exclude angiosperms (Sommer and Worm, 2002). The absence of angiosperm could also be attributed to high organic content (>6%) of the sediment. Seaweed and angiosperm coexistence (group A) indicate intermediate conditions. A similar pattern was evident by using the EEI. The lagoon Fanari was indicated as a sustainable ecosystem and a possible reference condition lagoon for Macedonia & Thrace region (Orfanidis *et al.*, 2003). The Nestos Delta lagoons were indicated as ecosystems to be restored to a higher ESC, with only *Agiasma* to be classified as moderate and the others as low.

Water parameters in the Vassova lagoon showed a seasonal variability across a winter to summer axis (Table 1). Maximum nitrate values in winter coincided with adverse climatic and hydrographic conditions (high precipitation, strong NE to E winds and low tide) that overload the lagoon with freshwaters. Dissolved phosphorus variability indicated, beside freshwaters, also sediment as a possible P-source. The analysis of seaweed community indicated a more complex pattern (Fig. 3). Fish farming practices hinder water circulation at site 2 in winter and caused the *Ulva* bloom that self-accelerated the rest of the year. Site 3 samples were grouped mainly in a winter to summer axis due to high winter *Gracilaria* biomass. The analysis at a species-level separated spring from summer and winter, due to high growth of *Cystoseira barbata* under the clear water prevailing conditions. Noticeably, analysis at the species-level grouped autumn with summer, whereas at the functional level grouped autumn with winter. First classification is due to species of tropical affinity grew in summer and autumn, whereas the second due to seaweed responses to relative similar environmental conditions prevailing in autumn and winter.

The macrophyte community showed considerable seasonal changes. Then, the macrophyte based water quality estimations should, principally include long-term seasonal investigations. The seasonal monitoring of the Vassova lagoon showed similar water quality estimations, when summer or 4 seasonal samples were used (Fig. 4). Since summer is also the main growing season of marine angiosperms in the lagoons (Schramm and Nienhuis, 1996), one could suggest summer as an adequate sampling period in low budget monitoring programs.

CONCLUSION

Marine benthic macrophytes have been successfully used as bioindicators of eutrophication in Eastern Macedonian & Thracian lagoons. They provide readable signal with analyses based on functional group composition providing powerful support to traditional species-level analyses. Although this paper is dealing specifically with eutrophication, it is clear that the use of benthic macrophytes as bioindicators has widespread applicability in the monitoring of water quality. A cost-effective monitoring system to cover the demands of WFD could include summer destructive samplings, functional-form classification, and use of the EEI.

REFERENCES

- Anderson A. (1999) - My bioindicator or yours? Making the selection. *J. Insect Conser.*, 3: 61-64.
- De Jonge V. N., Elliott M., Orive E. (2002) - Causes, historical development, effects and future challenges of a common environmental problem: eutrophication. *Hydrobiol.*, 475/476: 1-19.
- Duarte C. M. (1995) - Submerged aquatic vegetation in relation to different nutrient regimes. *Ophelia*, 41: 87-112.
- Harlin M. M. (1995) - Changes in major plant groups following nutrient enrichment. *In*: Mc Comb A. J. (ed), *Eutrophic shallow estuaries and lagoons*, Institute for Environmental Science, Murdoch University, CRC Press, Murdoch, Australia: 173-187.
- Little M. M., Little D. S. (1980) - The evolution of thallus form and survival strategies in benthic marine macroalgae: field and laboratory tests of a functional form model. *Am. Nat.*, 116: 25-44.
- Orfanidis S., Panayotidis P., Stamatis N. (2001) - Ecological evaluation of transitional and coastal waters: a marine benthic macrophytes model. *Mar. Medit. Sc.* 2 (2): 46-65.
- Orfanidis S., Panayotidis P., Stamatis N. (2003) - An insight to the ecological evaluation index (EEI). *Ecol. Indic.*, 3: 27-33.
- Scheffer M., Carpenter S., Foley J. A., Folke C., Walker B. (2001) - Catastrophic shifts in ecosystems. *Nature*, 413: 591-596.
- Schramm W., Nienhuis P. H. (eds) (1996) - *Marine benthic vegetation: recent changes and the effects of eutrophication*. Ecological studies 123. Springer-Verlag: 470 pp.
- Sommer U., Worm B. (eds) (2002) - *Competition and coexistence*. Ecological studies 161. Springer-Verlag: 221 pp.

PHYTOBENTHOS AS QUALITY ELEMENT FOR THE EVALUATION OF THE ECOLOGICAL STATUS: A CASE STUDY OF THE IMPLEMENTATION OF THE WATER FRAME DIRECTIVE (2000/60/EC) IN THE MEDITERRANEAN ECOREGION

Panayotis PANAYOTIDIS., Barbara MONTESANTO and Sotiris ORFANIDIS

Hellenic Center for Marine Research, Institute of Oceanography, POB 712, Anavissos 19013, GREECE

ABSTRACT

A qualitative and quantitative study of macroalgae communities of three major taxonomic groups (Chlorophyceae, Phaeophyceae and Rhodophyceae) has been carried out at the upper infralittoral zone of metropolitan coastal area of Athens. The aim of the study was the estimation of the ecological status, using the Ecological Evaluation Index (EEI) an original biotic index based on phytobenthos. Samples were taken from 6 stations and a list of 60 taxa was dressed. The Diversity, Evenness and Similarity Index were calculated and compared with the EEI. Based on the calculated indexes the sampling stations were ranged in classes of ecological status from "Low" to "High", in terms of the Water Framework Directive 2000/60/EC.

KEY WORDS: Phytobenthos, Ecological Status, WFD, phytobenthos, Aegean Sea, Greece

INTRODUCTION

The phytobenthos is mentioned in the Framework Directive for the Water Policy (WFD, 2000/60/EC) as one of the three quality elements, proposed for the classification of the Ecological Status (ES) of coastal and transitional waters (the other two quality elements are zoobenthos and phytoplankton). The term "*classes of Ecological Status*" is used in the text of the WFD in order to describe the degree of human impact on the biological communities living in a water body. Five classes of quality (high, good, moderate, low and bad) are foreseen, the high class reflecting the undisturbed or "*reference*" conditions of the ecosystem (EC, 2000).

The present paper is a case study of implementation of the WFD in the Mediterranean, one of the eco-regions of the European coastline. The paper aims to demonstrate that several ecological indexes based on the composition and abundance of the hard bottom phytobenthos in the upper infralittoral zone could give good tools for the rapid assessment of the ecological quality of coastal waters.

MATERIAL AND METHODS

Six sampling stations were studied at the upper infralittoral zone on the marine front of the metropolitan area of Athens (coasts of Attika in Saronikos and S. Evoikos gulfs, Fig. 1).

Six samplings were carried out between summer 1998 and spring 2002 (August 98, March 99, June 99, June 01, September 01 and March 02) in order to monitor the marine benthic vegetation characteristics. The sampling was destructive (1 random sample from a permanent station-square 5 x 5 m per sampling period) on a quadrate 20cm x 20cm, which is considered to be the minimal sampling area in the case of the Mediterranean infralittoral communities.

Phytoplankton community structure was analyzed in terms of species number, total coverage, Shannon-Weaver diversity (H' , log2 basis) and Pielou evenness (J') indices.

The Ecological Evaluation Index (EEI) was calculated according to Orfanidis *et al.* (2001), described also on the site: www.fishri.gr (Laboratories / Marine Ecology / Water quality). The EEI is an original metric for the ecological status evaluation based on the concept of morphological and functional groups (Littler and Littler 1980; 1984). The species were divided in two Ecological State Groups (ESG):

In the ESG I were grouped the thick leathery, the articulate upright calcareous and the crustose calcareous species. Most of them are k-selected species. In the ESG II were grouped the foliose, the filamentous and the coarsely branched upright species. Most of them are r-selected species.

Each sampling station was classified in one of the five classes of ES after a simple cross-

Mean abundance (%) of ESG	>60	Bad	Low	Moderate
	>30 - 60	Low	Moderate	Good
	0 - 30	Moderate	Good	High
		0 - 30	>30 - 60	>60
		Mean abundance (%) of ESG I		

Fig. 2: Matrix for the evaluation of the ESG

The canopy layer of the vegetation was well developed at Stations 1, 4, 5 and 6, mainly due to the presence of *Cystoseira* species. Other species, e.g. *Dictyopteris membranacea*, formed a pseudo-canopy layer when they were massively present. A well-developed bushy layer, composed mainly by *Jania rubens*, *Laurencia optusa*,



Fig. 1: The study area

comparison of the coverage value of the ESG I and the ESG II on a matrix (Fig. 2). The numerical scoring system was used to express the category of ecological status as a number (Bad=2, Low=4, Moderate=6, Good=8 and High=10).

RESULTS

In total 60 taxa were identified (12 Chlorophyceae, 16 Phaeophyceae and 32 Rhodophyceae). At all the studied stations the Rhodophyceae were qualitatively dominant and the Phaeophyceae were quantitatively dominant (Table 1).

Padina pavonica and *Halopteris scoparia* species covered the open spaces. At stations 2 and 3 the bushy layer was the only important stratum of the vegetation. In these cases the species *Corallina elongata* and *Ulva rigida* were dominant

The number of species per sampling ranged from 9 (September '01 at Site 2) to 29 (March '99 at Site 5). A statistically significant increase of the total number of species was noticed from the Inner Saronikos Gulf sampling sites (Site 1, Site 2 and Site 3) towards the Outer Saronikos and S. Evoikos gulfs (Site 4, Site 5 and Site 6). Minimum and maximum species numbers were found at Site 2 and 5, respectively (Fig. 3).

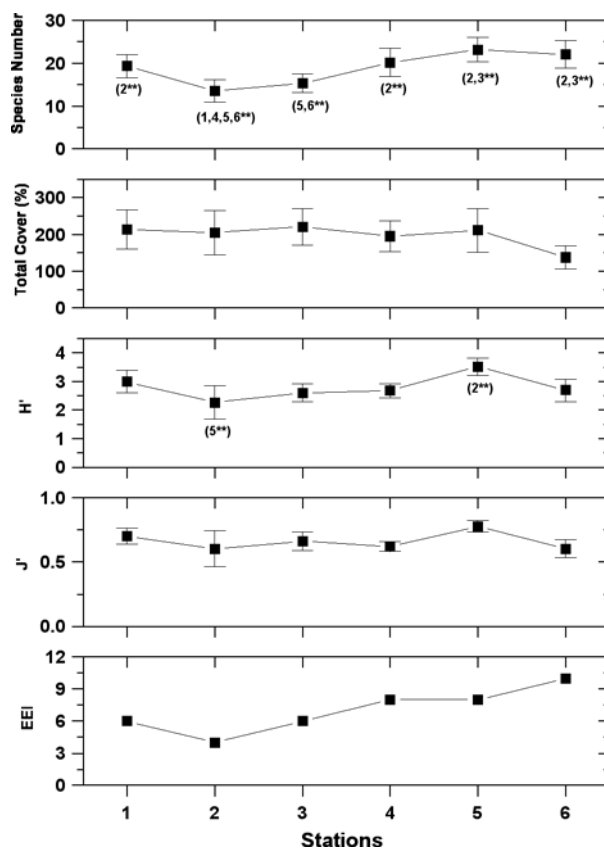

Fig. 3: Structural and functional indices variation in the studied stations. Statistical significant variations are marked with **. H'=Shannon-Weaver index, J'=Pielou evenness index, EEI=Ecological Evaluation Index.

Coverage values per sampling ranged from 90% (June '01, Site 6) to 342% (June '99, Site 5). Although there is a trend of decrease in coverage values from the Inner Saronikos towards the Outer Saronikos and S. Evoikos gulfs, no statistically significant differences among the studied sites were found.

The values of H' and J' presented a similar pattern of variation: they are decreasing from Site 1 towards Site 4, then they are increasing towards Site 5 and finally they decrease

again at Site 6. The values of H' ranged from 1.33 (August '98, Site 2) to 4.13 (March '99, Site 5) and the values of J' ranged from 0.36 (August '98, Site 2) to 0.85 (March '99, Site 5).

Table 1: List of species in the study area

Species	ESG	Site 1	Site 2	Site 3	Site 4	Site 5	Site 6
<i>Chlorophyta</i>							
<i>Acetabularia acetabulum</i>	I	-	-	-	0.2	0.8	0.8
<i>Anadyomene stellata</i>	I	-	-	-	0.3	0.8	1.0
<i>Bryopsis</i> spp.	II	0.3	-	-	-	-	0.4
<i>Caulerpa racemosa</i>	II	-	-	0.2	9.3	-	-
<i>Cladophora</i> spp.	II	2.2	0.2	9.8	3.5	4.3	5.4
<i>Codium fragile</i>	II	1.0	0.8	-	-	-	-
<i>Enteromorpha</i> spp.	II	3.3	-	-	-	-	0.4
<i>Flabellia petiolata</i>	I	-	-	-	1.2	-	1.4
<i>Halimeda tuna</i>	I	-	-	4.2	0.7	11.3	2.4
<i>Pseudochlorodesmis furcellata</i>	II	-	-	-	-	0.7	0.4
<i>Ulva rigida</i>	II	9.8	45.8	40.2	5.8	-	-
<i>Valonia utricularis</i>	II	-	-	0.3	0.2	0.8	0.2
<i>Phaeophyceae</i>							
<i>Colpomenia sinuosa</i>	II	2.7	4.3	0.8	-	-	-
<i>Cystoseira</i> cf. <i>Crinita</i>	I	59.0	-	14.3	76.8	52.4	36.3
<i>Cystoseira compressa</i>	I	9.5	-	-	15.0	8.0	35.0
<i>Cystoseira mediterranea</i>	I	-	-	-	1.7	-	-
<i>Dictyopteris membranacea</i>	II	16.5	51.8	14.7	2.7	-	2.9
<i>Dictyota</i> spp.	II	0.5	18.5	10.2	2.5	4.4	3.3
<i>Ectocarpus</i> sp.	II	-	-	-	-	-	0.4
<i>Halopteris filicina</i>	II	-	-	-	-	0.2	2.9
<i>Halopteris scoparia</i>	II	12.5	0.2	19.7	14.5	1.9	0.8
<i>Padina pavonica</i>	I	2.7	4.5	7.0	8.5	7.5	10.3
<i>Petalonia fascia</i>	II	14.5	14.7	-	-	-	-
<i>Sargassum vulgare</i>	I	22.2	4.7	12.5	15.2	6.0	-
<i>Sphacelaria cirrosa</i>	II	2.7	-	-	-	-	-
<i>Sphacelaria furcigera</i>	II	-	-	0.2	2.3	19.3	5.0
<i>Scytosiphon lomentaria</i>	II	-	-	-	-	-	0.4
<i>Taonia atomaria</i>	I	0.5	-	-	0.7	-	-
<i>Rhodophyta</i>							
<i>Acanthophora delilei</i>	II	0.5	-	22.0	-	-	-
<i>Amphirhoa rigida</i>	I	-	-	-	3.2	-	-
<i>Antithamnion</i> spp.	II	-	-	-	-	-	-
<i>Calithamnion corumbosum</i>	II	-	-	-	-	0.5	-
<i>Ceramium ciliatum</i>	II	-	-	-	0.5	-	-
<i>Ceramium diaphanum</i>	II	0.7	-	-	0.2	2.2	-
<i>Champia parvula</i>	II	-	-	-	-	1.2	-
<i>Chondria dasyphylla</i>	II	-	2.5	-	-	0.8	-
<i>Corallina elongata</i>	I	2.0	33.8	2.8	0.7	7.7	3.3
<i>Corallina granifera</i>	I	-	-	-	-	12.8	0.7
<i>Dasya rigidula</i>	II	-	-	-	-	0.7	-
<i>Dermatolithon</i> spp.	I	3.3	-	-	2.5	6.9	0.8
<i>Erithrotrichia</i> spp.	II	0.0	1.7	-	-	-	-
<i>Fosliella</i> spp.	I	1.7	-	0.3	4.2	8.0	1.3
<i>Gelidium</i> spp.	II	-	-	-	0.5	-	-

<i>Gelidiella ramellosa</i>	II	-	-	-	-	5.7	0.4
<i>Gigartina acicularis</i>	II	4.7	5.8	0.2	-	-	-
<i>Gigartina tedii</i>	II	-	2.2	-	-	-	-
<i>Gracilaria corallicola</i>	II	0.0	1.7	-	-	-	-
<i>Gonyotrichon spp.</i>	II	0.7	-	-	-	-	-
<i>Griffithsia schousboei</i>	II	0.5	0.5	-	0.2	0.3	0.8
<i>Herposiphonia secunda</i>	II	-	-	-	0.3	5.3	0.4
<i>Hypnea musciformis</i>	II	2.8	0.2	12.8	0.2	-	-
<i>Jania rubens</i>	I	28.0	2.8	36.5	19.5	20.7	12.9
<i>Laurencia obtusa</i>	II	7.7	0.5	9.8	0.7	4.3	1.3
<i>Laurencia papilosa</i>	II	-	-	-	-	-	-
<i>Lomentaria clavelosa</i>	II	0.2	-	-	0.7	9.0	1.3
<i>Lophosiphonia scopulorum</i>	II	-	2.0	-	-	-	-
<i>Lithothamnion spp.</i>	I	0.7	-	-	-	0.3	0.8
<i>Peyssonnelia rosa-marina</i>	I	-	-	-	0.5	-	4.0
<i>Polysiphonia spp.</i>	II	0.3	5.7	2.2	0.3	5.7	0.5
<i>Spermothamnion flabellatum</i>	II	-	-	-	-	0.5	-

DISCUSSION

The approach to the ecological quality status through the biotic indices is an old but still relevant development (Engle *et al.*, 1994; Grall and Glemarec 1997; Borja *et al.*, 2000) and is based on the concept of indicator groups (taxonomic or functional) of organisms. Functional was in some cases preferable than taxonomic grouping of organisms to reduce spatial and temporal community variability and to discover patterns without losing important information. For example, a universal pattern described by Regier and Cowell (1972), Murray and Littler (1978), Sousa (1980), Schramm (1999) and validated also in this study is that highly stressed or disturbed marine environments are inhabited by annual species with high growth rates and reproductive potential, while undisturbed marine environments by perennial species with low growth rates and reproductive potential. This was the spark to develop the biotic index EEI, based on the functional-morphological model of Littler and Littler (1980) and use it to divide marine benthic macrophytes in two different ecological groups, the late-successional (perennials, ESG I) and the opportunistic (annuals, ESG II).

In the case study of Attika coasts, on the basis of the EEI the sampling stations were divided into four classes of ES of increasing ES in outward direction, which is in accordance to environmental conditions in Saronikos Gulf (Simboura *et al.*, 1995). Nevertheless, the results of this study have to be validated by similar studies in other areas.

REFERENCES

- Borja A., Franco J. and Pérez V. (2000) - A marine biotic index to establish the ecological quality of soft-bottom benthos within European estuarine and coastal environments. *Mar. Poll. Bull.*, 40 (12): 1100-1114.
- EC (2000) - Council Directive for a legislative frame and actions for the water policy, 2000/60/EC, Official Journal of the E.C. 22/12/2000.
- Engle V.D., Summers J.K. and Gaston G.R. (1994) - A benthic index of environmental condition of Gulf of Mexico estuaries. *Estuaries*, 17: 372-384.
- Grall J. and Glémarec M. (1997) - Using Biotic Indices to Estimate Macrobenthic Community Perturbations in the Bay of Brest. *Estuar. coast. shelf Sci.*, 44 (Suppl. A): 43 – 53
- Littler M. M. and Littler D. S. (1980) - The evolution of thallus form and survival strategies in benthic marine macroalgae: field and laboratory tests of a functional form model. *American Naturalist*, 116: 25-44.
- Littler M. M. and Littler D. S. (1984) - Relationships between macroalgal functional form groups and substrata stability in a subtropical rocky-intertidal system. *J. exp. mar. Biol. Ecol.*, 74: 13-34.
- Orfanidis S., Panayotidis P. and Stamatis N. (2001) - Ecological evaluation of transitional and coastal waters: a marine benthic macrophytes model. *Marine Mediterranean Sciences*, 2(2): 46-65
- Regier H. A and Cowell E. B. (1972) - Applications of ecosystem theory, succession, diversity, stability, stress and conservation. *Biological Conservation*, 4 (2): 83-88.
- Schneider D. C. (1994) - Quantitative ecology: spatial and temporal scaling. Academic Press, San Diego, California.
- Schramm, W. (1999) - Factors influencing seaweed responses to eutrophication: some results from EU-project EUMAC. *J. appl. Phycol.*, 11(1): 69-78.
- Simboura N., Zenetos A., Panayotidis P. and Makra A. (1995) - Changes in benthic community structure along an environmental pollution gradient. *Mar. Poll. Bull.*, 30 (7): 470-474.
- Sousa W. P (1980) - The responses of a community to disturbance: the importance of successional age and species' life histories. *Oecologia*, 45: 72-81.

CARACTERISATION DES HERBIERS A *POSIDONIA OCEANICA* DANS LE PARC MARIN NATIONAL DE ZAKYNTHOS (GRECE)

Gérard PERGENT¹, Atef OUERGHI², Vanina PASQUALINI¹, Christine PERGENT-MARTINI¹,
Georges SKOUFAS³, Laurent SOURBES⁴ et Anastasia TSIRIKA³

¹ SEAGRASS 2000, Université de Corse, Faculté des Sciences, BP 52, 20250 Corte (France)

² CAP-ASP, Tunis (Tunisie)

³ University Thessaloniki, Thessalonik (Greece)

⁴ Zakynthos Marine National Park (Greece)

RESUME

Les herbiers à *Posidonia oceanica*, dans le Parc Marin National de Zakynthos, présentent un intérêt tout particulier vis à vis des populations de tortues marines *Caretta caretta*. Dans le cadre de l'assistance, apportée par le Centre d'Activité Régionale pour les Aires Spécialement Protégées (CAR-ASP), dans la mise en œuvre du plan d'action sur la conservation de la végétation marine en Méditerranée, une mission scientifique a eu lieu en juillet 2003 dans ce secteur. Cette mission a permis (i) d'apporter des précisions quant à la répartition des herbiers à *Posidonia oceanica*, (ii) de caractériser ces herbiers à travers leur vitalité et leur réponse aux phénomènes d'anthropisation, (iii) de mettre en place un système de surveillance basé sur le balisage de la limite inférieure, et (iv) de standardiser les informations disponibles au sein d'un Formulaire Standard des Données.

MOTS CLÉS: *Posidonia oceanica*, cartography, vitality, monitoring, Greece

INTRODUCTION

Les herbiers de phanérogames marines constituent la base de la richesse des eaux littorales dans les différentes régions de la biosphère (Green & Short, 2003). Ces herbiers jouent un rôle essentiel au niveau biologique (pôles de biodiversité, forte production primaire, oxygénation), dans le maintien des équilibres littoraux (stabilisation des fonds, réduction de l'hydrodynamisme, protection des plages) et des activités économiques concomitantes (Costanza *et al.*, 1997). En Méditerranée, ces écosystèmes sont particulièrement bien représentés avec notamment les herbiers à *Posidonia oceanica* (L.) Delile qui constituent de vastes formations entre la surface et 40 m de profondeur.

Les herbiers à *Posidonia oceanica*, dans le Parc Marin National de Zakynthos, présentent un intérêt tout particulier vis à vis des populations de tortues marines *Caretta caretta*. En effet, la baie de Laganas, l'une des principales aires de nidification pour cette espèce, est occupée par un vaste herbier qui constitue une source de nourriture indispensable (faune associée), un abri efficace lors des tempêtes (Tsirika *et al.*, 2003) et une protection des plages de pontes contre l'érosion.

Dans le cadre de l'assistance apportée par le CAR/ASP dans la mise en œuvre du plan d'action pour la conservation de la végétation marine en mer Méditerranée, adopté en

1999, une mission scientifique a eu lieu en Juillet 2003. En accord avec les gestionnaires du Parc Marin National de Zakynthos plusieurs actions ont été réalisées :

- * Cartographie des principaux peuplements et types de fonds de la baie de Laganas (optimisation du document NATURA 2000).
- * Action 2 : Caractérisation des herbiers à *Posidonia oceanica* à travers leur vitalité et leur réponse aux phénomènes d'anthropisation.
- * Action 3 : Mise en place d'un système de surveillance basée sur la position de la limite inférieure.
- * Action 4 : Mise en forme de l'ensemble des informations disponibles et intégration dans le Formulaire Standard des Données (ce dernier point fait l'objet d'un document séparé).

MATERIEL ET METHODES

Créé en Décembre 1999, le Parc Marin National de Zakynthos se situe dans la partie méridionale de l'île ; il comprend une partie marine (la baie de Laganas) et une partie terrestre (littoral adjacent) séparée du reste de l'île par une zone périphérique (Fig. 1).

La cartographie des principaux peuplements et types de fonds (sédiments meubles, substrats durs, herbier continu à *Posidonia oceanica* et mosaïque d'herbier) est réalisée à partir d'une image couleur SPOT 5 (01 septembre 2003, pixel 2.5 m), traitée à l'aide du logiciel "Multiscopé" selon la méthode développée par Pasqualini *et al.* (1997).

Les données terrains sont obtenues à partir (i) du suivi, en plongée, de la position de la limite des principaux peuplements ou types de fonds (localisation par GPS), (ii) de cartes antérieures (NATURA 2000) et (iii) de plongées ponctuelles géoréférencées. La carte obtenue est vectorisée avec le logiciel "ArcGIS 8.2". Toutes ces informations sont enregistrées dans une base de données, puis associées entre elles, afin de les organiser sous forme de couches d'informations superposables géoréférencées (Système d'Informations Géographiques).

L'herbier à *Posidonia oceanica* est caractérisé dans trois stations (Fig. 1) :

- Station REFERENCE, située au niveau de l'île de Marathonisi
- Station BITUME, située à proximité de résurgences naturelles de bitume
- Station ANTHRO, soumise à des apports d'eaux contaminés par une décharge.

Pour chaque station, une typologie précise de l'herbier et un prélèvement de 20 faisceaux orthotropes de *Posidonia oceanica* sont réalisés. Les principaux paramètres pris en compte sont la position géographique, la bathymétrie, l'aspect paysager et la densité de l'herbier à *Posidonia oceanica*. A l'issue du prélèvement les échantillons sont triés puis

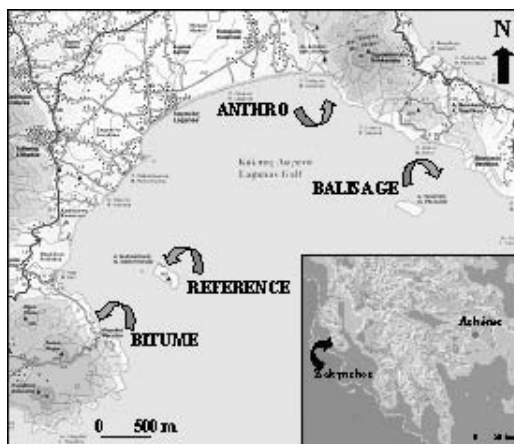

Fig. 1 : Localisation de la zone d'étude

une analyse lépidochronologique (Pergent-Martini & Pergent, 1995) et phénologique (Giraud, 1979) sont réalisées. Après avoir retiré les épiphytes, les tissus foliaires sont rincés à l'eau douce, lyophilisés puis réduits en poudre. La teneur en mercure est déterminée à l'Université de Corse, par absorption atomique sans flamme (FIMS 100®, Perkin Elmer), selon la méthode de Capiomont (2000). Pour le cobalt, le plomb et le cadmium, les échantillons sont lyophilisés puis envoyés à un laboratoire certifié.

Un système de surveillance de la position de la limite inférieure de l'herbier a été mis en place, dans la réserve intégrale à une profondeur de 25 m (Fig 1). Onze balises ont été positionnées à intervalle régulier et ancrées sur le substrat selon le protocole du Réseau de Surveillance Posidonies (Charbonnel *et al.*, 1998). Plusieurs mesures sont ensuite réalisées : (i) profondeur précise des balises, (ii) orientation les unes par rapport aux autres, (iii) typologie de l'herbier, (iv) prises de vues et (v) prélèvements de faisceaux foliaires.

RESULTATS

Le traitement des images SPOT 5 confirme la prédominance des herbiers à *Posidonia oceanica* dans la baie de Laganas (Fig. 2). Il permet d'identifier et de délimiter de manière précise les formations benthiques, notamment les mosaïques d'herbier situées entre Porto Koukla et l'île de Marathonisi. De plus, il faut noter que dans les zones

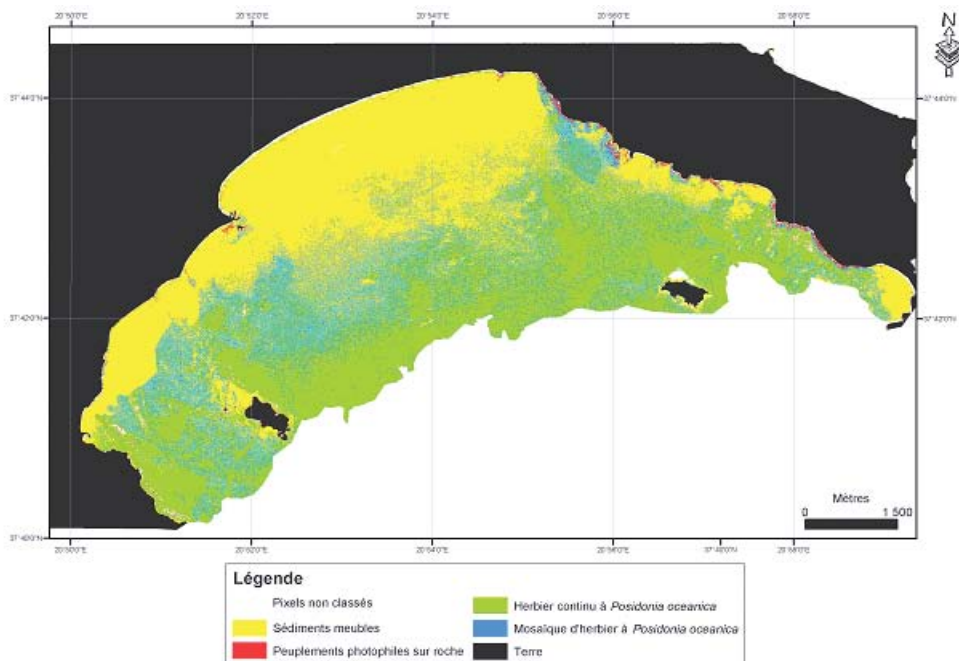

Fig. 2 : Carte thématique des principaux peuplements et types de fonds de la baie de Laganas.

relativement profondes (-10 à -20 m), au niveau de la grande plage de Laganas, il a été possible d'identifier des réponses spectrales qui pourraient correspondre, d'après les données de NATURA 2000, à des herbiers à *Cymodocea nodosa*. Ce secteur nécessiterait des investigations de terrain complémentaires

La station REFERENCE (-9.7 m) est caractérisée par un herbier à *Posidonia oceanica* sous forme de larges taches, très épiphyté; les rhizomes sont majoritairement orthotropes. La densité de l'herbier est en moyenne de 415 faisceaux par m². Les principaux paramètres phénologiques sont reportés dans le Tableau 1. Le nombre de feuilles produites est de 6.5 + 0.3 par an et la vitesse de croissance des rhizomes est de 6.7 + 0.6 mm par an. Les concentrations en métaux-traces sont faibles (Tableau 2). La station BITUME (-9.4 m) est caractérisée par un herbier continu à *Posidonia oceanica*, très épiphyté, qui prolonge une pelouse à *Cymodocea nodosa* ; il se développe en pente douce, sur sable. Les rhizomes, majoritairement orthotropes présentent un déchaussement relativement réduit. La densité de l'herbier est en moyenne 424 faisceaux par m². Les principaux paramètres phénologiques sont reportés dans le Tableau 1. Le nombre de feuilles produites est de 7.1 + 0.3 par an et la vitesse de croissance des rhizomes est de 6.5 + 0.4 mm par an. Les concentrations les plus élevées concernent le cadmium pour les bases et le cobalt pour les limbes (Tableau 2).

L'herbier à *Posidonia oceanica* de la station ANTHRO (-7.30 m) se présente sous forme de buttes témoins qui dépassent de 2 m au-dessus du sédiment sableux. Le déchaussement des rhizomes, essentiellement orthotropes, est en moyenne de 5 à 10 cm. La densité moyenne de l'herbier apparaît plus importante : 619 faisceaux par m². Les principaux paramètres phénologiques sont reportés dans le Tableau 1. Le nombre de feuilles produites est de 6.9 + 0.4 par an et la vitesse de croissance annuelle des rhizomes est de 8.9 + 1.0 mm. Les concentrations les plus élevées concernent le cadmium pour les bases et le cobalt pour les limbes (Tableau 2).

Tableau 1 : Paramètres phénologiques de l'herbier de la baie de Laganas (moyenne + IC).

Adultes et intermédiaires	REFERENCE	BITUME	ANTHRO	BALISAGE
Nombre de feuilles	5.05 + 0.33	5.45 + 0.33	3.90 + 0.42	4.25 + 0.40
Longueur totale (mm)	566.3 + 51.5	418.1 + 31.6	757.0 + 77.4	434.0 + 47.9
Longueur base (mm) (adultes)	32.4 + 2.4	29.3 + 1.4	39.4 + 2.7	31.2 + 2.4
Largeur (mm)	7.3 + 0.1	7.4 + 0.1	8.0 + 0.1	7.5 + 0.1
Coefficient A (%)	21.6 + 0.1	11.1 + 0.1	33.6 + 0.1	3.25 + 0.1
L.A.I. (cm ² /faisc.)	208.1 + 23.8	168.7 + 12.2	235.8 + 28.8	139.4 + 20.6
L.A.I. (m ² /m ²)	8.63	7.15	14.59	

Tableau 2 : Teneurs métalliques des feuilles adultes (moyenne + IC), en µg.g⁻¹ PS.

Feuilles adultes (limbe et pétiole)	REFERENCE	BITUME	ANTHRO
Cadmium	2.108 + 0.288	1.309 + 0.160	2.909 + 1.494
Cobalt	3.285 + 1.109	2.740 + 0.086	4.700 + 0.721
Mercuré	0.058 + 0.009	0.061 + 0.015	0.060 + 0.015
Plomb	2.429 + 1.036	1.227 + 0.236	1.128 + 0.245

La limite de l'herbier à *Posidonia oceanica* est une limite brusque (Meinesz & Laurent, 1978), la profondeur varie entre 24.1 et 24.7 m (Fig. 3). L'herbier en arrière de la limite est constitué de taches plus ou moins jointives, avec des intermattes bien visibles, notamment dans la première partie du balisage (balise 1 à 6). Ces touffes sont surélevées par rapport au substrat notamment au début du balisage. Cette structure n'est pas sans rappeler l'herbier de colline, tel que décrit par Boudouresque *et al.* (1985). Dans les dépressions, entre les touffes d'herbier, on note d'importantes accumulations de litière, notamment entre les balises 4, 5 et 6.

De manière générale, aucun déchaussement important des rhizomes n'a été observé le long du balisage. De même, on note la présence de rhizomes plagiotropes en bordure de touffes mais les rhizomes orthotropes restent bien représentés. Le sédiment est un sédiment sableux très fin, sans être vaseux, de couleur claire. Il est très facilement remis en suspension.

Un prélèvement de 20 faisceaux orthotropes est effectué en arrière du balisage, et une analyse phénologique est réalisée (Tableau 1).

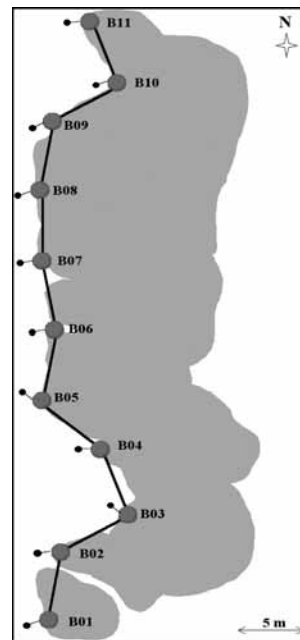

Fig. 3 : Plan du balisage

DISCUSSION ET CONCLUSION

L'utilisation des nouvelles images de SPOT 5, avec une résolution de 2.5 m, se révèle très intéressante. Ce support allie à la fois une haute résolution et une large couverture, avec des résultats performants, même pour des zones relativement profondes (supérieures à 10 m). Toutefois, il faudrait pouvoir établir un cahier des charges précis pour la réalisation de ces images, mentionnant notamment l'absence d'effets de surface (e.g conditions anticycloniques).

La densité de l'herbier, mesurée dans les trois stations étudiées correspond à des «valeurs normales» selon l'échelle de Pergent-Martini *et al.* (1999). La composition des faisceaux et leur biométrie foliaire montrent des différences significatives en fonction des stations étudiées, avec notamment des valeurs plus élevées pour la station ANTHRO. Les apports en nutriments, provenant de la décharge située à proximité de la station, pourraient être à l'origine d'un enrichissement artificiel, dans un secteur oligotrophe. De façon générale, la comparaison avec d'autres stations de Méditerranée occidentale montre une valeur plus faible de la surface foliaire des faisceaux et de la largeur des feuilles. Pour ce dernier paramètre il est possible de mettre en évidence un gradient à l'échelle du bassin qui pourrait traduire l'oligotrophie des eaux.

Bien que relativement faible, le nombre de feuilles produites annuellement est du même ordre de grandeur que celui mesuré dans d'autres secteurs de Méditerranée (Pergent-

Martini *et al.*, 1999). La vitesse de croissance des rhizomes est tout à fait comparable aux valeurs de la littérature.

L'analyse de la contamination métallique montre que le site ANTHRO présente les valeurs les plus élevées pour les teneurs en cadmium et en cobalt. Les teneurs en mercure s'avèrent comparables dans les trois sites et c'est le site REFERENCE qui montre la contamination la plus importante en plomb.

La mise en place d'un balisage de la limite inférieure de l'herbier à *Posidonia oceanica* constitue le premier élément d'un système de surveillance qui devra être développé dans l'avenir. La mise en place de deux autres balisages, le premier dans la partie centrale de la baie et le second dans la partie Ouest, serait pertinente pour suivre l'évolution globale des limites inférieures à l'échelle de la baie de Laganas. De même un retour régulier sur site, au moins tous les trois ans, est indispensable pour suivre l'extension de la limite et remettre en état les structures sous-marines.

REFERENCES

- Boudouresque C.F., Jeudy De Grissac A., Meinesz A. (1985) - Un nouveau type d'herbier à *Posidonia oceanica* : l'herbier de colline. Rapp. P.V. Réun. Commiss. internation. Explor. sci. Médit., 29(5) : 173-175.
- Capiomont A., 2000. Concentration et mémorisation du mercure chez la phanérogame marine *Posidonia oceanica*. Thèse Doctorat " Ecologie marine ", Univ. Corse : 1-144 + Ann.
- Charbonnel E., Boudouresque C.F., Meinesz A., Pergent-Martini C., San Martin G., Bertrand M.C., Foret P., Ragazzi M., Leccia M. (1998) - Le réseau de surveillance Posidonies de la région Provence-Alpes-Côte d'Azur. Première partie : Présentation et guide méthodologique. Année 1996. Région PACA/GIS Posidonie / COEL 13 / COEL 83 / Conseil Général 06 / COEL 06, GIS Posidonie publ., Marseille : 1-58.
- Costanza R., Arge R., de Groot R., Farber S., Grasso M., Hannon B., Limburg K., Naeem S., O'Neill R.V., Paruelo J., Raskin R.G., Sutton P., Van den Belt M. (1997) - The value of the world's ecosystem services and natural capital. *Nature*, 387 : 253-260.
- Giraud G. (1979) - Sur une méthode de mesure et de comptage des structures foliaires de *Posidonia oceanica* (Linnaeus) Delile. *Bull. Mus. Hist. Nat. Marseille*, 39 : 33-39.
- Green E.P., Short F.T. (2003) - *World Atlas of Seagrasses*. UNEP World Conservation Monitoring Centre, University of California Press : 1-298.
- Meinesz A., Laurent R. (1978) - Cartographie et état de la limite inférieure de l'herbier de *Posidonia oceanica* dans les Alpes-maritimes (France). Campagne Poséidon 1976. *Botanica marina*, 21(8) : 513-526.
- Pasqualini V., Pergent-Martini C., Fernandez C., Pergent G. (1997) - The use of airborne remote sensing for benthic cartography: advantages and reliability. *International Journal of Remote Sensing*, 18(5) : 1167-1177.
- Pergent G., Pergent-Martini C. (1995) - Mise en oeuvre d'un réseau de surveillance de la végétation marine en Méditerranée. *Contrat RACSPA N 10/94* : 1-44 + 37p. Annexes.
- Pergent-Martini C., Pergent G., Fernandez C., Ferrat L. (1999) - Value and use of *Posidonia oceanica* as a biological indicator. In *proceed. MEDCOAST 99 - EMECS 99 Joint Conference "Land-ocean interactions: managing coastal ecosystems"*, MEDCOAST, Middle East Technical Univ. Publ, Ankara, 1: 73-90.
- Tsirika A., G. Skoufas, S. Haritonidis. (2003) - Preliminary results on the comparative exposure to water movement in Laganas Gulf (National Marine Park of Zakynthos. 7th *Hellenic Symposium on Oceanography & Fisheries*, Hersonissos, Crète : p251

LITTORAL BENTHIC COMMUNITIES AS INDICATORS OF ENVIRONMENTAL QUALITY IN MEDITERRANEAN WATERS

Susana PINEDO, Maria GARCIA, Maria. Paola SATTÀ, Xavier TORRAS and Enric BALLESTEROS

Centre d'Estudis Avançats de Blanes. Acc. Cala Sant Francesc 14, 17300 Blanes, SPAIN

ABSTRACT

Sampling of benthic communities from the Catalonia rocky littoral (NW Mediterranean) was carried out in 1999-2000 to study the environmental quality of the waters, using the organisms as bioindicators, and DCA analysis as ordination method. Coverage of the main organisms was used as descriptors of the ecological state. *Cystoseira mediterranea* was the dominant species in the north coast, whilst the central and south coasts were mainly dominated by *Corallina elongata* and *Mytilus galloprovincialis*. Samples in reference zones (non-polluted areas, with almost nil human influence) were also introduced in the analysis to compare the water quality of the different stations in the Catalan coast with these of "pristine" areas. Our results are compared with previous data obtained in 1982. We observe changes in the structure of the littoral communities since 1982, with an apparent increase of the environmental quality. There is a decrease in the abundance of green-algae but we do not observe an increase in the abundance of *Cystoseira*. These changes can be related to the implementation of the management of the residual waters since 80's years.

KEY-WORDS: Benthic communities, bioindicators, environmental quality, littoral, Mediterranean Sea

INTRODUCTION

Benthic organisms integrate the effects of long-term exposure to natural and anthropogenic disturbances (Borowitzka, 1972). Thus, the use of benthic communities in marine pollution assessments is based on the concept that they reflect not only conditions at the time of sampling but also conditions to which the community was previously exposed. There are numerous traditional methods that identify disturbances in soft-bottom communities using macrofauna as bioindicators (e.g. Pearson and Rosenberg, 1978). For rocky benthic organisms, macrophytes are the most interesting group as integrators of the environmental quality (e.g. Levine, 1984). Studies on the effect of sewage outfalls and industrial dumping on macroalgae reveal the sensitivity of some brown algal species, mainly of the genus *Cystoseira* to pollution (e.g. Bellan-Santini, 1968; Soltan *et al.*, 2001).

Species of the genus *Cystoseira* dominate Mediterranean littoral communities (Feldmann, 1937) but they are replaced by *Corallina elongata* or *Mytilus galloprovincialis* in disturbed or polluted environments (Bellan-Santini, 1968; Ballesteros *et al.*, 1984). These two

species can also disappear when the degree of eutrophication is very high and green algae predominate (Ballesteros *et al.*, 1984). The appearance of species of blue-green algae is characteristic of very degraded environments (Golubic, 1970).

The Catalan coast can be used as an example of a heavily man-modified coast, with different sections of coast affected by different uses, from recreational to urban and industrial. In this work, benthic communities of the upper infralittoral zone were studied in 1999 and 2000 in order to (1) describe their composition; (2) establish its relationship with physical, chemical and biological variables from the water column; (3) make a comparison with data obtained with the same methodology in 1982; and (4) compare results from the catalan coast with those in pristine areas (reference zones). This study provides an observational basis for monitoring and future experimental works.

MATERIALS AND METHODS

The study was carried out in the Catalan coast (Spain, NW Mediterranean; Fig. 1). 152 and 50 stations (may-june 1999 and 2000, respectively) were sampled in the upper infralittoral zone during spring (highest development of communities).



Fig. 1: Location of study area and sites (Northwestern Mediterranean Sea). Reference zones are included in the map.

Long-term temporal changes were analyzed comparing present data with data obtained in a study carried out in 1982, using the same methodology in 89 stations along the coast (included in our 152 stations visited in 1999). In order to compare the environmental quality of the stations selected in the Catalan coast with those situated in almost pristine areas, and in the aim of implementing the Water Framework Directive, three reference zones were sampled during spring 2001 (Fig. 1): 4 samples in the coast of the Parc Naturel Régional de Corse (France), 3 samples in Formentera (Balearic Islands) and 4 samples in Menorca (Balearic Islands).

For each sample, the whole community was collected from a 15x15 cm surface, using a hammer and a chisel. One sample by site was collected in 1982 and 1999, while two replicate samples were taken in 2000. Samples were preserved in formaline sea-water at 4% and sorted in the laboratory. Algae and invertebrates were identified and quantified in terms of coverage (horizontal surface) (Ballesteros, 1992).

Detrended Correspondence Analysis (DCA) was used to show affinities and differences between samples, sites and time, using CANOCO software (ter Braak, 1988). Species appearing in less than 2% of the samples were eliminated from the analysis. The short-term temporal variability was analyzed comparing the data obtained in years 1999 and 2000, whilst data obtained in 1982 were included to look for the existence of long-term changes.

Several environmental factors were taken into account to interpret the results of the DCA (degree of exposure of the coast, type and nature of the sampled substrate, orientation of the sampled site, distance to the closest city, distance to the closest sewage outfall), as well as several chemical and biological variables of the sea-water (nitrates, nitrites, ammonium, phosphates, silicates, total and phecal coliforms and phecal streptococci) (1994-1999 average data). Pearson correlations were used to test the relationships amongst environmental and biological variables and the main axes obtained in the DCA.

RESULTS

Results from the DCA analysis for 1999 are represented in Figure 2. Both main axes explain 22,2 % of the total variance. Samples are distributed into three distinct groups. The first axis represents a gradient between samples dominated by *Cystoseira mediterranea* and samples dominated by *Ulva* spp. Samples dominated by *Mytilus galloprovincialis*, *Corallina elongata* and *Lithophyllum incrustans* are situated in an intermediate zone. The interpretation of the second axis is not so evident, although samples with *Mytilus* have the highest values of this axis, those with *Lithophyllum incrustans* have the lowest values, and *Corallina elongata* is situated in the middle.

A new DCA has been performed with samples included in the "Cystoseira" group. Two subgroups can be distinguished (Figure 3) according to the relative abundance of *Cystoseira mediterranea*, *Corallina elongata* and *Mytilus galloprovincialis*. The first group includes dense stands of *Cystoseira mediterranea*, whilst the second group includes partially degraded communities still dominated by this species, but with a significant coverage of *Corallina elongata* and *Mytilus galloprovincialis*. The first two axes explain 31.7 % of the total variance of the data (23 % and 8,7%, axis 1 and 2, respectively).

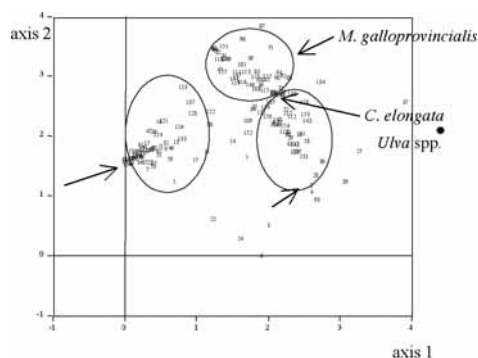

Fig. 2 : Ordination of samples and main species in the plane defined by the first two axes obtained from a DCA including the 152 samples studied in 1999.

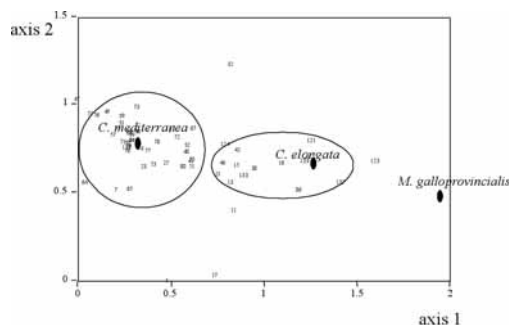

Fig. 3 : Ordination of samples and main species in the plane defined by the first two axes obtained from a DCA including only the samples of the *Cystoseira mediterranea* group displayed in Fig. 2.

Biological and chemical variables show positive and significant correlations ($p < 0.05$) with first axis for nitrites ($r = 0,316$), ammonium ($r = 0,347$), phosphates ($r = 0,301$), and phaeal streptococci ($r = 0,354$), and negative correlations ($r = -0,337$; $p < 0.05$) for the distance to the closest city. No significant relationships are observed for the second axis.

The short-term temporal variability was analyzed comparing the data obtained in 1999 and 2000. 50 stations sampled in 1999 were sampled again in 2000. The distribution of samples along the axes 1 and 2 represents 34,7 % of the variability in the data set. Our results show that the 75 % of stations did not change the species composition and the dominance of species. A high degree of coincidence between two successive assessments is observed.

The long-term temporal variability was analyzed comparing present data with data obtained in 1982. We have included also samples obtained in the reference zones in the analysis. The first two axes explain 11,9% of the total variability (Fig. 4). Most of the stations from 1982 are placed far away from the *Cystoseira mediterranea* sites, and close to the sites dominated by green algae. Therefore, the number of stations with indicators of eutrophication decreases from 1982 to 2000. Communities of *C. mediterranea* or *C. amentocea* var. *stricta* (depends on the site) are representative of the reference zones and, thus, these communities indicate the highest environmental quality.

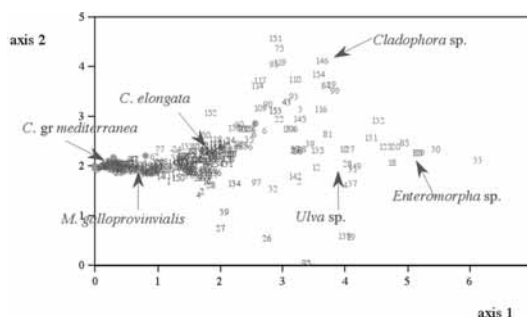

Fig. 4. Ordination of samples and main species in the plane defined by the first two axes obtained from a DCA including the samples studied in 1982 (89 stations), in 1999 (152), in 2000 (50), and in the reference zones (11). 1982 is represented in green, 1999 in blue, 2000 in red, and reference stations with orange circles.

DISCUSSION

We propose 5 categories of communities as indicators of the environmental quality of the littoral waters (high quality=category 1, and low quality=category 5): (1) Very abundant *Cystoseira mediterranea*: communities with total dominance of *C. mediterranea*. Stations grouped with values between 0 and 0,5 for the first axis in Figure 3; (2) *Cystoseira mediterranea*: other species, such as *Corallina elongata* and *Mytilus galloprovincialis*, are also present and sometimes abundant. It corresponds with the rest of stations in the Figure 3; (3) *Corallina* or *Mytilus*: communities where *Corallina elongata* and *Mytilus galloprovincialis* are the most abundant species. It corresponds with stations with values higher than 1 for axes 1 and 2 in the Figure 2; (4) *Lithophyllum* incrustans: communities with total dominance of *L. incrustans*. It corresponds with stations separated in Figure 2; and (5) Green algae: communities where *Ulva* spp., *Cladophora* spp. are the dominant.

This category includes stations situated close to the situation of these species in the Figure 2. The geographical representation of the 152 sites sampled in 1999 according to these 5 categories of environmental quality is represented in Fig. 5.

In view of these results, it can be concluded that littoral benthic communities are good indicators of environmental quality and can be used in water quality assessments. The changes in the specific composition and dominance of the communities are signs of alteration. Species with high quality environmental requirements, such as *Cystoseira mediterranea*, disappear from disturbed sites. But it is the presence of *C. mediterranea* the most indicative sign of good ecological status of littoral waters. In contrast, green algae can be considered as indicators of pollution and indicate bad ecological status. Species of the genus *Cystoseira*, being perennial plants, integrate environmental changes over a long period of time. Thus, community replacements and changes in the abundance of the main species can be used to monitor long-term changes.

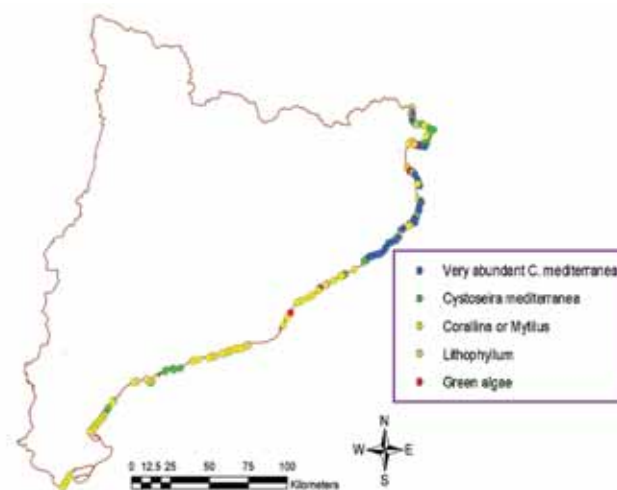

Fig 5. Geographical representation of the 152 sites sampled in 1999 according to the 5 categories of environmental quality defined in the text.

In the last 20 years it seems to be an improvement of the environmental quality along the Catalan coast as the number of stations with species indicators of eutrophication has decreased from 1982. Although there is not a recovery of *Cystoseira mediterranea*, the proliferation of green algae has decreased. This could be related to the implementation of a new system of sewage discharges from urban areas and the industry since 1980's.

In conclusion, littoral benthic communities, (1) show a geographic gradient along the catalan coast in relation to the degree of disturbance, (2) could be good indicators of the environmental quality, and (3) could be used in a monitoring program to study the water quality.

ACKNOWLEDGEMENTS

This study has been financed by the Water Catalan Agency (ACA) of the Environmental Department of the Generalitat of Catalonia.

REFERENCES

- Ballesteros E. (1992) - Els vegetals i la zonació litoral: espècies, comunitats i factors que influeixen la seva distribució. *Arxius de la Secció de Ciències Cl., Institut d'Estudis Catalans, Barcelona* : 616 pp.
- Ballesteros E., Pérez M. and Zabala M. (1984) - Aproximación al conocimiento de las comunidades algales de la zona infralitoral superior en la costa catalana. *Collect. Bot.*, 15 : 69-100.
- Bellan-Santini D. (1968) - Influence de la pollution sur les peuplements benthiques. *Rev. Intern. Oceanogr. Med.*, 10 : 27-53.
- Borowitzka M.A. (1972) - Intertidal algal species diversity and the effect of pollution. *Aust. J. Mar. Fresh. Res.*, 23 : 73-84.
- Feldmann J. (1937) - Recherches sur la végétation marine de la Méditerranée. La côte des Albères. *Rev. Algol.*, 10 : 73-254.
- Golubic S. (1970) - Effect of organic pollution on benthic communities. *Mar. Poll. Bull.*, 1: 56-57.
- Levine H.G. (1984) - The use of seaweeds for monitoring coastal waters. In: *Algae as ecological indicators*, L. E. Shubert (ed.), Academic Press, London : 189-210.
- Pearson T.H. and Rosenberg R. (1978) - Macrobenthic succession in relation to organic enrichment and pollution of the marine environment. *Ocean. Mar. Biol. Ann. Rev.*, 16 : 229-311.
- Soltan D., Verlaque M., Boudouresque C.H. and Francour P. (2001) - Changes in macroalgal communities in the vicinity of the mediterranean sewage outfall after the setting up of a treatment plant. *Mar. Poll. Bull.*, 42 : 59-70.
- Ter Braak C.J.F. (1988) - CANOCO – a FORTRAN program for canonical community ordination by (partial) (detrended) (canonical) correspondence analysis (version 2.1), T.N.O. Institute of Applied Computer Science, Wageningen.

RAPID ASSESSMENT OF THE ECOLOGICAL STATUS OF A GREEK COASTAL AREA BASED ON PHYTOBENTHOS: PRELIMINARY RESULTS.

Maria SALOMIDI, Maria Antonietta - PANCUCCI-PAPADOPOULOU, Georges-Angelos ,
HATIRIS and Panayotis PANAYOTIDIS

National Centre for Marine Research, P.O. Box 712, 19013 Anavyssos, Attica.

e-mail : msal@ncmr.gr

ABSTRACT

The need to develop rapid bio-assessment techniques for assessing the ecological quality of coastal waters is emphasized by both scientists and policy makers. In this study non-destructive sampling was performed on macrophytobenthic populations of the upper infralittoral zone at five sites in Rhodes Island (Aegean Sea, Greece), from the busy port of the town of Rhodes to a recreational beach in Ladikon bay. All sites present various forms and degrees of anthropogenic disturbance. Photographic sampling was performed and the Ecological Evaluation Index was applied on the quantified visual data to assess the ecological status (in terms of the WFD) of the study area. The first results classified the five sites in three different Ecological Status Categories, ranging from Low at the Port of Rhodes to *High* at the distant Ladikon Bay. All intermediate stations were classified as *Good*. Further studies in terms of seasonality are necessary in order to confirm these results.

KEY WORDS: phytobenthos, ecological evaluation, rapid assessment, visual sampling

INTRODUCTION

Developing rapid bio-assessment techniques is becoming a major common goal in the field of marine ecology for several scientific and management purposes (Salomidi, 2003). Furthermore, the European Water Policy, as expressed in the *Water Framework Directive* (EEC, 2000), is prompting for an immediate quality classification of all European coastal waters. In this concept, we present here the appliance of a newly introduced Ecological Evaluation Index on marine macrophytobenthic photographic samples. Although the EEI is already known to apply well on tangible data (Orfanidis *et al.*, 2001), this is one of the first attempts to test whether its combination with a visual sampling method could provide us with a rapid assessment tool.

MATERIALS AND METHODS

Visual sampling

Sampling was performed by free diving on the upper infralittoral zone (0-50 cm). This zone is shown to respond well to the various anthropogenic impacts as it is directly subjected to pressures related to coastal activities. Moreover, the requirement of SCUBA

diving at deeper depths would decrease the method's cost-effectiveness ratio (Pagola-Carte *et al.*, 2002). Photographic sampling was performed on photophilous phyto-benthic populations in May 2003 by a NIKONOS V camera with a Morris Aqua F-III TTL Flash System. Ten photoquadrats (40X80cm) were sampled for each site, the first one being randomly selected while the other nine following at equal distances.

At lab, a transparent grid divided in 100 equal squares was overlapped on each photosample to calculate percentage coverage values for all conspicuous species. Where identification down to species level was not possible, organisms were aggregated into groups of similar morphological and functional characteristics (see Terlizzi *et al.*, 2002), thus un-affecting the Ecological Evaluation Index.

Ecological Evaluation Index

The Ecological Evaluation Index (EEI) was applied on the quantified data. The Index is based on the functional diversity of macrophyto-benthic populations.

Species were classified into two *Ecological State Groups*, namely:

- ESG I comprising the *late successional species*, that is species with thick or calcareous thallus, low growth rates and long life cycles (mostly *K-selected species*).
- ESG II comprising the opportunistic species, sheet-like and filamentous organisms, with high growth rates and short life cycles (mostly *r-selected species*)

Mean absolute coverage values of ESGI and ESGII were then cross compared in an *ad hoc* modulated matrix (Fig. 1) to result in one of the five WFD Status Categories (High, Good, Moderate, Low or Bad).

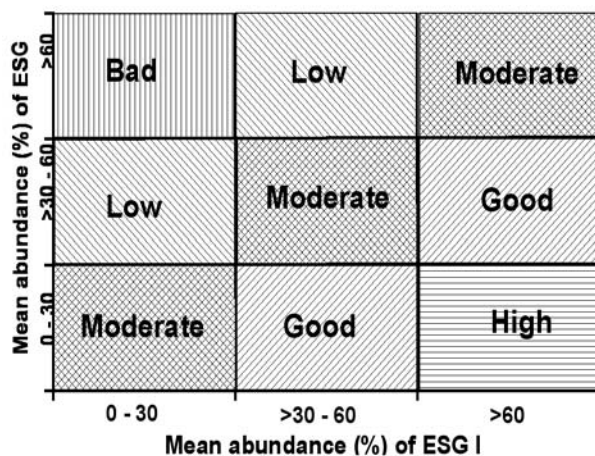

Figure 1: Matrix based on mean abundances of ESGI and ESGII to determine the ecological status of a coastal area (from Orfanidis *et al.*, 2001)

For a thorough presentation of the EEI see Orfanidis *et al.* (2001; 2003).

Study Area

The method was applied on the northeastern coasts of Rhodes Island (Aegean Sea, Greece) (Fig. 2), in order to establish whether and how it responds to certain anthropogenic impacts. The study area extends from the busy town of Rhodes (R3, town port) to a distant recreational beach in Ladikon bay (R8). All five sampling sites are situated along a well-known pollution gradient resulting from port, domestic and other coastal activities in the area.

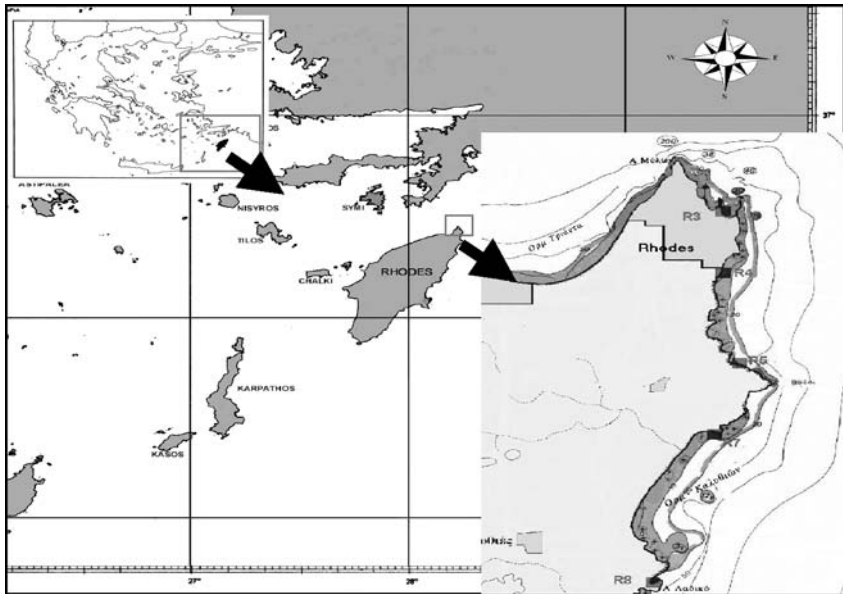

Fig. 2 : Study area in NE Rhodes Island and sampling sites.

RESULTS

Percentage coverage values for all identified species (or species groups) were calculated. Checklist and coverage values for all taxa at each station are illustrated in Table 1. *Dictyota dichotoma* and *Dictyota linearis* were the dominant species at station R3 while *Cystoseira* and *Jania* spp. dominated throughout the rest of the study area.

Table 1: Checklist, mean coverage (x %), frequency (f) and total ESG I & ESG II coverage values.

Species	ESG	R3		R4		R5		R7		R8	
		Port x%	f/10	Karakonero x%	f/10	Vodi x%	f/10	Faliraki x%	f/10	Ladiko x%	f/10
Chlorophyceae											
<i>Caulerpa racemosa</i>	II	5	8	6,4	7	1,8	5	0,9	5	4,4	7
<i>Dasycladus sp.</i>	II			0,5	1	1,7	6	1,7	5		
<i>Ulva sp.</i>	I	1	1								
<i>Flabellia petiolata</i>	I			0,8	3						
<i>Halimeda tuna</i>	I			1,7	3						
Filamentous Green Algae (Caulerpales, <i>Cladophora spp.</i>)	II	9	9	0,5	1			0,5	1	0,5	2
Phaeophyceae											
<i>Cystoseira spp.</i>	I	1	4	15,6	10	23,7	10	23,6	10	57,6	10
<i>Dictyota spp. (dichotoma & linearis)</i>	II	39	8	22	6	22,8	10	11,2	7	4,6	5
<i>Dictyota (cf. pardalis)</i>	II	7	3								
<i>Dictyopteris membranacea</i>	II	1	3	1,2	4	4,3	4	9,5	3	6,1	3
<i>Padina pavonica</i>	I	5	5	1,5	6	0,5	5	3,1	3	4,6	5
<i>Sargassum sp.</i>	I	2	4	0,9	6	4,9	9	1,1	4	2,2	4
Sphaecelariales (cf. <i>Halopteris</i>)	II	6	4	1,1	4			3,0	3	6,2	4
<i>Taonia sp.</i>	I	10	8	0,5	1			3,0	2	10,0	8
Rhodophyceae											
<i>Amphiroa rigida</i>	I	5,3	8	1,7	6	2,4	7	3,2	7	3,8	7
<i>Asparagopsis armata</i>	II	1	2								
<i>Corallina sp.</i>	I	5	10	1,5	2	2,4	4	1,2	2	0,9	2
<i>Jania spp.</i>	I	7	9	33,7	10	17,5	10	30,2	10	7,4	9
<i>Laurencia spp.</i>	II	1	1	5,1	7	9,5	10	8,4	6	0,5	1
<i>Peyssonnelia sp.</i>	I	1	1	0,5	1	0,5	2				
<i>Rhodomelaeca (cf. Chondria)</i>	II			5,2	6	4,5	4	4,1	4		
Filamentous Red Algae (cf. <i>Ceramium</i>)	II	1	8								
Filamentous Red Algae (cf. <i>Polysiphonia</i>)	II	1	8								
Encrusting Red Algae (cf. <i>Lithothamnion</i>)	I	2	9	5,9	6	12,3	8	4,0	6	0,5	1
Total ESG I coverage		37		64		64		69		87	
Total ESG II coverage		72		42		45		39		22	
Ecological Status		low		good		good		good		high	

Authors in previous studies noticed a considerable decrease in Chlorophyceae combined with an increase in Phaeophyceae as the distance from the town increased (Diannelidis *et al.*, 1977; Tsekos & Haritonidis, 1974). This trend has also been made clear by the analysis of the visual data in the present study (Fig.3).

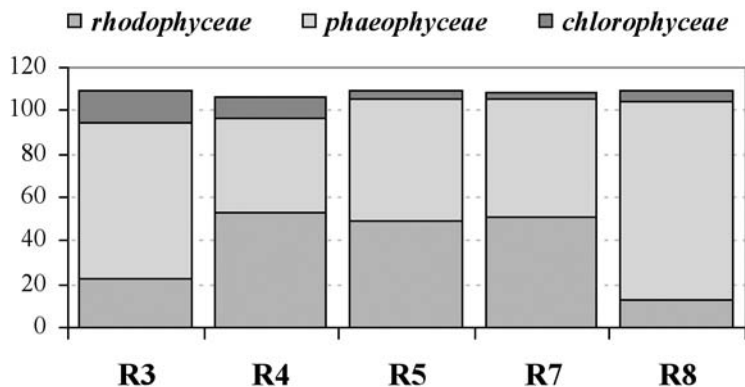

Fig. 3 : Dominance of the main systematic groups for each station. A considerable decrease in Chlorophyceae is obvious as distance from the town of Rhodes (Stations 3 and 4) increases.

The Ecological Evaluation of the area resulted in three different quality classes: *low* for the station in Rhodes port (R3), *high* for the recreational Ladikon bay (R8) and good for all intermediate stations (R4, R5 and R7) as shown in Fig. 4.

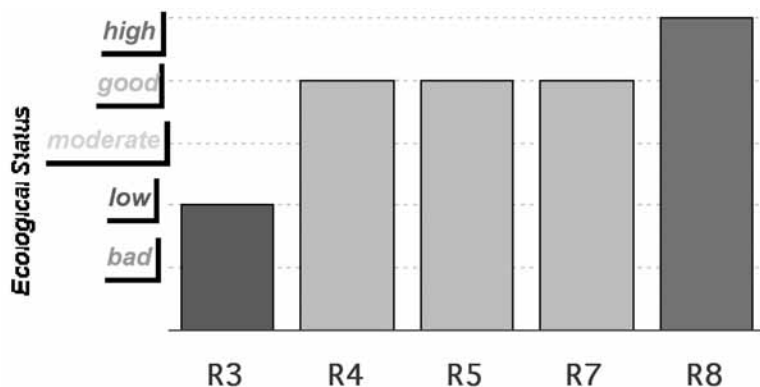

Fig. 4: Ecological Evaluation of sampling locations by the appliance of the EEI on visual phytobenthic data.

Similar results derived by the appliance of the EEI on phytobenthic data found in the literature (Diannelidis *et al.*, 1977). In spite of the fact that these data were collected by the conventional destructive method, a similar classification was observed ranging from *low* at stations near town to *good* at stations in Kallithea bay (R7 in this study).

Other authors describe Ladikon beach as a site of high ecological and aesthetic value, especially characterized by the dominance of large *Cystoseira* communities (Jeudy De Grissac *et al.*, 1991). This was also confirmed in this study, as highest values in terms of biodiversity and ecological evaluation were found at station R8 in Ladikon bay.

CONCLUSIONS

Although visual sampling methods are known to result in a considerable loss of taxonomic information, this might not be the case when it comes to the ecological quality assessment. Many researchers have already shown that identification to taxonomic levels higher than species (e.g. genera or families) can efficiently detect changes related to anthropogenic disturbances (Warwick, 1988a; 1988b; Urkiaga-Alberdi *et al.*, 1999; Pagola-Cardé *et al.*, 2002; Terlizzi *et al.*, 2003).

In this study, the appliance of the Ecological Evaluation Index on phytobenthic data collected by both destructive and non-destructive sampling resulted in a similar ecological evaluation of the study area. Both methods reflected properly the existing pollution gradient along the northeastern coasts of Rhodes Island, the visual method being by far less laborious and time-consuming.

The combination of visual sampling with the Ecological Evaluation Index seems to constitute a fast and efficient tool for the classification of coastal areas in terms of the WFD Quality Classes. However, much further replication in space and time is yet requisite before we can confirm the method's actual consistency to both scientific and policy demands.

REFERENCES

- Diannelidis T.H., Haritonidis S., Tsekos I. (1977) - Contribution à l'étude des peuplements des algues benthique de quelques régions de l'île de Rhodos, Grèce. *Botanica Marina*, 20 : 205-226.
- EEC (2000) - Council Directive for a legislative frame and actions for the water policy, 2000/60/EC, Official Journal of the E.C., 22/12/2000.
- Jedy De Grissac A., Tilot V., Sinassamy J.M., Panayotidis P. (1994) - Preliminary study on Conservation of the environment of the island of Rhodes. IUCN Marine Programme, Regional Activity Centre for Specially Protected Areas : 69 pp.
- Orfanidis S., Panayotidis P., Stamatis N. (2003) - An insight to the ecological evaluation index (EEI). *Ecological Indicators*, 3(1) : 27-3
- Orfanidis S., Panayotidis P., Stamatis N. (2001) - Ecological evaluation of transitional and coastal waters: A marine benthic macrophytes-based model. *Med. Mar. Sci.*, 2(2) : 45-65.
- Pagola-Carte S., Urkiaga-Alberdi J., Bustamante M., Saiz-salinas J.I. (2002) - Concordance degrees in macrozoobenthic monitoring programmes using different sampling methods and taxonomic resolution levels. *Mar.Poll.Bull.*, 44 : 63-70.
- Salomidi M. (2003) - Hard-bottom benthic communities: towards a new concept in assessing and monitoring marine biodiversity. *MARS Newsletter*, autumn 2003, 6 : 16pp.
- Terlizzi A., Fraschetti S., Guidetti P., Boero F. (2002) - The effects of sewage discharge on shallow hard substrate sessile assemblages. *Mar.Poll.Bull.*, 44 : 544-550.
- Terlizzi A., Bevilacqua S., Fraschetti S., Boero F. (2003) - Taxonomic sufficiency and the increasing insufficiency of taxonomic expertise. *Mar.Poll.Bull.*, 46 : 556-561.
- Tsekos I., Haritonidis S. (1974) - The marine algae of Rhodos Island, Greece. *Br. Phycol. J.*, 9 : 399-406
- Urkiaga-Alberdi J., Pagola-Carte S., Saiz-Salinas J.I. (1999) - Reducing effort in the use of benthic bioindicators. *Acta Oecologica*, 20(4) : 489-497
- Warwick R.M. (1988a) - Analysis of community attributes of macrobenthos of Frierfjord/Langesundfjord at taxonomic levels higher than species. *Mar.Ecol.Prog.Ser.*, 46 : 167-170.
- Warwick R.M. (1988b) - The level of taxonomic discrimination required to detect pollution effects on marine benthic communities. *Mar.Poll.Bull.*, 19 : 259-268.

APPLICATION OF ECOLOGICAL INDICES ON PHYTOBENTHOS DATA FOR THE IMPLEMENTATION OF THE WATER FRAMEWORK DIRECTIVE (WFD, 2000/60/EC)

Sofie SPATHARIS, Panayotis PANAYOTIDIS, Daniel DANIELIDIS and Barbara MONTESANTO

National Center for Marine Research, 19013 Mavro Lithari, Athens, GREECE

ABSTRACT

The efficiency of three original indices to assess environmental impact on benthic macroalgal communities for the purposes of the (WFD) was tested: the Ecological Evaluation Index (EEI) and the Average and Variation in Taxonomic Distinctness (Δ^+ , Λ^+ respectively). The indices were applied for calibration on existing data from a gradient of eutrofication at the Maliakos Bay. The EEI had adequate resolving power especially when relative abundance data was used. For the Taxonomic Distinctness indices, discrimination of disturbed sites is possible by using brown and green algae only. Further examination is necessary after the red algae taxonomic tree is updated.

KEY-WORDS: Phytobenthos, Water Framework Directive, Ecological Evaluation Index, Taxonomic Distinctness

INTRODUCTION

The overall objective of the Framework Directive for the Water Policy (WFD, 2000/60/EC) is that Member States should achieve "good ecological and chemical status" for all waters by December 2015. Phytobenthos is mentioned in the (WFD) as one of the quality elements proposed for the evaluation of the Ecological Status (ES) of coastal and transitional waters. A consistent classification of all European surface waters into Ecological Status Classes (ESC) is necessary.

Since the WFD came into force, research has been intensified towards the development of new indices for the ecological evaluation of coastal ecosystems. In Greece, Orphanidis *et al.* (2001) have developed an original biotic index based on a functional-form model, called the Ecological Evaluation Index (EEI) exclusively for phytobenthos data of transitional and coastal waters. Two other original indices that are closely related to functional diversity are the Average Taxonomic Distinctness Δ^+ and Variation in Taxonomic Distinctness Λ^+ , developed by Warwick & Clarke (1995, 2001) and were originally applied on zoobenthos data. The aim of the present study was first to apply the two taxonomic distinctness indices on macroalgal data and assess their "reaction" to increased environmental stress, and second to define the resolving power of the EEI index. For this purpose, macroalgal data from a eutrofication gradient of a coastal area was used.

MATERIALS AND METHODS

The indices were applied on existing data from the Maliakos Bay (Aegean Sea, Greece) (Chrysosvergis & Panayotidis, 1995). The data was quantitative and consisted of a set of five stations along an eutrofication gradient (Fig. 1) for two years (summer and winter months).

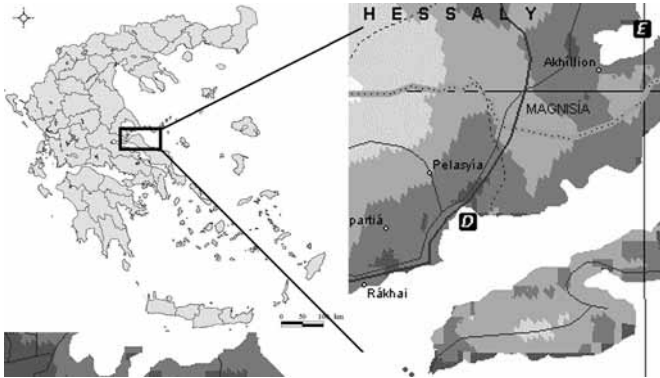

Fig 1: Map of Maliakos Bay (Greece) showing the five sampling stations along a eutrofication gradient from the Sperchios River mouth (stations A & B), from where there is an important nutrient input, towards the Aegean Sea (stations C & E).

The Ecological Evaluation Index

The EEI was calculated according to Orfanidis *et al.* (2001). The macrophyte species were divided in two Ecological State Groups. In ESG I were grouped the thick leathery, the articulate upright calcareous and the crustose calcareous species, most of them being *k*-selected species. In ESG II were grouped the foliose, the filamentous and the coarsely branched upright species. Most of them are *r*-selected species. Each sampling site was classified in one of the five ESC after a cross-comparison of the mean abundance value of the ESG I and II, on a matrix. Additionally to the mean abundance value, the relative abundance value for the two groups was applied.

Taxonomic diversity indices

According to Warwick & Clarke (2001) the average taxonomic distinctness, Δ^+ , is the mean number of steps up the hierarchy that must be taken to reach a taxonomic rank common to two species, computed across all possible pairs of species in an assemblage. The species are placed within a taxonomic hierarchy, based on the Linnean classification (phylum, class, order, family, and genus). Thus, if two species are congeneric, one step (species-to-genus) is necessary to reach a common node in the taxonomic tree. If the two species belong to different genera but the same family, two steps will be necessary (species-to-genus, and genus-to-family); and so on, with these numbers of steps averaged across all species pairs. If Δ^+ is the mean path length through the taxonomic tree connecting each pair of species, Δ^+ is simply the variance of these pairwise path lengths and could be seen as an index of the "complexity" of the hierarchical tree (Fig. 2).

The average taxonomic distinctness (Δ^+) (Warwick & Clarke 2001) with the formula:

$$\omega_{\mu} = \left[\sum \sum_{i < j} \omega_{ij} \right] / [s(s-1)/2]$$

where s is the species richness and ω_{ij} is the «distinctness weight» given to the path length linking species i and j in the hierarchical classification.

The “variation in taxonomic distinctness” Δ^+ can be expressed by:

$$\Delta^+ = \left[\sum \sum_{i < j} (\omega_{ij} - \omega_{\mu})^2 \right] / [s(s-1)/2]$$

$$= \left[\left\{ \sum \sum_{i < j} \omega_{\mu}^2 \right\} - \{s(s-1)/2\} \right] - \omega_{\mu}^2 \quad \text{where} \quad \omega_{\mu} = \left[\sum \sum_{i < j} \omega_{ij} \right] / \{s(s-1)/2\} \equiv \Delta^+$$

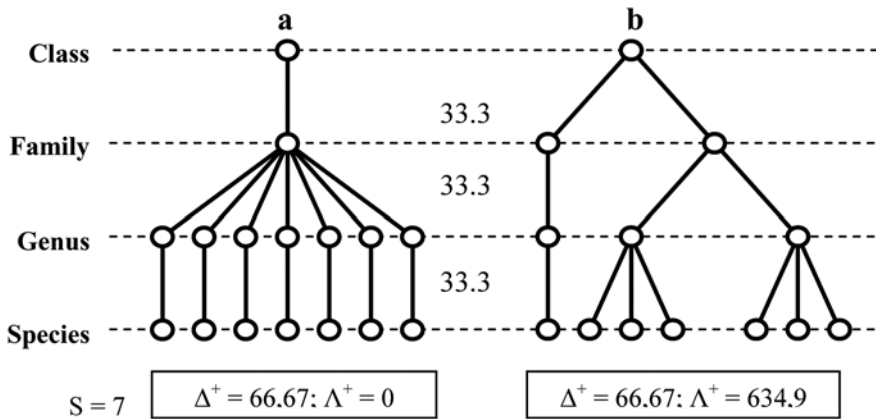

Fig. 2: Two theoretical trees (a and b) with the same richness (7 species) but with a different taxonomy. The mean path length between species is the same for the two trees and thus Δ^+ is identical. The tree structure has a greater unevenness or variability in (b) compared to (a), thus the variation in taxonomic distinctness (Λ^+) is higher for (b). The «distinctness weight» given to the path length between each taxonomic level is 33.33 with a total of 4 levels. Step lengths are standardized so that the distinctness of two species connected at the highest taxonomic level is set equal to 100. Δ^+ ranges between 0 and 100, and Λ^+ is positive (Warwick & Clarke, 2001).

To check for any stations deviating from the expected, the Δ^+ and Λ^+ values for each station were plotted in a probability funnel with 95% confidence limits. The simulated mean against which they were compared was the Δ^+ and Λ^+ value of a “master list” from all the species of green, brown and red algae found in the Greek seas. The taxonomic structure of this master list came from the check lists of Gallardo *et al.* (1993) for the brown algae, Ribera *et al.* (1992) for the green algae, and Athanasiadis (1987) for the red algae, except the Ceramiaceae by Gómez Garreta *et al.* (2001).

RESULTS

The EEI numerical values vary from 2 (Ecological Status: "Bad") near the river mouth (st. A) to 8 (ES: "High") at the Aegean Sea (st. E) with the intermediate stations (B, C and D) having a value of 6 (ES: "Moderate"). When relative abundance data is used the index is showing a more distinct gradient from river mouth to the open sea (Fig. 3).

When the Δ^+ and Λ^+ indices were applied for green, brown and red algae, the values did not show as great variation as they did when applied for the groups of green and brown algae only. When green and brown algae were used, the Δ^+ index was negatively correlated to eutrofication, while the Λ^+ index presented the opposite trend, showing an increase with increased eutrofication (Fig. 3).

The probability funnels for Δ^+ and Λ^+ indices when all groups of macrophytes were used, showed that all stations at all four sampling seasons present no significant variation from the expected Δ^+ and Λ^+ values of the master list. However, when red algae were excluded from the analysis, most seasonal samples of station A and some of B showed a significant deviance from the expected for both indices.

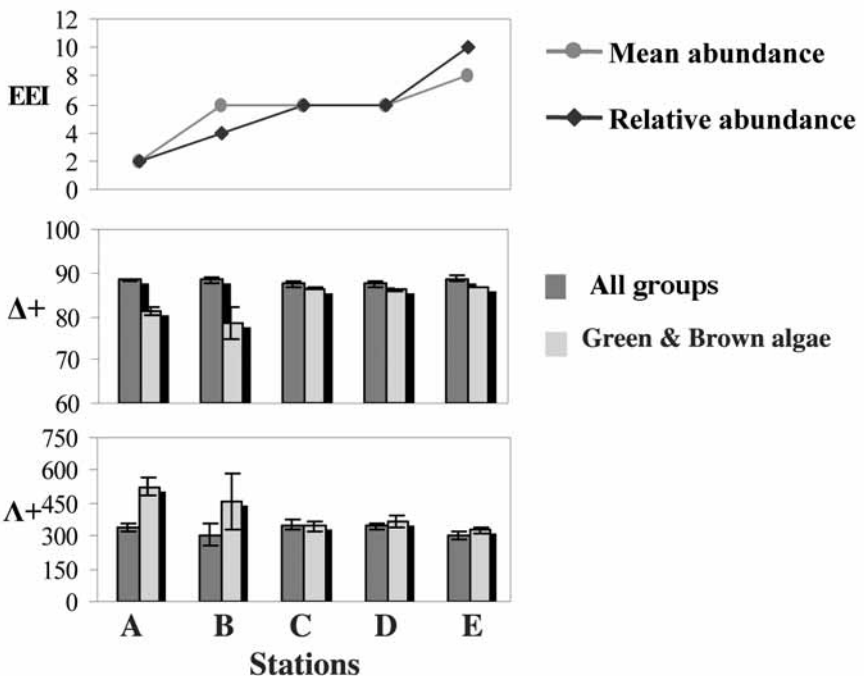

Fig. 3. Graphic representation of the three original indices: EEI applied for both mean and relative abundance data, and Δ^+ and Λ^+ taxonomic diversity indices applied for all three groups of algae and for green and brown algae only.

On Fig. 4 each of the five stations contains four samples from four different months. Dashed lines indicate the simulated mean from a 5000 random selections from a master list of 513 species of the Greek seas. Continuous lines represent the 95% confidence intervals and define the area where any Δ^+ or Λ^+ value, for a given number of species, lies within the "expected" range.

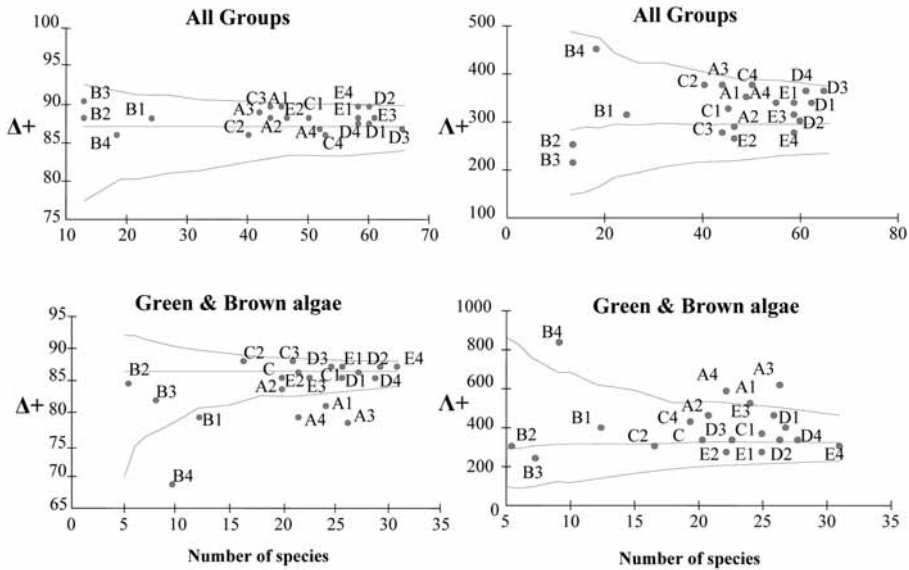

Figure 4: Average taxonomic distinctness Δ^+ , and Variance in Taxonomic Distinctness Λ^+ values, plotted against the observed number of species for two cases: using all groups of algae and excluding the red algae group.

DISCUSSION AND CONCLUSIONS

The EEI has adequate resolving power to discriminate between disturbed sites. From the results in the specific area the EEI seemed to perform better when relative abundance data were used. Relative abundance intensifies the difference of percentages of the two Ecological State Groups of species proposed by Orfanidis *et al.*, (2001).

Taxonomic diversity indices can be very useful, as they can perform on qualitative data, and their independence of sample size makes them suitable for comparisons of different regions, studies etc. Overall the two taxonomic distinctness indices performed better when the red algae group was excluded from the analysis. This could be due to the fact that the number of red algae species is three times greater than the number of the green and brown algae species. This is affecting the balance of the taxonomic tree and needs further examination.

For green and brown algae only, the Δ^+ and Λ^+ indices seemed to perform sufficiently in distinguishing the two most disturbed sites, although they did not clearly depict the gradient of pollution. The results indicate that when the average taxonomic distinctness decreases, the unevenness in phylogenetic structure indicated by Λ^+ increases.

REFERENCES

- Athanasiadis A. (1987) - A survey of the Aegean Sea, with taxonomic studies on the species of the tribe Antiithamnieae (Rhodophyta). PhD Thesis, University of Goteburg : 174 pp.
- Chrysovergis F. et Panayotidis P. (1995) - Évolutions des peuplements Macrophytobenthiques le long d'un gradient d'eutrophication (Golfe de Maliakos Mer Égée, Grèce). *Oceanologica Acta*, 18 (5).
- Clarke K. R. & Warwick R. M. (1998) - A taxonomic distinctness index and its statistical properties. *Journal of Applied Ecology*, 35 : 523-531.
- EEC (2000) - Council Directive for a legislative frame and actions for the water policy, 2000/60/EC, Official Journal of the E. C. 22/-12/2000
- Gallardo T., Gómez Garreta A., Ribera M. A., Cormaci M., Furnari G., Giaccone G. & Boudouresque C. F. (1993) - Checklist of Mediterranean Seaweeds. II. Chlorophyceae. *Bot. Mar.*, 36 : 399-421
- Gómez Garreta A., Gallardo T., Ribera M. A., Cormaci M., Furnari G., Giaccone G. & Boudouresque C. F. (2001). - Checklist of Mediterranean Seaweeds. III. Rhodophyceae Rabenh. 1. Ceramiales Oltm. *Bot. Mar.*, 44 : 425-460.
- Orfanidis S., Panayotidis P. and Stamatis N. (2001) - Ecological evaluation of transitional and coastal waters: A marine benthic macrophytes-based model. *Mediterranean Marine Science*, 2(2) : 45-65.
- Ribera M. A., Gómez Garreta A., Gallardo T., Cormaci M., Furnari G. & Giaccone G. (1992) - Checklist of Mediterranean Seaweeds. I. Fucophyceae. *Bot. Mar.*, 35 : 109-130
- Warwick R. M. & Clarke K. R. (1995) - New 'biodiversity' measures reveal a decrease in taxonomic distinctness with increasing stress. *Mar. Ecol. Prog. Ser.*, 129 : 301-305.
- Warwick R. M. & Clarke K. R. (2001) - Practical measures of marine biodiversity based on the relatedness of species. *Oceanography and Marine Biology: an Annual Review*, 39 : 207-231.

OVERVIEW OF THE ACTIVITIES AIMED AT A LONG-TERM CONSERVATION OF THE *POSIDONIA OCEANICA* MEADOW ON THE SLOVENIAN COAST

Robert TURK

Institute of the Republic of Slovenia for Nature Conservation, Regional Office Piran, Tartinijev trg 12, 6330 Piran, R Slovenia

ABSTRACT

Posidonia oceanica (L.) Delile is listed in Annex II of the Protocol concerning Specially Protected Areas and Biological Diversity in the Mediterranean as endangered species, while the EU Habitat Directive 92/43/EEC of 21st of May 1992 defines its meadows as priority habitat type. The protection of *Posidonia oceanica* and its meadows is thus one of the top priorities in the field of nature conservation. In this sense a Memorandum of Understanding was signed between the Principality of Monaco, RAC/SPA and the Institute of the Republic of Slovenia for Nature Conservation. It enabled several activities, with the aim to achieve a better knowledge on the extension of the meadow and on its ecological parameters, to set the basis for a long-term monitoring and to raise public awareness.

KEY-WORDS: North Adriatic, Slovenia, *Posidonia*, conservation, cooperation

INTRODUCTION

Posidonia oceanica (L.) Delile is, together with *Cymodocea nodosa* (Ucria) Ascherson, the most common seagrass in the Mediterranean. It is widespread in the whole basin except for the area close to the strait of Gibraltar, the North Adriatic, the coast of Israel, the Bosphorus, the sea of Marmara and the Black Sea. According to Benacchio (1938) it was quite common also on the silty bottom of the Gulf of Trieste in the North Adriatic. Further investigations however showed a drastic change in its distribution in this northernmost part of the Adriatic (Vukovic, 1982). It is very likely that at present there is only one very restricted meadow of *Posidonia oceanica* in the Gulf of Trieste. The area is on the Slovenian coast between the towns of Koper and Izola. A preliminary and approximate mapping of the area that was carried out in 1993 showed that the meadow is approximately 1 km long, starts close to the coastline and extends 50 m off shore-water depth app. 4 m (Vukovic and Turk, 1995, Turk *et al.*, 2002).

Up to now the area of the meadow is included in the state and local physical plans as future protected area and at the same time *Posidonia oceanica* is listed in the governmental decree on rare and endangered species that was adopted by the Slovene parliament in 2002. Further more it is listed in Annex II of the Protocol concerning Specially Protected Areas and Biological Diversity in the Mediterranean as endangered

species while the EU Habitat Directive 92/43/EEC of 21st of May 1992 defines its meadows as priority habitat type. The protection of *Posidonia oceanica* and its meadows is thus one of the top priorities in the field of nature conservation. However, in order to properly define the potential threats and therefore apply efficient conservation measures to this unique meadow, further research and monitoring was necessary.

The importance of further research and monitoring is even greater due to the foreseen changes concerning the main coastal road that is now going along and very close to the coastline. The new coastal road, that is bound to be built in the forthcoming years, will be moved into a tunnel, and will as a consequence, "free" the coastline and make it available for other activities, mainly recreation and tourism. Due to that, increased pressure for beach enlargement, piers, maritime traffic and other recreational and tourist facilities is expected. Without a proper legislation, accurate maps of the sea bottom and its habitat types, a well-defined monitoring and awareness campaign, the expected pressure for the development of recreational facilities could jeopardise the conservation of the meadow.

MEMORANDUM OF UNDERSTANDING

In the framework of the SAP BIO project (Strategic Action Plan for the Conservation of marine and coastal biodiversity in the Mediterranean region), carried out by the Regional Activity Centre for Specially Protected Areas in Tunis, National Reports were prepared in order to define the state of art in the field of biodiversity conservation and foresee the due future activities. In the Slovene As a follow-up of the National Report, a National Action Plan for the conservation of the *Posidonia oceanica* meadow was drafted. Its main objectives are in line with the Action Plan for the conservation of marine vegetation in the Mediterranean Sea, adopted by the contracting parties to the Barcelona Convention in the year 1999 and with the provisions of the EU Habitat directive. The main targets of the action plan could be summed as follows:

- legal protection of *Posidonia oceanica* and the establishment of a protected area that would include the meadow;
- better knowledge of the extension of the area covered by *Posidonia oceanica* based on an accurate cartography of the meadow;
- better knowledge on the main ecological parameters in the area covered by the meadow;
- raising public awareness.

The possibility to carry out most of the activities, foreseen in the action plan, came with the signature of a Memorandum of Understanding (referred hereafter as MoU) between the Institute of the Republic of Slovenia for Nature Conservation, the International Cooperation for Environment and Development of the Principality of Monaco and the Regional Activity Centre for Specially Protected Areas (RAC/SPA) of the Barcelona Convention. According to the MoU, the Institute of the Republic of Slovenia for Nature Conservation, through its Regional Office Piran, should carry out activities aimed at ensuring an efficient, long-term conservation of the *Posidonia oceanica* meadow and will

at the same time fulfill some of the actions foreseen in the mAP Action Plan for the Conservation of Marine Vegetation in the Mediterranean Sea. To undertake these activities, financial support would be granted by the International Cooperation for Environment and Development of the Principality of Monaco and RAC/SPA.

ACTIVITIES CARRIED OUT IN THE FRAMEWORK OF THE MOU

The implementation of the activities foreseen in the action plan and financed according to the MoU were carried out the year 2003. The Regional Office in Piran coordinated all the activities and at the same time tried to "use" them as a tool to increase public awareness concerning nature conservation. A short description of the activities is given hereafter.

Aerial photography



Fig. 1: DOF of the area.

Mapping of seagrass meadows has become an indispensable tool not only for developing and managing the coastal area but also for a proper research and monitoring of the structure and dynamics of the meadows in view of their management and protection. Aerial photography and further image processing appears to be a technique which is particularly suitable in shallow waters, as it is the case of the investigated meadow. The aerial photographs were taken and processed in winter 2002/2003 in order to ensure greater transparency of the water and at the same time take advantage of the "absence" of *Cymodocea nodosa* meadows. The results of aerial photography were checked later on by SCUBA diving. On the basis of aerial photos and field data a map of the meadow was elaborated. The task was carried out with the collaboration of the Group for Coastal Ecosystems at the University of Corsica.

Study of the main ecological parameters in the meadow

In order to improve our knowledge on the environmental conditions that influence the development of the meadow; a programme for the study of the main ecological parameters was prepared in collaboration with the National Institute of Biology - Marine Biology Station in Piran. The investigation, which was carried out twice – winter and summer 2003, included the investigation of the following parameters:

- light conditions on the sea bottom;
- sedimentation rate;
- mikrophytobenthos species;
- mikrophytobenthos primary production;

- meiofauna species;
- nutrients in interstitial water;
- sediment metabolism expressed through respiration.

Marking the lower limit of the meadow

In order to be able to monitor the development of the meadow, 6 marks were placed at its lower limit while 4 of them were used to mark the outer border of one single patch. In accordance with the methodology used in GIS Posidonie, photographs of the situation were taken in order to enable the follow-up of the evolution of the meadow and the eventual changes in its lower limit.

Installing signposts

Due to the fact that the meadow is located in an urbanised area with a rather intense recreational use, especially in summer, the signposts represent an important tool in spreading the awareness on the importance of the meadow and its conservation. Taking into account the specificity of the area, five signposts, explaining the main characteristics and importance of *Posidonia oceanica* and the conservation measures adopted, were foreseen.

Increasing public awareness

As mentioned above, all the activities were used as a tool to increase public awareness concerning the importance of the meadow and the need for its conservation. However a special event was organised in order also to inform the public on the activities carried out in the framework of the project. The event included a press conference, a field trip, lectures by Gerard Pergent and Christine Pergent-Martini from the University of Corsica and the opening of an exhibition dedicated to *P. oceanica* meadows, their importance and role.

CONCLUSIONS

The implementation of the activities foreseen in the Memorandum of Understanding was carried out successfully and what is even more important; they were very well accepted by the general public and the local authorities. One of the direct consequences of the activities is the inclusion of the results of the mapping in the elaboration of the plans for the future development of the area. Beside that, the results of the activities – mapping, marking of the lower limit etc. represent the necessary basis for the implementation of a long-term monitoring of the area and the definition of effective measures for the conservation of the meadow.



Fig. 2 : Lecture by prof. Pergent

POSTERS

MARINE VEGETATION ASSEMBLAGES AND BENTHIC BIONOMY IN CYPRUS.

Marina ARGYROU¹, Just T. BAYLE², Chedly RAIS³, Alfonso A. RAMOS-ESPLÁ²,
Pablo SÁNCHEZ-JÉREZ² & Carlos VALLE²

(1) : Department of Fisheries and Marine Research, Cyprus

(2) : Unidad de Biología Marina, University of Alicante, Spain.

(3) : Regional Activity Center for Special Protected Areas (RAC/SPA), Tunisia.

ABSTRACT

Three localities in Cyprus have been observed (Cape Greco, Moulia Rocks and Akamas Peninsula) and mapped, 0-70m depth ranges by direct sampling (SCUBA and snorkelling) and remote sampling (trawl, dredge) on hard and soft bottoms, as part of the RAC/SPA-EU MedMPA project. It is analysed the dominant vegetation assemblages: i) littoral rocks *Spongites-Dendropoma* and *Lithophyllum* spp. formations; ii) upper infralittoral rocky bottoms with *Cystoseira* spp. forests; iii) upper circalittoral rocks with *Caulerpa racemosa* and *C. prolifera*, and Fucales; iv) seagrass meadows in rocky bottoms (*Posidonia*) and soft bottoms (*Posidonia*, *Cymodocea* and *Halophila*); v) coastal detritic bottoms with Corallinaceae (*Lithothamnion*, *Phymatolithon*), Peyssonneliaceae (*Peyssonnelia* spp.) and *Palmophyllum crassum*.

MARINE MACROPHYTOBENTHOS OF CYPRUS

Marine ARGYROU and Myroula HADJICHRISTOPHOROU

*Environment Division, Department of Fisheries and Marine Research, Ministry of Agriculture, Natural Resources and Environment,
13 Aeolou Str., 1416 Nicosia, Cyprus*

ABSTRACT

In this study we report, a comprehensive list of the marine macrophytobenthos of Cyprus is presented for the first time. A total of 70 species recorded, of which 4,3 % are seagrasses, 4,3 % are Cyanophyceae, 30 % are Chlorophyceae, 27,1 % are Phaeophyceae and 24 % are Rhodophyceae. A 5,7 % of the total macrophytobenthos species is represented by Lessepsian migrants, from which the species, *Caulerpa racemosa*, has a prominent colonization along the Cyprus coast.

MARINE VEGETATION ASSEMBLAGES AND BENTHIC BIONOMY IN THE ZEMBRA-ZEMBRETTE NATIONAL PARK (TUNISIA).

Just T. BAYLE¹, Karim BEN MUSTAPHA², Adel BOUJAJINA,³ Saba GUELLOUZ⁴, Atef LIMAN³,
Chedly RAIS³, Alfonso A. RAMOS-ESPLA¹, Pablo SANCHEZ-JEREZ¹ & Carlos VALLE¹

(1) : *Unidad de Biología Marina, University of Alicante, Spain.*

(2) : *Institut National de Sciences et Technologies de la Mer, Tunisia.*

(3) : *Regional Activity Center for Special Protected Areas (RAC/SPA), Tunisia.*

(4) : *Agence pour la Protection et Aménagement du Littoral (APAL), Tunisia.*

ABSTRACT

During two cruises (2002 and 2003) the marine vegetation assemblages around the Zembra-Zembretta National Park have been observed and mapped, 0-75m depth ranges by direct sampling (SCUBA and snorkelling) and remote sampling (dredge) on hard and soft bottoms, as part of the RAC/SPA-EU MedMPA project. It is analysed the dominant vegetation assemblages: i) littoral rocks *Spongites-Dendropoma* formations; ii) infralittoral rocky bottoms with *Cystoseira* spp. and *Dictyopteris polypodioides* forests; ; iii) upper circalittoral rocks with deeper *Cystoseira* spp.; iv) seagrass meadows in rocky bottoms (*Posidonia*) and soft bottoms (*Posidonia* and *Cymodocea*); v) coastal detritic bottoms with Corallinaceae (*Lithothamnion*, *Phymatolithon*).

LES VEGETAUX MARINS, DES RESSOURCES EXPLOITABLES EN NUTRITION ANIMALE. APPLICATION A LA FORMULATION D'ALIMENTS POUR LES MONOGASTRIQUES

Jamel KSOURI¹, Fethi MENSI¹, Jamel REKHIS², Adel ABASSI² et Rachid AOUIJENE²

1 Institut National des Sciences et Technologies de la Mer (INSTM)

2 Ecole Nationale de Médecine Vétérinaire (ENMV)

ABSTRACT

L'objectif de ce travail est la recherche d'une substitution partielle, au niveau de aliments utilisés dans les élevages avicoles et cunicoles des intrants importés (tourteau de soja, maïs et luzerne) par une matière première marine locale.

Cinq espèces de végétaux marins ont été sélectionnées, sur la base de leur abondance à certaines périodes de l'année soit en épave soit dans le milieu dans le milieu aquatique (lacs et mer), pour une éventuelle utilisation en nutrition animale. Il s'agit des trois phanérogames *Posidonia oceanica*, *Ruppia maritima* et *Cymodocea nodosa* ainsi que des deux algues vertes *Chaetomorpha linum* et *Ulva lactevirens*

En se référant d'une part à la composition chimique de ces végétaux et d'autre part aux besoins nutritionnels des deux mono gastriques d'élevage, le poulet de chair et le lapin, *Ulva* et *Ruppia* ont été retenues en vue de leur incorporation dans la ration des deux animaux en question. Ces deux espèces végétales se caractérisent respectivement par les compositions chimiques suivantes : protéines brutes 14 % - 13,48%, cellulose brute 6,19% - 16,41, matières grasses 2,47% - 2,81% et matières minérales 56 % - 43,37%.

Pour le poulet de chair et en plus de l'aliment témoin (A), trois aliments (B : 20 % *Ulva*, C : 10 % *Ruppia* et D : 10 % *Ulva* + 5 % *Ruppia*) ont été formulés à partir des ingrédients suivants : maïs, tourteau de soja, CMV, huile végétale, *Ulva* et *Ruppia*. La composition chimique et la valeur nutritive des quatre aliments sont respectivement les suivantes (phase de finition) : protéines 19,5 % - 18,3 % - 17,6 % - 24,4 % / cellulose brute 4 % - 3 % - 4 % - 5 % / matières minérales 5,6 % - 11,8 % - 6 % - 12 % / énergie métabolisable (kcal / kg MS) 3413,17 – 3330,06 – 3346,45 – 3093,41.

Pour le lapin et en plus de l'aliment témoin (T), deux aliments (U : 6 % Ulva et R : 6 % Ruppia) ont été formulés à partir des ingrédients suivants : son de blé, luzerne, orge, tourteau de soja, CMV, Ulva et Ruppia. La composition chimique et la valeur nutritive des trois aliments sont respectivement les suivantes : protéines 19,2 % - 19,6 % - 18,3 % / cellulose brute 13 % - 12 % - 11 % / matières grasses 3,4 % - 3,2 % - 4 % / matières minérales 10 % - 11,8 % - 9,2 % / énergie digestible (kcal / kgMS) 2486 – 2481 – 2500.

Mission relative au développement d'Aires



Projet Régional pour le Développement d'Aires Protégées Maritimes
RAC - SPA Tunis / Ministry of State for Environmental Affairs

Résultats préliminaires issues des deux missions de terrain menées par : G. BITAR, G. TORCHIA, F. ...
Les sites remarquables

Le nord de la côte syrienne, à la frontière Turque, présente un intérêt certain du point de vue paysager, géomorphologique, écologique, floristique, faunistique et biologique. Tous les ingrédients y sont réunis pour qu'un éventuel Parc Marin transfrontalier voit le jour dans le cadre d'une coopération en ce sens entre la Syrie et la Turquie.



Frontière Syro-Turque vue de la vallée de Samra



COÛTE À LA MONTAGNE, PAYSAGE DE BORA ISLAM

Bora Islam : fond au relief tourmenté formé de récifs potatoïdes fortement convexes et de grandes dalles rocheuses. L'intérêt de la zone entre Bora Islam et Um Tair est renforcé par les installations effectuées par les pêcheurs locaux qui capturent des espèces pour le moins singulières (requin marcais, rale Manta ...etc.).



Axinella polypoides / Tambour au large de Ras El Bassit -53m



Pelagia (Gastropode) au large de Ras El Bassit

Globalement, la richesse ichtyologique est indéniable (le grand nombre d'espèces capturées par les pêcheurs interrogés en témoigne), mais la pauvreté en faune fixée des sites explorés est notable et mérite d'être étudiée plus en détails. Seuls de rares organismes dressés comme l'éponge Axinella polypoides ont été observés mais à de grandes profondeurs (entre 50 et 63 mètres de profondeur). Le secteur situé entre le Cap du Porc (Sud d'Um Tair) et le Sud de Ras El Bassit semble majoritairement constitué par de grandes étendues sableuses. En revanche, sous la partie de Ras El Bassit, y compris au large, semble être plus intéressante du point de vue biologique et paysager (nombreux bancs rocheux commençant vers -30m avec la découverte d'une vaste grotte au pied de l'un de ces bancs vers -53m, et des espèces d'intérêt patrimonial : Grande cigale, mérou brun, oursin gladème...etc.)

Les espèces lessepsiennes

La migration lessepienne est un phénomène continu qui permet le passage unidirectionnel d'espèces tropicales de la mer Rouge vers la Méditerranée orientale via le canal de Suez. Le canal de Suez, ouvert en 1869, est un filet d'eau à l'échelle d'un océan, pourtant, 5 % des espèces vivent en Méditerranée, ont emprunté ce canal et sont originaires de Mer Rouge.



Récemment, certaines espèces lessepsiennes, trouvant dans la partie orientale de la Méditerranée une mer salée et sous-peuplée, un environnement approprié, s'y sont établies et s'étendent actuellement lentement vers l'ouest. L'exemple de Holophilus striolaceus, entrée en Méditerranée peu après l'ouverture du canal de Suez (inventoriée la première fois en méditerranéen en 1885), et qui a progressivement colonisé le bassin occidental pour atteindre les Iles de Malte, est symptomatique du phénomène. Ce dernier représente pour Gijón une occasion unique d'étudier le processus d'invasion et de colonisation d'une région sub-tropicale peuplée d'organismes de milieu tempéré, par des organismes d'eaux tropicales.

A ce phénomène de migration lessepienne, il convient d'ajouter l'influence du changement climatique sur les espèces de poissons et les écosystèmes qui affecte de façon notable la biodiversité marine dans son ensemble. On assiste ainsi, selon certains, à une véritable tropicalisation de la Méditerranée. Le phénomène de tropicalisation est particulièrement marqué au niveau des poissons (environ une espèce sur trois serait originaire de mer rouge).



Sergoacentrum rubrum



Poisson lapin à ventre strié - Siganus rivulatus

Photo réalisée par Mohamed Dahoug de la Direction Nationale des Ressources Halieutiques et de la Pêche Sportive (DNRH) - Photographie sous-marine

Symbole de cette tropicalisation de la Méditerranée



Végétation sous-marine du l...

Prasidocystis à Penicillium capitatus et Cylindrocapsa capitiformis (200m) forment des chaînes des étages, lors des (trialis).

Fond de sable protégé par Penicillium capitatus et Cylindrocapsa capitiformis (voir Lamarck, 1817) et d'un autre de nombreux Jubbah - 5

Neomeris annulata (Dickie) : espèce non citée dans la thèse de MAYMOUB (1976). Elle semble s'être introduite en Méditerranée. C'est sans doute la nouvelle espèce pour la Syrie et la Méditerranée. D'origine indopacifique, elle est présente en Mer Rouge, dans le Sinai (MAR)

Le Mérou brun - Epinephelus

L'abondance de juvéniles de mérous bruns offre un contraste nord-occidentales de Méditerranée et par là même un en son genre (travaux sur le recrutement, génétique des



Sur la quarantaine de plongées effectuées depuis le nord (Ras El Bassit) jusqu'à l'île d'Arwad, au sud, entre 10 et 63 mètres de profondeur, seuls des individus juvéniles ont été observés. Quelques rares pêcheurs interrogés ont signalé avoir déjà capturés des adultes, mais leur présence reste à déterminer.

Marines Protégées sur les côtes syriennes

Marines et Côtières dans la région méditerranéenne (MedMPA)

Environmental Affairs of Syria / ATEN France

F. BABALAMENTI, D. CEBRIAN-MENCHERO, R. DUPUY de la GRANDRIVE et M. FOULQUIE



...inée ; cette photo où se côtoient poissons #cureuil (*Holocentrum aurocentron rubrum*) venus de mer rouge via le canal de Suez et les castagnoles (*Chromis chromis*), poisson typiquement méditerranéen, sur un fond de végétation mêlée de *Posidonia pavonica* (algue brune de Méditerranée) et de l'algue *Neomeris annulata* (cf. page) d'origine indo-pacifique et répartie sur l'ensemble de la zone intertropicale (île d'Arwad, - 13m de profondeur).

Les sites explorés :

Du Nord de la Syrie (frontière turque), à l'île d'Arwad au Sud, une dizaine de sites majeurs ont été prospectés en une quarantaine de plongées.

- Ras Samra
- Pigeon Island
- Ras El Bassit
- secteur Sud de Ras El Bassit
- Um Tliur
- Borg Islam
- Nord de Lattakia (les chalets)
- Ibn Hanl (Institut de biologie marine de Lattakia)
- île d'Arwad

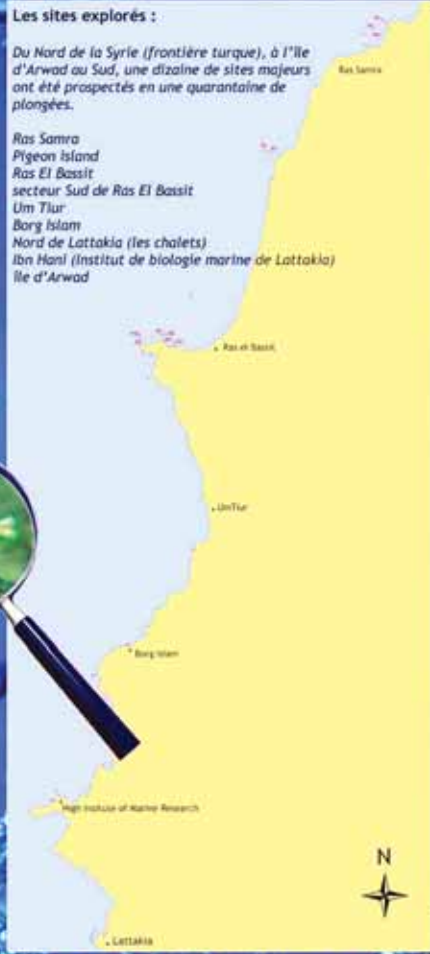

littoral syrien

Membre de *Cymodocea* avec l'algue *Pennellus capillatus*

pour les algues *Costerop* (rouge)

Algue

à observer dans - 30 mètres de profondeur

Hypopodium schimperii

algues de l'île d'Arwad sembleraient être le résultat d'un espèce invasive, colonisant le littoral syrien par substrats durs de la Méditerranée et algues autochtones

19485, 1947, L'ARWAK, 19457

s marginatus

traste saisissant avec les (un champ d'étude unique, les populations...)



La richesse de la faune ichthyologique marine de la Syrie

Copyright M. Foulquie

Muraena helena - Murène commune

Grundin valanti - *Dactyloperca valanti*

Serranus scriba - *Serranus scriba*

Pomacentrus - *Sparus* crême

Razan - *Xylichthys novacula*

MAPPING OF THE *POSIDONIA OCEANICA* MEADOW ON THE SLOVENIAN COAST

Tihomir MAKOVEC¹ & Robert TURK²

¹ Marine Biology Station Piran, National Institute of Biology, Fornace 41, 6330 Piran, Slovenia

² Institute of the Republic of Slovenia for Nature Conservation, Regional Office Piran, Tartinijev trg 12, 6330 Piran, Slovenia

INTRODUCTION

Mapping of seagrass meadows has become an indispensable tool for a proper research and long-term monitoring of the meadows in view of their management and protection. A preliminary investigation on the size and morphological features of the *Posidonia oceanica* (L.) Del. meadow on the Slovenian coast was carried out by SCUBA divers already in 1993 (Vukovic & Turk, 1995). More accurate methods were needed in order to state stability, progression or regression of the meadow and to take proper conservation measures. A Memorandum of Understanding (2002) between the Institute of the Republic of Slovenia for Nature Conservation, the International Cooperation for Environment and Development of the Principality of Monaco and the Regional Activity Centre for Specially Protected Areas (RAC/SPA) of the Barcelona Convention enabled the financing of aerial photography and the elaboration of a map of the meadow.

Study area

The study area is located in the Gulf of Trieste (northern Adriatic), between the towns of Izola and Koper, with the only site of *P. oceanica* seagrass meadow along the northern and western coasts of Istria. The patches of *Posidonia* are situated between stony coastline and mud bottom, at a depth from 0.5 to 4 m. The area is 1 km long and 50 m wide. The meadow density varies between 360 and 588 shoots/m². The area is a known tourist resort with many recreational activities and has been subjected to some extent to organic pollution from the city of Koper.

Mapping and monitoring

A special emphasis was laid on underwater mapping of different habitat types (Turk *et al.*, 2002). The underwater inspection of the area was carried out at five sampling stations in the years 2000-2001. The diver with camera followed the transect rope and filmed all habitat types. The coverage of each habitat type was calculated from the habitat type distribution drawings.

Aerial photography and further image processing appears to be a technique which is particularly suitable in shallow waters (Pasqualini *et al.*, 1998). The aerial photographs of the meadow were taken during winter 2002/2003, in the period of greater transparency of the water and when the nearby *Cymodocea nodosa* meadow is not yet grown. The results were checked out by SCUBA diving in the following months. Aerial photographs

were further elaborated in the workshop on meadow cartography and image treatment with the program Multiscope 4.2. in Corte, organised by RAC/SPA and the "Coastal Ecosystems Group" of the University of Corsica.

Checking of the results of aerial photography by SCUBA diving confirmed the suitability of this method in shallow waters. The areas with *P. oceanica* could be distinguished very precisely from other habitat types already from the DOF. The surface of the sea bottom covered by *P. oceanica* was calculated to be 0.63 ha. The results of the mapping were used also to define the lower border of the meadow. Only in this way we will be able to monitor the spreading or regression of *P. oceanica* in the Slovenian coastal sea.

REFERENCES

- Vukovi_ A. & R. Turk (1995) - The distribution of the seagrass *Posidonia oceanica* in the Gulf of Koper. Preliminary report. Rapp. Comm. int. Mer Medit, 34.
- Turk R., M. Orlando Bonaca, T.Makovec, A. Vukovic & L. Lipej (2002) A - topographical survey of habitat types in the area characterized by seagrass meadow of *Posidonia oceanica* in the southern part of the Gulf of Trieste (northern Adriatic). Annales, 12 (2):191-202.
- Pasqualini, V., C. Pergent-Martini, P. Clabaut & G. Pergent (1998) - Mapping of *Posidonia oceanica* using aerial photographs and side scan sonar: application off the Island of Corsica. Est., Coast & Shelf Sci., 47, 359-367.

SEAGRASS ECOSYSTEMS AS BIOLOGICAL INDICATORS.
A COMPARISON OF TWO APPROACHES: LEAF EPIPHYTE TAXONOMY
AND A COMBINED SET OF BIOLOGICAL DESCRIPTORS

Begoña MARTINEZ, Adriana VERGÉS TRAMULLAS, Patricia PRADO, Javier ROMERO and Teresa ALCOVERRO.

ABSTRACT

The main objective of the present study is the comparison of two separate approaches to the use of *P. oceanica* meadows as biological indicators of water quality. One is based on the use of a combined set of biological descriptors (physiological, morphological, structural, communal and environmental) and the other is based on the taxonomy of leaf epiphytes. Both sets of descriptors were measured in 12 locations, eight of which were deep (15 m) and four of which were shallow (5 m). The selection of these locations was based on a previous four-year seagrass monitoring study and was aimed at the homogenous cover of a wide range of water qualities, from poor to quasi-pristine conditions. Principal component analysis (PCA) applied to a set of biological descriptors resulted in two principal components which explained 46% of the variance. Component I appears to be related to conditions of eutrophia and metallic contamination and explains 28.8% of variance. Component II explains 17.2% of variance and seems to be related to herbivory, which is considerably more intense in shallow locations. Correspondance analysis applied to leaf epiphyte taxonomy of axis I and II explain 22% and 17.1% of the variance respectively. Axis I provide an ordering of locations that is related to existing water quality data, whilst axis II again seems to be related to herbivory. The two approaches are coherent with one another, and they both provide a good indication of water quality. The ordering of locations provided by both sets of descriptors is coherent with existing water quality data from the region. Even though the two approaches provide remarkably similar results, the combined set of biological indicators of the *Posidonia oceanica* ecosystem appears as a more powerful tool in the discrimination of medium-to-good water qualities. Meadows found in shallow waters are clearly influenced by internal forcings such as herbivory, which are in no apparent way related to water quality. For that reason, deeper meadows are recommended for use in any future monitoring studies.

PRELIMINARY PHYTOBENTHOS BIODIVERSITY STUDY OF MARINE SITES OF THE GREEK NATURA 2000 NETWORK

Maria PANTAZI¹, Panayotis PANAYOTIDIS,² Barbara Montasanto¹, Daniel Daneilidis¹ and Athamassis Economou¹

1 : Athens University, masters in oceanography,15784, Panepistimiopilis,Athens,GREECE

2 : National center of Marine Researcher, 19013 Mavro Lithari,Athens,GREECE

ABSTRACT

The implementation of the Directive 92/ 43/ EEC indicates the enactment of a European network of regions (sites) of special environmental management, known as "NATURA 2000". The Greek NATURA 2000 network consists of about 300 regions. Most of them present an important marine part.

The statistical analysis was based on phytobenthic data from the habitat type "reef" of 16 sites. The aim of the work was the hierarchical classification of the sites on the basis of phytobenthos biodiversity. The software used was PRIMER 5 and SPSS 11.

The Cluster analysis and the Multi Dimensional Scaling (MDS) were performed on a Bray Curtis Similarity matrix. The dissimilarity of the sites was checked, according to specific environmental factors (date, substrate, inclination, water depth, turbidity etc). Information concerning the number of species/site was gained by the use of Rank Correlation. Simper Analysis showed the percentage of the average dissimilarity/ similarity between different sites along with the species, which was considered responsible for this. Last but not least, a classification of the regions was attained, according to their biodiversity, by means of Diversity Analysis.

DESCRIPTORS OF *POSIDONIA OCEANICA* MEADOWS: TECHNICAL GUIDE FOR STANDARDIZED APPROACH

PERGENT-MARTINI Christine¹, LEONI Vanina¹, PASQUALINI Vanina¹, ARDIZZONE Giandomenico², BALESTRI Elena³, BEDINI Roberto⁴, BELLUSCIO Andrea², BELSHER Thomas⁵, BORG Joseph A.⁶, BOUDOURESQUE Charles François¹², BOUMAZA Salima⁷, BOUQUEGNEAU Jean Marie¹⁶, Branko , Maria Cristina⁹, CALVO Sebastiano¹⁰, CEBRIAN Just¹¹, CHARBONNEL Eric¹², CINELLI Francesco³, COSSU Andrea¹³, DURAL Berin¹⁴, FRANCOUR Patrice¹⁵, GOBERT Sylvie¹⁶, MOSTAFA Hesham¹⁷, LEPOINT Gilles¹⁶, MEINESZ Alexandre¹⁵, MOLENAAR Heike¹⁵, PANAYOTIS¹⁸, PEIRANO Andrea¹⁹, PERGENT Gérard¹, PIAZZI Luiggi³, RELINI Giulio²⁰, ROMERO Javier²¹, SANCHEZ-LIZASO Jose Luis²², SEMROUD Rachid⁷, SHEMBRI Patrick J.⁶, SHILI Abdessalem²³, VELIMIROV Branko⁸

1 Equipe «Ecosystèmes Littoraux», Faculté des Sciences et Techniques, Université de Corse, 20250 Corte, France ; 2 Université de Rome, Italie ; 3 Université de Pise, Italie ; 4 Institut de Biologie et d'Ecologie marine de Piombino, Italie ; 5 Ifremer, France ; 6 Université de Malte, Malte ; 7 ISMAL, Algérie ; 8 Université de Vienne, Autriche ; 9 Station zoologique de Naples, Italie ; 10 Université de Palerme, Italie ; 11 Marine Environmental Sciences Consortium, Alabama, USA ; 12 GIS Posidonie Université de Marseille, France ; 13 Université de Sassari, Italie ; 14 Université d'Ege, Turquie ; 15 Université de Nice, France ; 16 Université de Liège, Belgique ; 17 Université d'Alexandrie, Egypte ; 18 Institut d'océanographie, Grèce ; 19 ENEA, Italie ; 20 Université de Gènes, Italie ; 21 Université de Barcelone, Espagne ; 22 Université d'Alicante, Espagne ; 23 Le Bardo, Tunisie.

ABSTRACT

The management of the marine environment requires to possess information allowing to appreciate in a reliable way, the global quality of the environment. Resorting to biological indicators often appears as a way adapted to answer this type of problem. So, for a few years, a particular interest is granted to *Posidonia oceanica* meadows, because of their wide distribution over the littoral zone and because of the importance of these meadows within the conservation of the Mediterranean. It seems possible today to use this magnoliophyta to determine the quality of the coastal water.

A reasoned management, on the scale of the Mediterranean basin in general, requires standardized methods of study, applicable by the researchers and the administrators, and allowing obtaining comparable results. The aim of this study is to search for the different implemented methods used to study the health of *Posidonia oceanica*. To do it, a questionnaire was passed on to all the laboratories working in the domain. The results identify the parameters and their technical characteristics (e.g. protocol of implementation, presence/absence of standardization, interest and limits of use and pertinence of the acquired information) from the answers supplied by about thirty international scientists.

LES MICROATOLLS DE LA LAGUNE D'EL BIBAN : CARACTERISATION DE FACIES RARES D'HERBIERS A *POSIDONIA OCEANICA*

Selim Riveill¹, Hanem Djabou¹, Ramzi Hamrit² et Amor El Abed¹

¹ : Institut National des Sciences et Technologies de la Mer, Centres de La Goulette et de Zarzis

² : Centre de Formation Professionnel de la Pêche, Zarzis

RESUME

Posidonia oceanica (L.) Delile, inscrite sur la liste des espèces menacées de Méditerranée, forme des paysages remarquables, dont les microatolls considérés comme rares et aussi à protéger. Ce faciès d'herbier a été découvert sur une large étendue dans la lagune d'El Biban (Tunisie). N'étant précisément descriptible qu'à l'échelle métrique, 100 m² ont été microcartographiés pour en caractériser une parcelle type. Une méthode semi-fine (Carré Lissant de Densité Structurale), pour effectifs réduits, a ensuite été élaborée pour décrire des parcelles adjacentes. Le résultat obtenu est restitué pour ces deux méthodes complémentaires qui ont permis de décrire ces formations, précédemment signalées uniquement dans quatre autres secteurs de la Méditerranée.

KEY WORDS: *Posidonia oceanica* - microatolls - El Biban - Underwater mapping

DIVERSITE SPECIFIQUE DES PEUPELEMENTS PHYTOBENTHIQUES DE LA LAGUNE DE BOU GHRARA (TUNISIE MERIDIONALE)

Abdessalem SHILI ^{1,2} et Naceur BEN MAÏZ ³

¹ Laboratoire Ecosystèmes Aquatiques et Production, Institut National Agronomique de Tunisie. 43, avenue Charles Nicolle 1082, Tunis - Tunisie.

² Laboratoire de Diversité Biologique et Fonctionnement des Ecosystèmes Marins Côtiers. Faculté des Sciences de Luminy, Aix-Marseille II, France. abdessalemshili@yahoo.fr

³ Société de Promotion du Lac de Tunis, BP 36, EL Bouhaira 1080 Tunis Cedex.

Mots-clés : diversité spécifique, flore benthique, lagune de Boughrara.

Située dans la partie méridionale de la Tunisie et séparant l'île de Djerba du continent, la lagune de Boughrara constitue le plan d'eau lagunaire le plus étendu du pays, avec environ 50 000 hectares de superficie.

Les études consacrées aux peuplements phytobenthiques de la lagune de Boughrara sont relativement rares et datent de plus d'une vingtaine d'années. Les études réalisées en 1999-2000 dans le cadre du projet «Etude pour l'amélioration de la qualité des eaux de la lagune de Boughrara» ont permis de décrire l'état des lieux de la flore benthique de la lagune et d'évaluer la diversité spécifique récente de ce milieu. En effet, grâce à une prospection couvrant tous les secteurs de la lagune et des échantillonnages au niveau de près de 286 stations réparties le long de plusieurs transects parallèles, nous avons dressé en août 1999 une liste groupant 30 espèces de macrophytes benthiques, dont 10 Rhodophyceae, 7 Phaeophyceae, 11 Chlorophyceae et 2 Phanérogames. A côté de ces macrophytes, il a été observé des Cyanophycées benthiques, notamment *Microcoleus lyngbyaceus* formant des amas gélatineux très développés et couvrant des surfaces quelques fois très importantes.

Du point de vue répartition, les peuplements phytobenthiques se développent essentiellement au niveau du pourtour de la lagune et sont absents dans la partie centrale profonde qui représente près de 1/3 de la superficie totale de la lagune. Les macrophytes dominants sont représentés essentiellement par deux espèces : la phanérogame *Cymodocea nodosa* et l'algue *Caulerpa prolifera* qui apparaissent le plus souvent en peuplements distincts. La couverture totale de ces peuplements représente près de 68 % de la surface de la lagune. A côté de ces deux peuplements dominants, il faut noter la présence de touffes parfois très denses, de Cériamiacées du genre *Centroceras*, et des frondes isolés de *Cystoseira*, notamment dans le secteur Sud Est, des touffes de *Gracilaria* et de *Chondracanthus*, et quelques groupements de thalles d'algues vertes nitrophiles (*Ulva*, *Chaetomorpha*, *Cladophora*...) dans les zones limitrophes peu profondes. A l'entrée Nord-Ouest de la lagune, on note la présence de la phanérogame marine *Posidonia oceanica* sous forme de faisceaux peu denses et relativement isolés (pseudo-herbier très clairsemé) mais présentant parfois une matrice importante.

Par comparaison aux situations antérieures, les observations effectuées durant l'été 1999 montrent que la flore benthique de la lagune de Boughrara a subi plusieurs transformations durant les deux dernières décennies. Ces transformations ont abouti à une régression qualitative marquée par la disparition de certaines espèces à caractère franchement marin, l'apparition et l'extension d'algues libres saisonnières, la prolifération d'algues nitrophiles, notamment près des berges et la prolifération de Cyanophycées benthiques. Toutefois, la persistance de Posidonie et des Cystoseires dénote un état de lieu encore satisfaisant dans certains secteurs de la lagune.

PRELIMINARY RESULTS OF THE EPIBIOTIC FLORA
ON *EUNICELLA SINGULARIS* (GORGONACEA) COLONIES
FROM THE NORTH AEGEAN SEA

George SKOUFAS¹ & Anastasia TSIRIKA²

¹ Technological Educational Institute of Thessaloniki, Department of Fisheries Technology and Aquacultures, N. Miltiadi 1, GR- 623 00, Nea Moudania, Greece

² Aristotle University of Thessaloniki, Department of Biology, Institute of Botany, GR- 541 24, Thessaloniki, GREECE

ABSTRACT

The gorgonian branches denudation is described as necrosis. Gorgonian necrosis phenomena have been observed in tropical seas, as well as in the Mediterranean Sea. The denuded gorgonian branches offer an important hard substrate for the installation of a very rich epibiotic fauna and flora. However, gorgonian epibionts change hydrodynamical properties of the axis and water currents can uproot the colonies. Although the existence of epibiotic algae on denuded gorgonian branches has been recorded in the Mediterranean Sea, almost no data on the identity of those macroalgae species have been given. The aim of the present study is to report the dominant macroalgae species installed on the colonies of a *Eunicella singularis* gorgonian population that presented a mass mortality phenomenon in Arethoussa (Kavala bay, North Aegean Sea). The examined *Eunicella singularis* population expanded at a depth range between 5 and 15 meters. *In situ* observations at 350 gorgonian colonies showed that 342 (97.7%) colonies were affected by partial or total necrosis. Total necrosis and coverage of the denuded branches by epibiotic algae exhibited 287 (82%) colonies. In addition, 55 (15.7%) colonies presented partial mortality and exhibited both denuded and not denuded branches. Only 8 colonies from the investigated gorgonian population exhibited no mortality spots. Seasonal samples of approximately 15 colonies were collected with SCUBA-diving during 1997. The investigation of the epibiotic algae exhibited significant seasonal variations of the algae wet weight and algae coverage. The maximum of the algae wet weight was observed in spring and the maximum of the algae coverage during the summer. Furthermore, it was observed that the algae surface was remarkably bigger than the surface of the denuded gorgonian branches. The above algae features displayed a significant spearman correlation to the biometric parameters of the denuded branches. The dominant macroalgae species installed on the denuded branches were the red algae *Womersleyella setacea*, *Botryocladia botryoides*, *Faucea repens* and the brown algae *Sphacelaria plumula*, *Dictyopteris polypodioides*, *Dictyota dichotoma*, *Halopteris filicina*, *Stypocaulon scoparium* and *Zanardinia typus*. The red alga *Falkenbergia rufolanosa* (tetrasporophyte of *Asparagopsis armata*) was found as an epiphyte on *Womersleyella setacea* in all the seasons being remarkably abundant in winter. Another red alga, growing as an epiphyte and being recorded for the first time at Greek coasts in the present study, was *Trailiella intricata* (tetrasporophyte of *Bonnemaisonia hamifera*). This filamentous species was present throughout the year, forming dense tufts (up to 15 mm in diameter), on the brown alga *Dictyopteris polypodioides*.

CONTRIBUTION TO THE KNOWLEDGE OF THE BENTHIC MARINE MACROALGAE FROM MANI REGION (MESSINIAKOS GULF, GREECE)

Anastasia TSIRIKA, Dimitris PATOUCHEAS & Sawas HARITONIDIS

Aristotle University of Thessaloniki, Department of Biology, Institute of Botany, GR- 541 24, Thessaloniki, GREECE

ABSTRACT

Limited information is available on the benthic marine flora of Peloponnese and no data are provided for the Southwestern part of Mani region (Messiniakos Gulf). The current study, including certain biotopes of the Mani region (Hotassia, Oitilo and Aeropolis), aims at a broader contribution to the survey of the Greek marine flora. All sample collections were accomplished with SCUBA-diving during the spring and autumn of 2002 and 2003. The studied sites are characterized by the intense presence of hard substrate from 0m down to 50m depth, with the exception of few sandy coasts. Samples were collected from 0-2m and 35-40m depth. In total, the samples contained 147 taxa. From the identified species, the red algae dominate qualitatively with 99 representatives, whereas the phaeophyceae and green algae participate with 28 and 20 representatives, respectively. The *Cystoseira* spp. communities constitute a source of floristic richness on hard substrate, form a productive belt that plays an important ecological role and shape most of the rocky underwater landscape in the Mediterranean Sea. Concerning the depth of 0-2m, significant was the presence of the photophilus association of *Cystoseira amentacea* and the photophilus association of *Cystoseira compressa* accompanied by *Cystoseira barbatula* and *Chondrophycus papillosus*. Moreover, at the lower midlittoral and upper sublittoral zone the red alga *Tenarea tortuosa* covered extended areas. At the depth of 35-40m the association of *Cystoseira spinosa* and the association of *Cystoseira foeniculacea* f. *schiffneri* were recorded. At that depth very important was the presence of the brown alga *Sargassum acinarium* accompanied by dense populations of the epiphytic and epilithic *Callithamnion granulum*. All over the substrate at 35-40m depth dense turfs of the filamentous red macroalga *Womersleyella setacea* occurred. This species, described originally from the Hawaiian Islands and later reported from other tropical localities, has recently become widespread in the Mediterranean Sea. In Greece, it has been observed at North and South Aegean Sea. No sporangia or sexual reproductive structures were observed at the specimens of the studied site. Another pan-tropical to temperate-warm water species that is currently experiencing a dramatic and continuous spread throughout most of the Mediterranean Sea was recorded at the studied sites. The green alga *Caulerpa racemosa* occurred at 0-2m, as well as at 35-40m depth, expanding on rocky substrate, benthic fauna, encrusting algae as Corallinaceae and *Peyssonnelia* spp., turf species and erect algae. The species expansion was much more significant at deep water than at shallow water biocommunities. Specimens of *Caulerpa racemosa* from Mani region possessed uncrowded radial to distichous branchlets and the branchlets shape was clavate with rounded apex. The morphology of the specimens indicates that they belong to the invasive variety *Caulerpa racemosa* var. *occidentalis*. The species *Laurencia chondrioides* and *Osmundea pelagosae* are recorded for the first time at the Greek coasts in the present study. Both species were found to grow as epiphytes at the depth of 35-40m.

SECOND MEDITERRANEAN SYMPOSIUM
ON MARINE VEGETATION
Athens, 12-13 December 2003

LIST OF PARTICIPANTS

Mr Baris AKÇALI

D.E.U. Institute of Marine Sciences and
Technology
University of Dokuz Eylül
35340 Izmir
TURKEY
Tel: 90 232 278 65 25
Fax: 90 232 278 50 82
E-mail: baris.akcali@deu.edu.tr

Ms Teresa ALCOVERRO PEDROLA

Centre c'Estudis Avançats de Blanes
CSIC
c/acc. Cala S. Francesc 14
17300 Blanes
SPAIN
Tel: 34 972 336101
Fax: 34 972 337806
E-mail: teresa@ceab.csic.es

Ms Marina ARGYROU

Department of Fisheries and Marine
Research Marine Biology and Ecology
Section
Ministry of Agriculture, Natural Resources
and Environment
13, Aeolou Str.
1416 Nicosia
CYPRUS
Tel: 357 22 303 864
Fax: 357 22 775 955
E-mail: margyrou@cytanet.com.cy

Mr David BALATA

Scienze dell'Uomo e dell'Ambiente
University of Pisa
Via A. Volta 6
56 126 Pisa
ITALY
Tel: 39 05 0500 018
Fax: 39 05 0496 94

Mr Enrique BALLESTEROS

Centre d'Estudis Avançats de Blanes
(CEAB) - Consejo Superior de
Investigaciones Cientificas (CSIC)
C/ Accés Cala Sant Francesc 14
17300 Blanes, Girona
SPAIN
Tel: 34 97 2336 101
Fax: 34 97 2337 806
E-mail: kike@ceab.csic.es

Mr Thomas BELSHER

LER/LR
IFREMER
Avenue Jean Monnet - BP 171
34203 Sète CEDEX
FRANCE
Tel: 33 4 99 57 32 93/33 4 99 57 32
00/33 6 62 73 85 50
Fax: 33 4 99 57 32 96/33 4 99 57 32 94
E-mail: belsher@ifremer.fr

Mr Saïd BENHISSOUNE

Laboratoire d'Hydrobiologie
 Département Biologie
 Faculté des Sciences Agadir
 BP 403 Agadir Principale
 80 000 Agadir
 MAROC
 Tel: 212 48 22 09 57
 Fax: 212 48 22 01 00
 E-mail: benhissoune@hotmail.com;
 benhissoune@menara.net.ma

Mr Ghazi BITAR

Département Sciences Naturelles
 Université libanaise - Faculté des Sciences
 Hadath - Beyrouth
 LIBAN
 Tel: 961 3 315 162 / 961 5 801 395
 Fax: 961 5 465 562
 E-mail: ghbitar@ul.edu.lb

Ms Antonella BOTTALICO

Department of Biology and Plant
 Pathology
 University of Bari
 Via E. Orabona 4
 70 125 Bari
 ITALY
 Tel: 39 080 544 21 63
 Fax: 39 080 544 21 55
 E-mail: bottalico@botanica.uniba.it

Mr Charles-François BOUDOURESQUE

UMR 6540, Centre d'Océanologie de
 Marseille
 Université de la Méditerranée
 Campus de Luminy, case 901
 Avenue de Luminy
 13 2888 cedex 9 Marseille
 FRANCE
 Tel: 33 4 91 82 91 30
 Fax: 33 4 91 41 12 65
 E-mail: boudour@com.univ-mrs.fr

Ms Gianna CASAZZA

Water Department
 Agenzia la Protezione dell'Ambiente ed i
 servizi Tecnici (APAT)
 Via Vitaliano Brancati 48
 00144 Rome
 ITALY
 Tel: 39 06 5007 2838
 Fax: 39 06 50072221
 E-mail: casazza@apat.it

Ms Vassiliki-Angelique CATSIKI

Hellenic Center for Marine Research
 (NCMR)
 POB 712
 19013 Anavissos, Athens
 GREECE
 Tel: 22910 76371
 E-mail: cats@ncmr.gr

Mr Francesco CINELLI

President
 Environmental Sciences Faculty
 Dipartimento di Scienze dell'Uomo e
 dell'Ambiente University of Pisa
 Via A. Volta 6 56 126 Pisa - ITALY
 Tel: +39 050 22 13 345
 Fax: +39 050 496 94
 Mobile: +39 335 71 101 49
 E-mail1: cinelli@discat.unipi.it
 E-mail2: fcinelli@scamb.unipi.it

Mr Sükran CIRIK

Prof. Dr.
 D.E.U. Institute of Marine Sciences and
 Technology
 University of Dokuz Eylül
 35340 Izmir
 TURKEY
 Tel: 90 232 278 65 25
 Fax: 90 232 278 50 82
 E-mail: cirik@imst.deu.edu.tr;
 cirik@comu.edu.tr

Mr Francesco Saverio CIVILI

MED POL Coordinator
Coordinating Unit for the Mediterranean
Action
Plan, P. O. Box 18019
48, Vassileos Konstantinou Avenue
116 10 Athens
GREECE
Tel: 30 210 72 73 106
Fax: 30 210 72 53 196 / 7
E-mail: fscivili@unepmap.gr

Ms Sarah DEBONO

Nature Protection Unit
Environment Protection Directorate
Malta Environment & Planning Authority
P.O. Box 200
CMR 01 St. Francis Ravelin, Valletta
MALTA
Tel: 356 2290 6004
Fax: 356 2290 1585
E-mail: Sarah.Debono@mepa.org.mt

Ms Costanza Ilaria DELLE FOGLIE

Department of Biology and Plant
Pathology
University of Bari
Via E. Orabona 4
70 125 Bari
ITALY
Tel: 39 080 544 21 63
Fax: 39 080 544 21 55
E-mail: ilaria@botanica.uniba.it

Mr Andreas DEMETROPOULOS

Cyprus Wildlife Society
P.O. Box 24281
1703 Nicosia
CYPRUS
Tel: 357 22 350 316 / 357 22 354 089
Fax: 357 22 354089 / 357 22 453 938
E-mail: andrecws@logos.cy.net

Mr Aslam Sami DJELLOULI

Département de Biologie
Faculté des Sciences de Tunis
Campus Universitaire - El Manar
1002 Tunis
TUNISIE
Tel: 216 71 852 600
E-mail: aslamd2001@yahoo.fr

Mr Renaud DUPUY DE LA GRANDRIVE

Association de Défense de
l'Environnement et de la Nature des
pays d'Agde
Maison de la réserve - Domaine du
Grand Clavelet - Route nationale de Sète
34300 Agde
FRANCE
Tel: 33 4 67 01 60 23
Fax: 33 4 67 01 60 29
E-mail: adena-bagnas@tiscali.fr

Ms Souha EL ASMI

Regional Activity Centre for Specially
Protected Areas (RAC/SPA)
Boulevard de leader Yasser arafet
BP 337
1080 Tunis cedex - TUNISIE
Tel: 216 71 78 28 68 / 71 78 30 34
Fax: 216 71 78 28 68
E-mail: souha.asmi@rac-spa.org.tn

Ms Zohra EL ASMI-DJELLOULI

Département de Géologie
Faculté des Sciences de Tunis
Campus Universitaire - El Manar
1002 Tunis
TUNISIE
Tel: 216 98 62 73 71
E-mail: zohde2002@yahoo.fr

Ms Soumaya EL HERRY

Département des Sciences de la
Production Animale et de la Pêche
Institut National Agronomique de Tunisie
(INAT)
43, Avenue Charles Nicolle - Cité
Mahrajène
1082 Tunis
TUNISIE
Tel: 316 97 656 126
E-mail: herry.soumaya@inat.zzn.com

Mr Mathieu FOULQUIE

20, rue école de droit
34000 Montpellier
FRANCE
Tel: 33 4 67 92 81 67
Fax: 33 4 67 92 81 67
E-mail: mathieusp@worldonline.fr

Mr Giuseppe GIACCONE

Full professor (Phycology)
Department of Botany
University of Catania
Via A. Longo 19
95 125 Catania
ITALY
Tel: 39 09 5507 490 /
Mobile: 338 949 4324
Fax: 39 09 5441 209
E-mail: giaccone@mbox.dipbot.unict.it

Prof. Menachem GOREN

Department of Zoology
Tel Aviv University
Tel Aviv 69 778
ISRAEL
Tel: 972 3 6409389
Fax: 972 3 6409403
E-mail: gorenm@post.tau.ac.il

Mr Ivan GUALA

Laboratory of Benthic Ecology
Stazione Zoologica 'A. Dohrn' of Naples
Punta S. Pietro
80 077 Ischia
ITALY
Tel: 39 081 583 3505 / 991 410
Fax: 39 081 984 201
E-mail: guala@szn.it

Ms Myroula HADJICHRISTOPHOU

Department of Fisheries and Marine
Research
Ministry of Agriculture, Natural Resources
and Environment
13, Aeolou street - 1416 Nicosia
CYPRUS
Tel: 357 22 303 901
Fax: 357 22 775 955
E-mail: andrecws@logos.cy.net

Mr Amir IBRAHIM

Head of the High Institute of Marine
Research
Tishreen University
P.O.Box 2242
Lattakia
SYRIA
Tel: 963 41 428 690
Fax: 963 41 428 780
E-mail: tu-himr@scs-net.org

Ms Maria IKONOMOPOULOU

The Sea Turtle Protection Society of
Greece ARCHELON
Sea Turtle Rescue Centre
ARCHELON
Solomou 57
10432 Athens
GREECE
Tel: + 310 210 5231342, 898 2600
Fax: + 310 210 5231342, 898 2600
E-mail: rescue@archelon.gr

Mr Jamel KSOURI

Laboratoire de Biodiversité et
Biotechnologie Marine
Institut National des Sciences et
Technologies de la Mer (INSTM)
29, Rue du Général Khéreddine
2015 Le Kram
TUNISIE
Tel: 216 71 276 121
Fax: 216 71 732 622
E-mail: jamel.ksouri@instm.rnrt.tn

Ms Céline LAFABRIE

Equipe Ecosystèmes Littoraux (EqEL)
University of Corsica
BP 52
20250 Corte
FRANCE
Tel: 33 4 95 45 00 75
Fax: 33 4 95 46 24 41
E-mail: lafabrie@univ-corse.fr

Mr Habib LANGAR

Laboratoire de Biodiversité Marine
Institut National des Sciences et
Technologies de la Mer (INSTM)
28, Rue du 2 mars 1934
2025 Salammbô
TUNISIE
Tel: 216 71 73 04 20
Fax: 216 71 73 26 22
E-mail: habib.langar@instm.rnrt.tn

Mr Habib LITIM

Regional Activity Centre for Specially
Protected Areas (RAC/SPA)
Boulevard de l'Environnement - BP 337
1080 Tunis cedex
TUNISIE
Tel: 216 71 795 760
Fax: 216 71 797 349
E-mail: habib.litim@rac-spa.org.tn

Mr Mohamed Sofiène MAHJOUR

Département des Sciences de la
Production Animale et de la Pêche
Institut National Agronomique de Tunisie
(INAT)
43, Avenue Charles Nicolle - Cité
Mahrajène - 1082 Tunis
TUNISIE
Tel: 216 71 287 110
Fax: 216 71 799 391
E-mail: mahjoub_sofiene@yahoo.fr

Mr Tihomir MAKOVEC

Marine Biological Station Piran
National Institute of Biology
Fornace 41 - 6330 Piran
SLOVENIA
Tel: 386 5 674 6368
Fax: 386 5 674 6367
E-mail: makovec@mbss.org

Ms Luisa MANGIALAJO

Dipartimento per lo Studio del Territorio
e delle sue Risorse (DipTeRis)
Università di Genova
C.so Europa 26
16132 Genova
ITALIA
Tel: 39 01 0353 8382
Fax: 39 01 0353 8102
E-mail: luisama@dipteris.unige.it

Ms Helen MIHALATOU

Section of Biotic Resources and
Management of Protected Areas
The Goulandris Natural History Museum
Greek Biotope/Wetland Centre (EKBY)
14th Km Thessaloniki-Mihaniona,
57001 Thermi
GREECE
Tel: 30 2310 473 320
Fax: 30 2310 471 795
E-mail: mihalatu@ekby.gr

Mr Sotiris ORFANIDIS

National Agricultural Research
Foundation (NAGREF)
Fisheries Research Institute (FRI)
Nea Peramos
640 07 Kavala
GREECE
Tel: 30 2594 0 29039 / 22691-3
Fax: 30 2594 0 22222
E-mail: sorfanid@otenet.gr;
saorfan@otenet.gr

Mr Reuven ORTAL

Director
Department of Aquatic Ecology
Nature & Parks Authority
3 Am v'Olamot St.
95 463 Jerusalem
ISRAEL
Tel: 972 2 5005 444
Fax: 972 2 6529 232
E-mail: reuven.ortal@nature-parks.org.il

Mr V. PAPATHANASSIOU

Director
Institute of Oceanography
Hellenic Center for Marine Research
POB 712
19013 Anavissos, Athens
GREECE
Tel: 30 22 910 76371
Fax: 30 22 910 76347

Mr Panos PANAYOTIDIS

Institute of Oceanography
Hellenic Center for Marine Research
POB 712
19013 Anavissos, Athens
GREECE
Tel: 30 22 910 76371
Fax: 30 22 910 76347
E-mail: ppanag@ncmr.gr

Ms Maria PANTAZI

University of Athens
12 Menandrou Street, Agioi Anargyroi
13561 Athens
GREECE
Tel: 30 210 854 1626
E-mail: mairi_pa@hotmail.com

Mr Gérard PERGENT

EqEL
University of Corsica - BP 52
20250 Corte
FRANCE
Tel: 33 4 95 45 01 46
Fax: 33 4 95046 24 41
E-mail: pergent@univ-corse.fr

Ms Christine PERGENT-MARTINI

SEAGRASS 2000 - BP 52
20250 Corte
FRANCE
Tel: 33 4 95 45 00 55
Fax: 33 4 95 46 24 41
E-mail: pmartini@univ-corse.fr

Mr Luigi PIAZZI

Scienze dell'Uomo e dell'Ambiente
University of Pisa
Via A. Volta 6 - 56 126 Pisa
ITALY
Tel: 39 05 0500 018
Fax: 39 05 0496 94
E-mail: lpiazz@discat.unipi.it

Ms Susana PINEDO

Centre d'Estudis Avancats de Blanes
(CEAB) - Consejo Superior de
Investigaciones Cientificas (CSIC)
C/ Accés Cala Sant Francesc 14
17300 Blanes, Girona - SPAIN
Tel: 34 97 2336 101
Fax: 34 97 2337 806
E-mail: pinedo@ceab.csic.es

Mr Frédéric PLATINI

Accord RAMOGE
16, Boulevard de Suisse
98000 Monaco
MONACO
Tel: 377 93 15 42 29
Fax: 377 97 77 73 22
E-mail: ramoge@ramoge.org

Ms Anna PROIETTI ZOLLA

Scienze dell'Uomo e dell'Ambiente
University of Pisa
Via A. Volta 6
56 126 Pisa
ITALY
Tel: 39 05 0500 018
Fax: 39 05 0496 94

Mr Chedly RAIS

Regional Activity Centre for Specially
Protected Areas (RAC/SPA)
Boulevard de leader Yasser Arafet
BP 337
1080 Tunis cedex
TUNISIE
Tel: 216 71 78 30 34 / 71 78 28 68
Fax: 216 71 78 28 68
E-mail: chedly.rais@rac-spa.org.tn

Mr Alfonso RAMOS ESPLÁ

Departament de Ciències Ambientales
(Unidad de Biología Marina)
University of Alicante
Campus de San Vicente
03080 Alicante
SPAIN
Tel: 34 965 90 36 68
Fax: 34 965 90 34 64
E-mail: Alfonso.Ramos@ua.es

Mr Selim RIVEILL

Annexe de la Goulette
Institut National des Sciences et
Technologies de la Mer (INSTM)
Port de Pêche de la Goulette
2060 La Goulette - Tunis
TUNISIE
Tel: 216 71 735 848
Fax: 216 71 735 848
E-mail: selriv@melimail.com;
selim.riveill@instm.rnrt.tn

Ms Maria SALOMIDI

Institute of Oceanography
Hellenic Center for Marine Research
POB 712
19013 Anavyssos
GREECE
Tel: 30 229 1076 372
Fax: 30 229 1076 347
E-mail: msal@ncmr.gr

Mr Gianfranco SARTONI

Biologia Vegetale
Universita' di Firenze
50121 Firenze
ITALY
Tel: 39 055 2757 370
Fax: 39 055 2757 379
E-mail: gsartoni@unifi.it

Mr Rachid SEMROUD

Laboratoire de Biologie et de l'Ecologie
du Phytobenthos
Institut des Sciences de la Mer et de
l'Aménagement du Littoral (ISMAL)
BP 54, Plage ouest,
Sid-Fredj - Alger
ALGERIE
Tel: 213 2 138 8065 / 213 7 123 9483
Fax: 213 2 138 8065 / 213 7 123 9483
E-mail: rasem33@hotmail.com

Mr Abdessalem SHILI

Haliéutique
 Institut National Agronomique de Tunisie
 (INAT)
 43, Avenue Charles Nicolle
 1082 Tunis Mahrajène
 TUNISIE
 Tel: 216 22 534 167
 Fax: 216 71 351 334
 E-mail: abdessalemshili@yahoo.fr

Ms Cecilia SILVESTRI

Water Department
 Agenzia la Protezione dell'Ambiente ed i
 servizi Tecnici (APAT)
 Via Vitaliano Brancati 48
 00144 Rome
 ITALY
 Tel: 39 06 5007 2386
 Fax: 39 06 5007 2221
 E-mail: csilvestri@apat.it

Mr George SKOUFAS

Department of Fisheries Technology and
 Aquacultures
 Technological Educational Institute of
 Thessaloniki
 N. Miltiadi 1
 63200 N. Moudania
 GREECE
 Tel: 30s 2310-867608
 Fax: 30 2373 02645
 E-mail: gskoufas@hotmail.com

Mr Laurent SOURBES

Integrated Planning Department
 Marine National Park of Zakynthos
 Ktirio dimotikou diameriomatos ARGASIOU
 29100 Zakynthos
 GREECE
 Tel: 30 26950 29870
 Fax: 30 26950 29870
 E-mail: lsourbes@nmp.zak.org

Ms Emanuela SPADA

Water Department
 Agenzia la Protezione dell'Ambiente ed i
 servizi Tecnici (APAT)
 Via Vitaliano Brancati 48
 00144 Rome
 ITALY
 Tel: 39 06 5007 2361
 Fax: 39 06 5007 2221
 E-mail: spada@apat.it

Ms Sofie SPATHARIS

University of Athens & NCMR
 P. Tsaldari 13
 151 22 Marousi
 GREECE
 Tel: 30 210 6121 959
 E-mail: sofiaspathari@hotmail.com

Ms Rania SPYROPOULOU

Natural Environment Management Section
 Ministry for the Environment, Physical
 Planning and Public Works
 36, Trikalon Str.
 GR-115 26 Athens
 GREECE
 Tel: 30 210 691 8202
 Fax: 30 210 691 8487
 E-mail: s.spyropoulou@dpers.minenv.gr

Mr Xavier TORRAS

Centre d'Estudis Avancats de Blanes
 (CEAB) - Consejo Superior de
 Investigaciones Científicas (CSIC)
 C/ Accés Cala Sant Francesc 14
 17300 Blanes, Girona
 SPAIN
 Tel: 34 97 2336 101
 Fax: 34 97 2337 806
 E-mail: xtorras@ceab.csic.es

Ms Eleni TRYFON

Natural Environment Management
Section
Ministry for the Environment, Physical
Planning and Public Works
36, Trikalon Str.
GR-115 26 Athens
GREECE
Tel: 30 210 691 8202
Fax: 30 210 691 8487
E-mail: e.trifon@dpers.minenv.gr

Ms Anastasia TSIRIKA

Department of Biology
Aristotle University of Thessaloniki -
Institute of Botany
POB 109
GR- 54124 Thessaloniki
GREECE
Tel: 30 2310 998 376
Fax: 30 2310 998 389
E-mail: atsirika@bio.auth.gr

Mr Robert TURK

Institute of the Republic of Slovenia for
Nature Conservation
Regional Office Piran
Tartinijev trg 12
6330 Piran
SLOVENIA
Tel: 386 5 6710 901
Fax: 386 5 6710 905
E-mail: robert.turk@zrsvn.si

Ms Ioanna VARKITZI

Institute of Oceanography
Hellenic Center for Marine Research
POB 712
19013 Anavissos, Athens
GREECE
Tel: 30 229 1076 339
Fax: 30 229 1076 347
E-mail: ioanna@ath.hcmr.gr

Regional Activity Centre For Specially Protected Areas
(RAC/SPA)
Boulevard du Leader Yasser Arafat
B.P.337 - 1080 Tunis CEDEX - TUNISIA
e-mail: car-asp@rac-spa.org



Centre d'Activités Régionales pour les Aires Spécialement Protégées
(CAR/ASP)
Boulevard du Leader Yasser Arafat
B.P.337 - 1080 Tunis CEDEX - TUNISIE
e-mail: car-asp@rac-spa.org
